

CHANCE GUEST | Designed by Francisco Romero of PhiDesign



SPECIFICATIONS:

- Fully upholstered arm and armless models.
- Fully upholstered bariatric models with enhanced seat and back size also available.
- Arms feature black finish as standard.
- Silver arm finish also available. Please specify (-SA01) after model number and add \$32 list.
- Round tubular steel frame.
- Frame available in standard and premium finishes. See below for options.
- For custom finish colors, please contact client services for pricing.
- Available with glides or on casters.
- Chairs with glides or casters stack up to 4 high standing or 5 with dolly.
- Optional ganging device available.
- If cartoning is required, chairs are packaged in units of three (3). A \$20 List carton break charge will be applied for orders with only one or two chairs.
- Guest chairs feature 300 lb. weight capacity.
- Bariatric models feature 500 lb. weight capacity.
- Refer to terms and conditions for general information regarding fabrics, finishes, warranty, freight, complete condition of sales and more.

STANDARD METAL FRAME FINISH COLORS:

- 0405 Charcoal Grey
- 0535 Metallic Silver
- 0630 Satin Black

PREMIUM METAL FRAME FINISH COLORS:









- 0605 Matte Black
- 0705 Matte Cotton
- 0788 Glossy Cotton
- 0805 Oasis
- 0905 Mint
- 1005 Mercury
- 1105 Canary
- 1205 Stone
- 1305 Sage
- 1405 Ice Blue
- 1505 Clay

All shipments for this series will be blanket-wrapped as standard. For customers located in Territory 1 who require cartoning, a 5% upcharge will be added to each product. Please contact client services for additional information.

CHANCE GUEST | Designed by Francisco Romero of PhiDesign

ORDERING REQUIREMENTS:

- Model number
- Arm finish, as applicable
- Frame finish
- Upholstery selection
- Options, as applicable

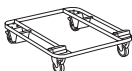
| MODEL | PRODUCT SPECIFICATIONS | FABRIC GRADES | | | | | | | | LEATHER | | | |
|--|---|---------------|-----|-----|-----|-----|-----|-------|-----|---------|-------|-------|-------|
| | | COM | A | 1 | 2 | 3 | 4 | COL 5 | 6 | 7 | 8 | L1 | L2 |
| 2510  |  Guest Chair, Fully Upholstered Arms, Glides 23.5" W x 23.5" D x 31" H Seat: 18.5" W x 18.5" D Seat Ht: 17.75" Arm Ht: 26" COM: 1.25 yds. COL: 25 sq. ft. 22 lbs. | 645 | 730 | 775 | 803 | 847 | 894 | 937 | 980 | 1,024 | 1,069 | 1,275 | 1,425 |
| 2515  |  Guest Chair, Fully Upholstered Arms, Casters 23.5" W x 23.5" D x 31" H Seat: 18.5" W x 18.5" D Seat Ht: 17.75" Arm Ht: 26" COM: 1.25 yds. COL: 25 sq. ft. 22 lbs. | 645 | 730 | 775 | 803 | 847 | 894 | 937 | 980 | 1,024 | 1,069 | 1,275 | 1,425 |
| 2530  |  Guest Chair, Fully Upholstered Armless, Glides 21" W x 23.5" D x 31" H Seat: 18.5" W x 18.5" D Seat Ht: 17.75" COM: 1.25 yds. COL: 25 sq. ft. 20 lbs. | 594 | 679 | 724 | 752 | 796 | 843 | 886 | 929 | 973 | 1,018 | 1,224 | 1,374 |
| 2535  |  Guest Chair, Fully Upholstered Armless, Casters 21" W x 23.5" D x 31" H Seat: 18.5" W x 18.5" D Seat Ht: 17.75" COM: 1.25 yds. COL: 25 sq. ft. 20 lbs. | 615 | 700 | 745 | 773 | 817 | 864 | 907 | 950 | 994 | 1,039 | 1,245 | 1,395 |
| 2500  | Dolly (Black Finish Only) 24" W x 30" D x 6" H 37 lbs. | 457 | | | | | | | | | | | |

OPTIONS

| | | | |
|-----------------------------------|-------|------------------------------------|------|
| -PFM02 Premium Metal Frame Finish | \$101 | -STC02 Soft Tread Casters | \$33 |
| -SA01 Silver Arms | \$32 | -VCT04 VCT Tile Glides | \$28 |
| -EF01 1" Additional Seat Foam | \$44 | -MB01 Moisture Barrier (seat only) | \$68 |
| -GCO1 Ganging Connector | \$42 | | |

 = Available on quick-ship program (0535 Metallic Silver base finish only).

All shipments for this series will be blanket-wrapped as standard. For customers located in Territory 1 who require cartoning, a 5% upcharge will be added to each product. Please contact client services for additional information.

CHANCE GUEST | Designed by Francisco Romero of PhiDesign

ORDERING REQUIREMENTS:

- Model number
- Arm finish, as applicable
- Frame finish
- Upholstery selection
- Options, as applicable

| MODEL | PRODUCT SPECIFICATIONS | FABRIC GRADES | | | | | | | | LEATHER | | | |
|--|--|---------------|-------|-------|-------|-------|-------|----------|-------|---------|-------|-------|-------|
| | | COM | A | 1 | 2 | 3 | 4 | COL 5 | 6 | 7 | 8 | L1 | L2 |
| 2580  | Bariatric Chair, Fully Upholstered Arms, Glides 34.5" W x 24.5" D x 32" H Seat: 30" W x 19" D Seat Ht: 18" Arm Ht: 26" COM: 2.5 yds. COL: 50 sq. ft. 50 lbs. | 1,326 | 1,496 | 1,586 | 1,641 | 1,729 | 1,824 | 1,909 | 1,996 | 2,084 | 2,174 | 2,586 | 2,886 |

OPTIONS

- PFM02 Premium Metal Frame Finish \$101
- SA01 Silver Arms \$32
- EF02 1" Additional Seat Foam \$98
- VCT04 VCT Tile Glides \$28
- MB02 Moisture Barrier (seat only) \$89

CHANCE GUEST | Designed by Francisco Romero of PhiDesign

UPHOLSTERY COMBINATIONS:

- For upholstery combinations, refer to the pricing below.
- When combining two COM/COV/COL fabrics, or fabrics with the same grade, add \$120 List per unit.
- When combining three or more COM/COV/COL fabrics, or fabrics with the same grade, add \$150 List per unit.
- When combining different grades of fabric, price will be based on the highest grade specified.
- Two-tone upholstery examples and yardage requirements for the most common combinations are listed below. Additional combinations available; please contact client services for yardage requirements and pricing.
- Note: Yardage amounts are based on fabric which is plain (i.e. non-directional) and a full 54" wide.
- Appropriate upholstery code must be included.



| Code | CS1 |
|--------------|------------------------|
| <u>Model</u> | <u>COM Requirement</u> |
| 2510 | Seat = .5 yd. |
| 2515 | Back = .75 yd. |
| 2530 | |
| 2535 | |



| Code | CS3 |
|--------------|------------------------|
| <u>Model</u> | <u>COM Requirement</u> |
| 2580 | Seat = 1.25 yds. |
| | Back = 1.25 yds. |

All shipments for this series will be blanket-wrapped as standard. For customers located in Territory 1 who require cartoning, a 5% upcharge will be added to each product. Please contact client services for additional information.

CHIRP GUEST



SPECIFICATIONS:

- Three base options available: sled base, swivel base with self-return or wood legs.
- Sled and swivel base available in standard and premium finishes. See below for options.
- For custom finish colors, please contact client services for pricing.
- 300 lb. weight capacity.
- Fixed wood legs offered in all standard finishes on Beech.
- For custom wood finishes, please add \$531 List per color per order.
- For Super Matte Sable Beech, premium wood finish upcharge applies. Refer to options section for pricing.
- All dimensions are nominal.
- Refer to terms and conditions for general information regarding fabrics, finishes, warranty, freight, complete condition of sales and more.

STANDARD METAL BASE FINISH COLORS:

- 0405 Charcoal Grey
- 0535 Metallic Silver
- 0199 Chrome (sled base only)
- 0299 Polished Aluminum (swivel base only)
- 0630 Satin Black

PREMIUM METAL BASE FINISH COLORS:



- 0605 Matte Black
- 0705 Matte Cotton
- 0788 Glossy Cotton
- 0805 Oasis
- 0905 Mint
- 1005 Mercury
- 1105 Canary
- 1205 Stone
- 1305 Sage
- 1405 Ice Blue
- 1505 Clay

All shipments for this series will be blanket-wrapped as standard. For customers located in Territory 1 who require cartoning, a 5% upcharge will be added to each product. Please contact client services for additional information.

CHIRP GUEST

ORDERING REQUIREMENTS:

- Model number
- Base finish
- Upholstery selection
- Options, as applicable

| MODEL | PRODUCT SPECIFICATIONS | FABRIC GRADES | | | | | | | | | | LEATHER | |
|---|--|---------------|-------|-------|-------|-------|-------|----------|-------|-------|-------|---------|-------|
| | | COM | A | 1 | 2 | 3 | 4 | COL 5 | 6 | 7 | 8 | L1 | L2 |
| 30112  | Guest Chair, Sled Base 21.75" W x 23" D x 32" H Seat: 19.75" W x 17" D Seat Ht: 18" COM: 1.5 yds. COL: 30 sq. ft. 18 lbs. | 1,160 | 1,262 | 1,316 | 1,349 | 1,402 | 1,459 | 1,510 | 1,562 | 1,615 | 1,669 | 1,916 | 2,096 |
| 30113  | Guest Chair, Swivel Base 20.5" W x 23" D x 31.75" H Seat: 19.75" W x 17" D Seat Ht: 17.75" COM: 1.5 yds. COL: 30 sq. ft. 22 lbs. | 1,332 | 1,434 | 1,488 | 1,521 | 1,574 | 1,631 | 1,682 | 1,734 | 1,787 | 1,841 | 2,088 | 2,268 |
| 30114  | Guest Chair, Wood Legs 20.5" W x 23" D x 31.75" H Seat: 19.75" W x 17" D Seat Ht: 17.75" COM: 1.5 yds. COL: 30 sq. ft. 17 lbs. | 1,382 | 1,484 | 1,538 | 1,571 | 1,624 | 1,681 | 1,732 | 1,784 | 1,837 | 1,891 | 2,138 | 2,318 |

OPTIONS

| | | |
|--------|--|-------|
| -PFM02 | Premium Metal Base Finish | \$101 |
| -PFW02 | Premium Wood Leg Finish | \$23 |
| -CGO2 | Clear Glides (sled base models only) | \$12 |
| -FGO4 | Felt Glides (sled base and wood leg models only) | \$26 |
| -NSO4 | Non-Skid Glides (sled base and wood leg models only) | \$26 |

CHIRP GUEST

UPHOLSTERY COMBINATIONS:

- For upholstery combinations, refer to the pricing below.
- When combining two COM/COV/COL fabrics, or fabrics with the same grade, add \$120 List per unit.
- When combining three or more COM/COV/COL fabrics, or fabrics with the same grade, add \$150 List per unit.
- When combining different grades of fabric, price will be based on the highest grade specified.
- Two-tone upholstery examples and yardage requirements for the most common combinations are listed below. Additional combinations available; please contact client services for yardage requirements and pricing.
- Note: Yardage amounts are based on fabric which is plain (i.e. non-directional) and a full 54" wide.
- Appropriate upholstery code must be included.



| Code | CH1 |
|--------------|---|
| <u>Model</u> | <u>COM Requirement</u> |
| All Models | Side/Front Panels = .75 yd. Balance of Chair = 1.25 yds. |



| Code | CH2 |
|--------------|---|
| <u>Model</u> | <u>COM Requirement</u> |
| All Models | Seat Front/Back Front = .75 yd. Balance of Chair = 1 yd. |



| Code | CH3 |
|--------------|---|
| <u>Model</u> | <u>COM Requirement</u> |
| All Models | Seat Front/Back Front/ Side & Front Panels = 1.25 yds. Balance of Chair = .75 yd. |

All shipments for this series will be blanket-wrapped as standard. For customers located in Territory 1 who require cartoning, a 5% upcharge will be added to each product. Please contact client services for additional information.

CHIRP STOOLS



SPECIFICATIONS:

- Bar and counter-height models.
- ½" diameter steel rod frame.
- Frame available in standard and premium finishes. See below for options.
- For custom finish colors, please contact client services for pricing.
- 30" bar-height stool features footrest with 11.5" clearance from the floor.
- 27" counter-height stool features footrest with 10" clearance from the floor.
- 300 lb. weight capacity.
- Optional glides for hard surface flooring.
- All dimensions are nominal.
- Refer to terms and conditions for general information regarding fabrics, finishes, warranty, freight, complete condition of sales and more.

STANDARD METAL FRAME FINISH COLORS:

- 0405 Charcoal Grey
- 0535 Metallic Silver
- 0199 Chrome (27" counter-height only)
- 0630 Satin Black

PREMIUM METAL FRAME FINISH COLORS:



- 0605 Matte Black
- 0705 Matte Cotton
- 0788 Glossy Cotton
- 0805 Oasis
- 0905 Mint
- 1005 Mercury
- 1105 Canary
- 1205 Stone
- 1305 Sage
- 1405 Ice Blue
- 1505 Clay

All shipments for this series will be blanket-wrapped as standard. For customers located in Territory 1 who require cartoning, a 5% upcharge will be added to each product. Please contact client services for additional information.

CHIRP STOOLS

ORDERING REQUIREMENTS:

- Model number
- Frame finish
- Upholstery selection
- Options, as applicable

| MODEL | PRODUCT SPECIFICATIONS | FABRIC GRADES | | | | | | | | | | LEATHER | |
|---|---|---------------|-------|-------|-------|-------|-------|----------|-------|-------|-------|---------|-------|
| | | COM | A | 1 | 2 | 3 | 4 | COL 5 | 6 | 7 | 8 | L1 | L2 |
| 30612-27  | Counter-Height Stool 19.75" W x 20.5" D x 35.5" H Seat: 16" W x 14" D Seat Ht: 27" COM: 1 yd. COL: 20 sq. ft. 14 lbs. | 1,167 | 1,235 | 1,271 | 1,293 | 1,328 | 1,366 | 1,400 | 1,435 | 1,470 | 1,506 | 1,671 | 1,791 |
| 30612-30  | Bar-Height Stool 19.75" W x 20.5" D x 38.5" H Seat: 16" W x 14" D Seat Ht: 30" COM: 1 yd. COL: 20 sq. ft. 16 lbs. | 1,188 | 1,256 | 1,292 | 1,314 | 1,349 | 1,387 | 1,421 | 1,456 | 1,491 | 1,527 | 1,692 | 1,812 |

OPTIONS

| | | |
|--------|----------------------------|-------|
| -PFM02 | Premium Metal Frame Finish | \$101 |
| -CG02 | Clear Glides | \$12 |
| -FG04 | Felt Glides | \$26 |

CHIRP STOOLS

UPHOLSTERY COMBINATIONS:

- For upholstery combinations, refer to the pricing below.
- When combining two COM/COV/COL fabrics, or fabrics with the same grade, add \$120 List per unit.
- When combining three or more COM/COV/COL fabrics, or fabrics with the same grade, add \$150 List per unit.
- When combining different grades of fabric, price will be based on the highest grade specified.
- Two-tone upholstery examples and yardage requirements for the most common combinations are listed below. Additional combinations available; please contact client services for yardage requirements and pricing.
- Note: Yardage amounts are based on fabric which is plain (i.e. non-directional) and a full 54" wide.
- Appropriate upholstery code must be included.



| | |
|--------------|--|
| Code | CH10 |
| <u>Model</u> | <u>COM Requirement</u> |
| All Models | Side/Front Panels = .5 yd. Balance of Chair = .75 yd. |



| | |
|--------------|---|
| Code | CH11 |
| <u>Model</u> | <u>COM Requirement</u> |
| All Models | Seat Front/Back Front = .5 yd. Balance of Chair = .5 yd. |



| | |
|--------------|--|
| Code | CH12 |
| <u>Model</u> | <u>COM Requirement</u> |
| All Models | Seat Front/Back Front/ Side & Front Panels = .75 yd. Balance of Chair = .5 yd. |

All shipments for this series will be blanket-wrapped as standard. For customers located in Territory 1 who require cartoning, a 5% upcharge will be added to each product. Please contact client services for additional information.

CIELO® OCCASIONAL TABLES | Designed by Chris Panichella



SPECIFICATIONS:

- Round and square top shapes.
- Pull-up table also available.
- Occasional tables offered with laminate, solid surface and glass top surface options.
- Pull-up table available in laminate and solid surface only.
- For standard wood grain laminate or solid black laminate tops, edge will match unless specified otherwise.
- For all other solid laminates, edge will be exposed plywood substrate with clear coat finish.
- Please note that for edge matching on custom laminates (wood grain or otherwise), a \$531 List upcharge will apply.
- Solid surface available in white only.
- Glass tops are back-painted white as standard and may be used as a writable surface with dry-erase markers.
- Back-painted glass and solid surface tops feature exposed plywood substrate edge with clear coat finish.
- Laminate available in all standard colors.
- For custom laminate options, add \$649 List per color per order. Pre-approval required, please contact client services.
- Laminate tops are 3/4" thick, solid surface tops are 1/2" thick and back-painted glass tops are 1/4" thick.
- Metal base available in standard and premium finishes. See below for options.
- For custom metal finish colors, please contact client services for pricing.
- All dimensions are nominal.
- Refer to terms and conditions for general information regarding finishes, warranty, freight, complete condition of sales and more.

STANDARD METAL BASE FINISH COLORS:

- 0405 Charcoal Grey
- 0535 Metallic Silver
- 0199 Chrome
- 0630 Satin Black

PREMIUM METAL BASE FINISH COLORS:

- 0605 Matte Black
- 0705 Matte Cotton
- 0788 Glossy Cotton
- 0805 Oasis
- 0905 Mint
- 1005 Mercury
- 1105 Canary
- 1205 Stone
- 1305 Sage
- 1405 Ice Blue
- 1505 Clay

All shipments for this series will be blanket-wrapped as standard. For customers located in Territory 1 who require cartoning, a 5% upcharge will be added to each product. Please contact client services for additional information.

CIELO® OCCASIONAL TABLES | Designed by Chris Panichella

ORDERING REQUIREMENTS:

- Model number
- Top surface material
- Top finish, as applicable
- Base finish
- Options, as applicable

| | MODEL | DIMENSIONS | LAMINATE TOP (-L) | SOLID SURFACE TOP (-SF) | BACK-PAINTED GLASS TOP (-GL) | WEIGHT |
|---|---|--|-------------------|-------------------------|------------------------------|--------------------|
|  | Round Table 8060-1818-() 8060-2218-() | 18" Dia. x 18" H 22" Dia. x 18" H | 1,268 1,338 | 1,455 1,670 | 1,355 1,452 | 11 lbs. 13 lbs. |
| | Square Table 8065-181818-() 8065-222218-() | 18" W x 18" D x 18" H 22" W x 22" D x 18" H | 1,221 1,259 | 1,408 1,591 | 1,311 1,373 | 13 lbs. 15 lbs. |

OPTIONS

- PFM02 Premium Metal Base Finish \$101
- NS04 Non-Skid Glides \$26

Note: Round solid surface and glass tops may vary slightly in size from the dimensions listed above. Please contact client services if exact dimensions are required.



 = Available on quick-ship program (laminates and glass tops with O535 Metallic Silver or O199 Chrome base finishes only).

All shipments for this series will be blanket-wrapped as standard. For customers located in Territory 1 who require cartoning, a 5% upcharge will be added to each product. Please contact client services for additional information.

CIELO® PULL-UP TABLE | Designed by Chris Panichella

ORDERING REQUIREMENTS:

- Model number
- Top surface material
- Top finish, as applicable
- Base finish
- Options, as applicable

| MODEL | DESCRIPTION | LAMINATE TOP (-L) | SOLID SURFACE TOP (-SF) | WEIGHT |
|---|---|-------------------|-------------------------|---------|
| 8055-()  |  Free-Standing Pull-Up Table 18" W x 14" D x 26.5" H | 1,102 | 1,258 | 16 lbs. |

OPTIONS

-PFM02 Premium Metal Base Finish \$101

 = Available on quick-ship program (laminated tops with 0535 Metallic Silver or 0199 Chrome base finishes only).

All shipments for this series will be blanket-wrapped as standard. For customers located in Territory 1 who require cartoning, a 5% upcharge will be added to each product. Please contact client services for additional information.

CLIPSE LOUNGE | Designed by 5d Studio



SPECIFICATIONS:

- Lounge, love seat and sofa models available with wood legs or platform base with metal legs.
- Wood legs available in all standard finishes on Ash.
- For custom wood finishes, please add \$531 List per color per order.
- For Alabaster and Super Matte Sable Ash, premium wood finish upcharge applies. Refer to options section for pricing.
- Platform base with metal legs available in standard and premium finishes. See following page for options.
- For custom metal finish colors, please contact client services for pricing.
- VCT tile glides available for hard surface floors. Please specify "-VCT04" after model number and add \$28 List per unit.
- Swivel base also offered.
- Swivel base is finished in stainless steel and features 360-degree turning radius with self-return.
- Standard and premium base finishes also offered on swivel base model.
- 350 lb. weight capacity.
- All dimensions are nominal.
- Refer to terms and conditions for general information regarding fabrics, finishes, warranty, freight, complete condition of sales and more.

ROTATING TABLET:

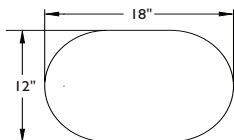

- Tablet affixed to right or left arm, as specified.
- Tablet size is 18" W x 12" D x .75" thick and features 360-degree turning radius.
- Two tablet surface options: Laminate and solid surface.
- Solid surface available in white only.
- Solid surface tops feature exposed plywood substrate edge with clear coat finish.
- For custom laminate options, add \$649 List per color per order. Pre-approval required, please contact client services.
- For standard wood grain laminate or solid black laminate tops, edge will match unless specified otherwise.
- For all other solid laminates, edge will be exposed plywood substrate with clear coat finish.
- Tablet mounting bracket features 0535 Metallic Silver finish as standard. 0630 Satin Black finish also available. Please specify.
- 100 lb. weight capacity.

CLIPSE LOUNGE | Designed by 5d Studio

POWER UNITS:

- Available on fixed leg models only (not available on swivel base version).
- Dimensions: 5.25" W x 4.25" L
- Touch latch lid provides easy access to electrical features.
- 72" electrical cord (no hardwire option available for this series).
- Unit will be positioned on right side, as seated, unless otherwise specified.
- If specified in conjunction with a tablet, power unit will be mounted to same side as tablet, unless otherwise specified.
- UL listed.

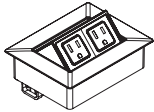

Portal Power 2 (PP2):

- Two outlets.
- Touch latch lid with metallic silver finish

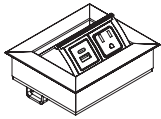

Portal Power 3 (PP3):

- One outlet, one USB-A and one USB-C charging ports.
- Touch latch lid with metallic silver finish

STANDARD METAL BASE FINISH COLORS:

- 0405 Charcoal Grey
- 0535 Metallic Silver
- 0199 Chrome (metal leg base only)
- 0399 Polished Stainless Steel (swivel base only)
- 0630 Satin Black

PREMIUM METAL BASE FINISH COLORS:



- 0605 Matte Black
- 0705 Matte Cotton
- 0788 Glossy Cotton
- 0805 Oasis
- 0905 Mint
- 1005 Mercury
- 1105 Canary
- 1205 Stone
- 1305 Sage
- 1405 Ice Blue
- 1505 Clay

All shipments for this series will be blanket-wrapped as standard. For customers located in Territory 1 who require cartoning, a 5% upcharge will be added to each product. Please contact client services for additional information.

CLIPSE LOUNGE | Designed by 5d Studio

ORDERING REQUIREMENTS:

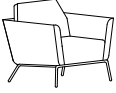
- Model number
- Base finish
- Upholstery selection
- Options, as applicable

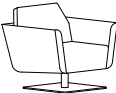
| MODEL | PRODUCT SPECIFICATIONS | FABRIC GRADES | | | | | | | | LEATHER | | | |
|--|---|---------------|-------|-------|-------|-------|-------|----------|-------|---------|-------|-------|-------|
| | | COM | A | 1 | 2 | 3 | 4 | COL 5 | 6 | 7 | 8 | L1 | L2 |
| 6270  |  Lounge Chair, Metal Legs 32" W x 29" D x 29.5" H Seat: 24" W x 20" D Seat Ht: 17.5" COM: 4 yds. COL: 80 sq. ft. 55 lbs. | 2,167 | 2,439 | 2,583 | 2,671 | 2,811 | 2,963 | 3,099 | 3,239 | 3,379 | 3,523 | 4,183 | 4,663 |
| 6270-W  | Lounge Chair, Wood Legs 32" W x 29" D x 29.5" H Seat: 24" W x 20" D Seat Ht: 17.5" COM: 4 yds. COL: 80 sq. ft. 55 lbs. | 2,297 | 2,569 | 2,713 | 2,801 | 2,941 | 3,093 | 3,229 | 3,369 | 3,509 | 3,653 | 4,313 | 4,793 |
| 6276  | Lounge Chair, Swivel Base 32" W x 29" D x 29.5" H Seat: 24" W x 20" D Seat Ht: 17.5" COM: 4 yds. COL: 80 sq. ft. 72 lbs. | 2,556 | 2,828 | 2,972 | 3,060 | 3,200 | 3,352 | 3,488 | 3,628 | 3,768 | 3,912 | 4,572 | 5,052 |

OPTIONS

| | | | | | |
|-----------|---|-------|--------|---|-------|
| -PFM02 | Premium Metal Base Finish, Fixed Metal Leg Models | \$101 | -PP2 | Portal Power 2 (dual power) | \$758 |
| -PFM04 | Premium Metal Base Finish, Swivel Base Models | \$172 | -PP3 | Portal Power 3 (1 power, 2 USB) | \$895 |
| -PFW01 | Premium Wood Leg Finish | \$12 | -NS04 | Non-Skid Glides (wood leg models only) | \$26 |
| -TAR01-L | Laminate Rotating Tablet, Right (as seated) | \$570 | -VCT04 | VCT Tile Glides (fixed metal leg models only) | \$28 |
| -TAL01-L | Laminate Rotating Tablet, Left (as seated) | | | | |
| -TAR01-SF | Solid Surface Rotating Tablet, Right (as seated) | \$683 | | | |
| -TAL01-SF | Solid Surface Rotating Tablet, Left (as seated) | | | | |





 = Available on quick-ship program (0535 Metallic Silver and 0199 Chrome base finishes only).

All shipments for this series will be blanket-wrapped as standard. For customers located in Territory 1 who require cartoning, a 5% upcharge will be added to each product. Please contact client services for additional information.

CLIPSE LOUNGE | Designed by 5d Studio

ORDERING REQUIREMENTS:

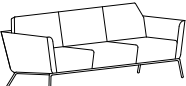
- Model number
- Base finish
- Upholstery selection
- Options, as applicable

| MODEL | PRODUCT SPECIFICATIONS | FABRIC GRADES | | | | | | | | | | LEATHER | |
|--|---|---------------|-------|-------|-------|-------|-------|----------|-------|-------|-------|---------|-------|
| | | COM | A | 1 | 2 | 3 | 4 | COL 5 | 6 | 7 | 8 | L1 | L2 |
| 6280  | Love Seat, Metal Legs 58" W x 29" D x 29.5" H Seat: 49" W x 20" D Seat Ht: 17.5" COM: 5.5 yds. COL: 110 sq. ft. 85 lbs. | 3,031 | 3,405 | 3,603 | 3,724 | 3,917 | 4,126 | 4,313 | 4,505 | 4,698 | 4,896 | 5,803 | 6,463 |
| 6280-W  | Love Seat, Wood Legs 58" W x 29" D x 29.5" H Seat: 49" W x 20" D Seat Ht: 17.5" COM: 5.5 yds. COL: 110 sq. ft. 85 lbs. | 3,187 | 3,561 | 3,759 | 3,880 | 4,073 | 4,282 | 4,469 | 4,661 | 4,854 | 5,052 | 5,959 | 6,619 |
| 6290  | Sofa, Metal Legs 81.5" W x 29" D x 29.5" H Seat: 73" W x 20" D Seat Ht: 17.5" COM: 7.25 yds. COL: 145 sq. ft. 130 lbs. | 4,295 | 4,788 | 5,049 | 5,209 | 5,463 | 5,738 | 5,985 | 6,238 | 6,492 | 6,753 | 7,949 | 8,819 |
| 6290-W  | Sofa, Wood Legs 81.5" W x 29" D x 29.5" H Seat: 73" W x 20" D Seat Ht: 17.5" COM: 7.25 yds. COL: 145 sq. ft. 130 lbs. | 4,361 | 4,854 | 5,115 | 5,275 | 5,529 | 5,804 | 6,051 | 6,304 | 6,558 | 6,819 | 8,015 | 8,885 |

OPTIONS

| | | | | | |
|-----------|--|-------|--------|---|-------|
| -PFM02 | Premium Metal Base Finish | \$101 | -PP2 | Portal Power 2 (dual power) | \$758 |
| -PFW01 | Premium Wood Leg Finish | \$12 | -PP3 | Portal Power 3 (1 power, 2 USB) | \$895 |
| -TAR01-L | Laminate Rotating Tablet, Right (as seated) | \$570 | -NS04 | Non-Skid Glides (wood leg models only) | \$26 |
| -TAL01-L | Laminate Rotating Tablet, Left (as seated) | | -VCT04 | VCT Tile Glides (fixed metal leg models only) | \$28 |
| -TAR01-SF | Solid Surface Rotating Tablet, Right (as seated) | \$683 | | | |
| -TAL01-SF | Solid Surface Rotating Tablet, Left (as seated) | | | | |

CLIPSE LOUNGE | Designed by 5d Studio

UPHOLSTERY COMBINATIONS:

- For upholstery combinations, refer to the pricing below.
- When combining two COM/COV/COL fabrics, or fabrics with the same grade, add \$120 List per unit.
- When combining three or more COM/COV/COL fabrics, or fabrics with the same grade, add \$150 List per unit.
- When combining different grades of fabric, price will be based on the highest grade specified.
- Two-tone upholstery examples and yardage requirements for the most common combinations are listed below. Additional combinations available; please contact client services for yardage requirements and pricing.
- Note: Yardage amounts are based on fabric which is plain (i.e. non-directional) and a full 54" wide.
- Appropriate upholstery code must be included.

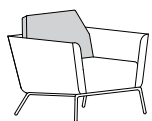

| Code | CL1 |
|--------------|-------------------------------|
| <u>Model</u> | <u>COM Requirement</u> |
| 6270 | Back Cushion Only = 1.25 yds. |
| 6270-W | Balance of Chair = 3.5 yds. |
| 6276 | |

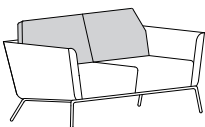

| Code | CL2 |
|--------------|----------------------------------|
| <u>Model</u> | <u>COM Requirement</u> |
| 6280 | Back Cushion Only = 1.75 yds. |
| 6280-W | Balance of Love Seat = 4.25 yds. |

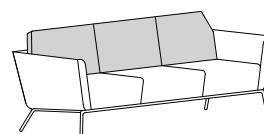

| Code | CL3 |
|--------------|-------------------------------|
| <u>Model</u> | <u>COM Requirement</u> |
| 6290 | Back Cushion Only = 2.25 yds. |
| 6290-W | Balance of Sofa = 5.5 yds. |

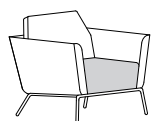

| Code | CL4 |
|--------------|-------------------------------|
| <u>Model</u> | <u>COM Requirement</u> |
| 6270 | Seat Cushion Only = 1.25 yds. |
| 6270-W | Balance of Chair = 3 yds. |
| 6276 | |

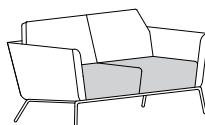

| Code | CL5 |
|--------------|-------------------------------|
| <u>Model</u> | <u>COM Requirement</u> |
| 6280 | Seat Cushion Only = 1.75 yds. |
| 6280-W | Balance of Love Seat = 4 yds. |

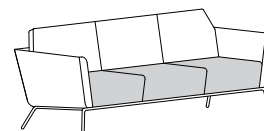

| Code | CL6 |
|--------------|------------------------------|
| <u>Model</u> | <u>COM Requirement</u> |
| 6290 | Seat Cushion Only = 2.5 yds. |
| 6290-W | Balance of Sofa = 5 yds. |

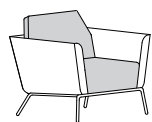

| Code | CL7 |
|--------------|------------------------------|
| <u>Model</u> | <u>COM Requirement</u> |
| 6270 | Back & Seat Cushion = 2 yds. |
| 6270-W | Balance of Chair = 2.75 yds. |
| 6276 | |

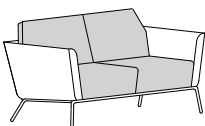

| Code | CL8 |
|--------------|---------------------------------|
| <u>Model</u> | <u>COM Requirement</u> |
| 6280 | Back & Seat Cushion = 3.25 yds. |
| 6280-W | Balance of Love Seat = 2.5 yds. |

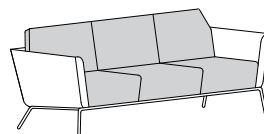

| Code | CL9 |
|--------------|--------------------------------|
| <u>Model</u> | <u>COM Requirement</u> |
| 6290 | Back & Seat Cushion = 4.5 yds. |
| 6290-W | Balance of Sofa = 3.25 yds. |

Encore will determine best shipping method, whether blanket-wrapped or cartoned, based on unit quantity and destination. If cartoning is required, a 10% upcharge will be added to each product. Please contact client services for additional information.

CROMO MEETING TABLES | Designed by CLAUDIO BELLINI Studio



PRODUCT FEATURES:

- Available in two heights: 29" and 42".
- Base tube diameter: 1.5".
- Table lengths of 120" and greater will feature a center leg for added stability.
- Ships KD. Assembly required.
- To ship fully assembled, set-up charge will be \$500 List per unit.
- Please note that Canadian shipments are unable to be shipped blanket-wrapped and a 20% cartoning surcharge will always apply.
- Optional power units available. Please refer to page 2 for options.
- All dimensions are nominal.
- Refer to terms and conditions for general information regarding finishes, warranty, freight, complete condition of sales and more.

SPECIFICATIONS:

- Table tops offered in White Oak and Walnut veneer as well as laminate, Fenix®, solid surface and Corian® selections.
- 1" top thickness for veneer, laminate and Fenix® selections. Solid surface and Corian® are affixed to table top surface, increasing the overall table thickness by 1/2".
- Premium wood finish upcharge applies to the following wood finishes. Refer to options section for pricing.
 - Alabaster Oak
 - Super Matte Sable Oak
- For custom wood finishes, please contact client services and add one-time upcharge of \$531 List per color per order.
- Laminate available in all standard colors.
- For custom laminate options, add \$649 List per color per order. Pre-approval required, please contact client services.
- Unless specified, veneer and laminate wood grain direction will run lengthwise on all top sizes.
- Fenix® offered in five standard colorways.
- For non-standard Fenix® colors, please contact client services for pricing.
- Metal base available in standard and premium finishes. See following page for options.
- For custom metal finish colors, please contact client services for pricing.

Encore will determine best shipping method, whether blanket-wrapped or cartoned, based on unit quantity and destination. If cartoning is required, a 10% upcharge will be added to each product. Please contact client services for additional information.

CROMO MEETING TABLES | Designed by CLAUDIO BELLINI Studio

TABLE EDGE SPECIFICATIONS:

- For veneer, edge finish will always match the top finish color, unless otherwise specified.
- For wood grain and solid black laminates, as well as Fenix® Nero Ingo (black), edge will match the top color, unless otherwise specified.
- For all other solid color laminates and Fenix® options, as well as solid surface and Corian®, edge finish will be natural (clear coat) as standard, unless otherwise specified.
- Edges are also available in all standard wood finishes, please specify. For custom edge finishes (e.g. to match standard solid color laminates), please add one-time upcharge of \$531 List per color, per order.
- For Corian® tops, an $\frac{1}{8}$ " reveal will be present.

FENIX COLORS:

- Bianco Kos
- Nero Ingo
- Grigio Efeso
- Grigio Londra
- Grigio Bromo

CORIAN COLORS:

- CWN Designer White
- CLN Linen
- CTD Witch Hazel
- CRC Rain Cloud
- CGQ Grey Onyx
- CSQ Stonique

STANDARD METAL BASE FINISHES:

- 0405 Charcoal Grey
- 0535 Metallic Silver
- 0630 Satin Black

PREMIUM METAL BASE FINISHES:

- 0605 Matte Black
- 0705 Matte Cotton
- 0788 Glossy Cotton
- 0805 Oasis
- 0905 Mint
- 1005 Mercury
- 1105 Canary
- 1205 Stone
- 1305 Sage
- 1405 Ice Blue
- 1505 Clay

POWER UNITS:

- Available on all models.
- Black or White finish with 120" electrical cord (no hardwire option available for this series).
- UL listed.



PX3
5.875" W x 2.875" D
One outlet, one USB-A and one USB-C charging port

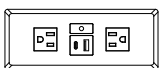

PX4
7.25" W x 2.875" D
Two outlets, one USB-A and one USB-C charging port



- Refer to page 4 for power unit standard locations.

Encore will determine best shipping method, whether blanket-wrapped or cartoned, based on unit quantity and destination. If cartoning is required, a 10% upcharge will be added to each product. Please contact client services for additional information.

CROMO MEETING TABLES | Designed by CLAUDIO BELLINI Studio

ORDERING REQUIREMENTS:

- Model number
- Surface material
- Surface finish
- Metal finish
- Options, as applicable

| MODEL | DIMENSIONS | VENEER (-V) | LAMINATE (-L) | FENIX (-FE) | SOLID SURFACE (-SF) | CORIAN (-CO) | WEIGHT <small>veneer and laminate/Fenix tables only</small> |
|---|------------------------|-------------|---------------|-------------|---------------------|--------------|--|
|  | | | | | | | |
| 29" H, Single Piece Top | | | | | | | |
| 9025-428429 | 42" D x 84" L x 29" H | 4,718 | 4,120 | 5,248 | 6,840 | 9,094 | 126 lbs. |
| 9025-429629 | 42" D x 96" L x 29" H | 5,130 | 4,448 | 5,737 | 7,556 | 10,132 | 137 lbs. |
| 9025-488429 | 48" D x 84" L x 29" H | 5,041 | 4,369 | 5,658 | 7,477 | 10,053 | 145 lbs. |
| 9025-489629 | 48" D x 96" L x 29" H | 5,559 | 4,801 | 6,274 | 8,353 | 11,297 | 151 lbs. |
|  | | | | | | | |
| 29" H, Two-Piece Top | | | | | | | |
| 9025-4212029 | 42" D x 120" L x 29" H | 6,244 | 5,422 | 7,033 | 9,307 | 12,527 | 200 lbs. |
| 9025-4214429 | 42" D x 144" L x 29" H | 7,074 | 6,102 | 8,035 | 10,764 | 14,628 | 230 lbs. |
| 9025-4812029 | 48" D x 120" L x 29" H | 6,737 | 5,809 | 7,650 | 10,249 | 13,929 | 219 lbs. |
| 9025-4814429 | 48" D x 144" L x 29" H | 7,711 | 6,612 | 8,821 | 11,940 | 16,356 | 245 lbs. |
|  | | | | | | | |
| 42" H, Single Piece Top | | | | | | | |
| 9025-246042 | 24" D x 60" L x 42" H | 3,432 | 3,144 | 3,605 | 4,254 | 8,132 | 82 lbs. |
| 9025-247242 | 24" D x 72" L x 42" H | 3,754 | 3,423 | 3,976 | 4,755 | 6,805 | 89 lbs. |
| 9025-249642 | 24" D x 96" L x 42" H | 4,183 | 3,766 | 4,503 | 5,542 | 8,049 | 106 lbs. |
| 9025-306042 | 30" D x 60" L x 42" H | 3,770 | 3,429 | 4,005 | 4,817 | 8,347 | 90 lbs. |
| 9025-307242 | 30" D x 72" L x 42" H | 4,124 | 3,729 | 4,420 | 5,394 | 9,657 | 98 lbs. |
| 9025-309642 | 30" D x 96" L x 42" H | 4,632 | 4,131 | 5,052 | 6,351 | 7,204 | 120 lbs. |
| 9025-366042 | 36" D x 60" L x 42" H | 4,109 | 3,832 | 4,523 | 5,497 | 6,468 | 98 lbs. |
| 9025-367242 | 36" D x 72" L x 42" H | 4,494 | 4,035 | 4,864 | 6,033 | 7,420 | 108 lbs. |
| 9025-369642 | 36" D x 96" L x 42" H | 5,066 | 4,479 | 5,584 | 7,143 | 8,301 | 134 lbs. |

OPTIONS

| | | |
|----------|---|-------|
| -PFM02 | Premium Metal Finish | \$101 |
| -PFW06 | Premium Wood Finish | \$311 |
| -PX3-() | Power Matrix 3 (one power, one USB-A, one USB-C) | \$534 |
| -PX4-() | Power Matrix 4 (dual power, one USB-A, one USB-C) | \$559 |

Encore will determine best shipping method, whether blanket-wrapped or cartoned, based on unit quantity and destination. If cartoning is required, a 10% upcharge will be added to each product. Please contact client services for additional information.

CROMO MEETING TABLES | Designed by CLAUDIO BELLINI Studio

Power Unit Standard Locations

1 Power Unit

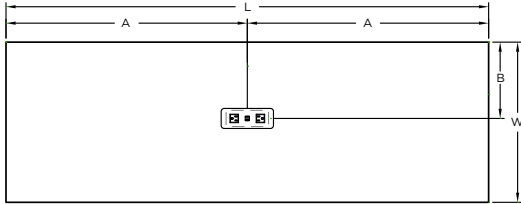

| D x L | A | B |
|-----------|-----|-----|
| 24" x 60" | 30" | 12" |
| 24" x 72" | 36" | 12" |
| 24" x 96" | 48" | 12" |
| 30" x 60" | 30" | 15" |
| 30" x 72" | 36" | 15" |
| 30" x 96" | 48" | 15" |
| 36" x 60" | 30" | 18" |
| 36" x 72" | 36" | 18" |
| 36" x 96" | 48" | 18" |
| 42" x 84" | 42" | 21" |
| 42" x 96" | 48" | 21" |
| 48" x 84" | 42" | 24" |
| 48" x 96" | 48" | 24" |

2 Power Units

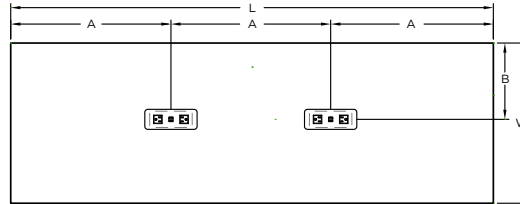

| D x L | A | B |
|------------|-----|-----|
| 24" x 60" | 20" | 12" |
| 24" x 72" | 24" | 12" |
| 24" x 96" | 32" | 12" |
| 30" x 60" | 20" | 15" |
| 30" x 72" | 24" | 15" |
| 30" x 96" | 32" | 15" |
| 36" x 60" | 20" | 18" |
| 36" x 72" | 24" | 18" |
| 36" x 96" | 32" | 18" |
| 42" x 84" | 28" | 21" |
| 42" x 96" | 32" | 21" |
| 42" x 120" | 40" | 21" |
| 42" x 144" | 48" | 21" |
| 48" x 84" | 28" | 24" |
| 48" x 96" | 32" | 24" |
| 48" x 120" | 40" | 24" |
| 48" x 144" | 48" | 24" |

For tables 120" and over, single power unit cannot be centered on tops due to center base placement. Please specify location as applicable.

Encore will determine best shipping method, whether blanket-wrapped or cartoned, based on unit quantity and destination. If cartoning is required, a 10% upcharge will be added to each product. Please contact client services for additional information.

CROMO MULTIPURPOSE TABLES | Designed by CLAUDIO BELLINI Studio



PRODUCT FEATURES:

- Flip-up and fixed top tables.
- Fixed tables available with glides or casters.
- Flip-up tables offered with casters only and feature a twist-and-release mechanism for quick and easy set-up and storage.
- All casters feature locking capability.
- Base tube diameter: 1.5".
- Ships KD. Assembly required.
- To ship fully assembled, set-up charge will be \$500 List per unit.
- Please note that Canadian shipments are unable to be shipped blanket-wrapped and a 20% cartoning surcharge will always apply.
- Optional power units available. Please refer to page 6 for options.
- All dimensions are nominal.
- Refer to terms and conditions for general information regarding finishes, warranty, freight, complete condition of sales and more.

SPECIFICATIONS:

- Table tops offered in White Oak and Walnut veneer as well as laminate and Fenix® selections.
- .75" top thickness.
- Premium wood finish upcharge applies to the following wood finishes. Refer to options section for pricing.
 - Alabaster Oak
 - Super Matte Sable Oak
- For custom wood finishes, please contact client services and add one-time upcharge of \$531 List per color per order.
- Laminate available in all standard colors.
- For custom laminate options, add \$649 List per color per order. Pre-approval required, please contact client services.
- Unless specified, veneer and laminate wood grain direction will run lengthwise on all top sizes.
- Fenix® offered in five standard colorways.
- For non-standard Fenix® colors, please contact client services for pricing.
- Metal base available in standard and premium finishes. See following page for options.
- For custom metal finish colors, please contact client services for pricing.

Encore will determine best shipping method, whether blanket-wrapped or cartoned, based on unit quantity and destination. If cartoning is required, a 10% upcharge will be added to each product. Please contact client services for additional information.

CROMO MULTIPURPOSE TABLES | Designed by CLAUDIO BELLINI Studio

TABLE EDGE SPECIFICATIONS:

- For veneer, edge finish will always match the top finish color, unless otherwise specified.
- For wood grain and solid black laminates, as well as Fenix® Nero Ingo (black), edge will match the top color, unless otherwise specified.
- For all other solid color laminates and Fenix®, edge finish will be natural (clear coat) as standard, unless otherwise specified.
- Edges are also available in all standard wood finishes, please specify. For custom edge finishes (e.g. to match standard solid color laminates), please add one-time upcharge of \$531 List per color, per order.

FENIX COLORS:

- Bianco Kos
- Nero Ingo
- Grigio Efeso
- Grigio Londra
- Grigio Bromo

STANDARD METAL BASE FINISHES:

- 0405 Charcoal Grey
- 0535 Metallic Silver
- 0630 Satin Black

PREMIUM METAL BASE FINISHES:

- 0605 Matte Black
- 0705 Matte Cotton
- 0788 Glossy Cotton
- 0805 Oasis
- 0905 Mint
- 1005 Mercury
- 1105 Canary
- 1205 Stone
- 1305 Sage
- 1405 Ice Blue
- 1505 Clay

CONNECTING TABLE MECHANISM FEATURES:

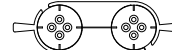
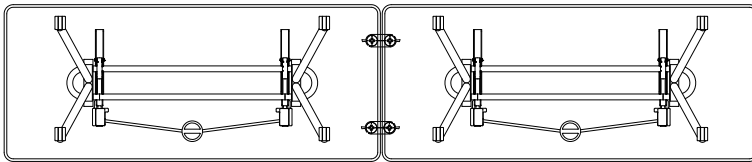

Ganging mechanism, locked
(2 units above are included per set).

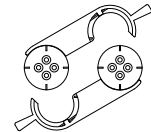

Ganging mechanism, unlocked.

- Ordered separately, ganging mechanism comes two per set to connect two tables together (end-to-end, side-to-side, end-to-side, etc.).
- Please include layout drawings or sketch with each order to ensure proper ganging bracket placement location.

MODESTY PANEL PRODUCT FEATURES:

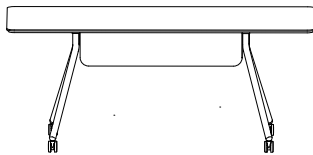

- 9.5" high x 37.875" wide panel available on fixed and flip-up tables.
- 1/2" thick PET material, heathered charcoal grey as standard.
- In-field installation required.

Encore will determine best shipping method, whether blanket-wrapped or cartoned, based on unit quantity and destination. If cartoning is required, a 10% upcharge will be added to each product. Please contact client services for additional information.

CROMO MULTIPURPOSE TABLES | Designed by CLAUDIO BELLINI Studio

POWER UNITS:

- Available on all models and clamps onto edge of table-top.
- White finish with 72" or 120" electrical cord (no hardwire option available for this series).
- UL listed.
- Adjustable bands for vertical wire management included when power is specified.

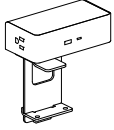

SPM
5" W x 3.5" D x 1.75" H
Two outlets, one USB-A and one USB-C charging port

DAISY CHAIN ELECTRICAL SPECIFICATIONS:

- Daisy chain units are required for end-to-end or ganging connections, as well as when two electrical units are specified on one top.
- To determine jumper cable length, measure length from edge of electrical unit to end of table.
- Ganging connectors are required for all daisy chain applications.
- Refer to page 7 for options and pricing.
- Note: Always disconnect cables prior to separating tables.

Encore will determine best shipping method, whether blanket-wrapped or cartoned, based on unit quantity and destination. If cartoning is required, a 10% upcharge will be added to each product. Please contact client services for additional information.

CROMO MULTIPURPOSE TABLES | Designed by CLAUDIO BELLINI Studio

TABLE NESTING DIMENSIONS (BASED ON 72" TABLE LENGTH).

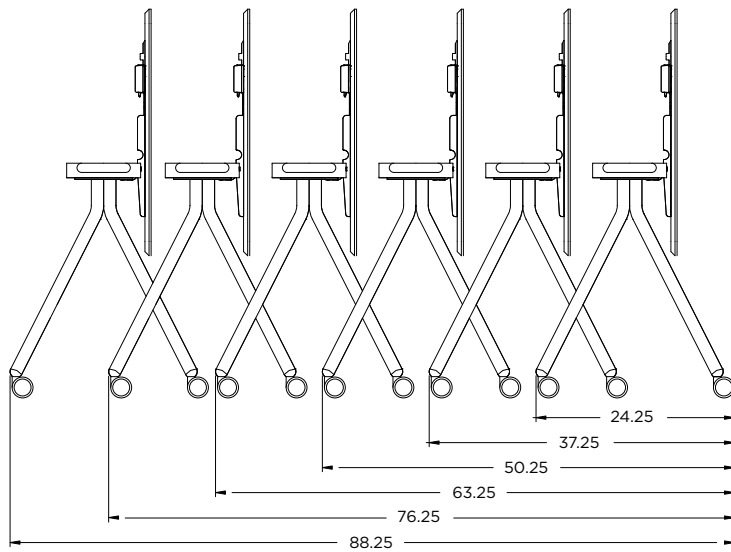
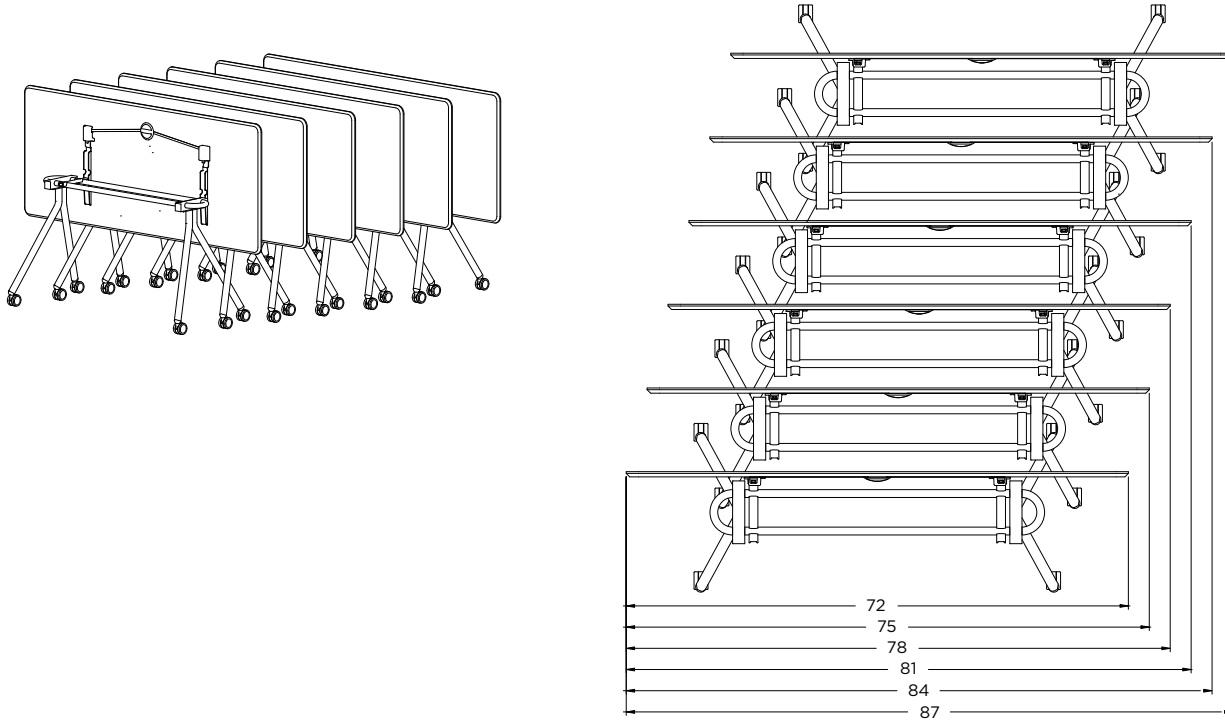



Encore will determine best shipping method, whether blanket-wrapped or cartoned, based on unit quantity and destination. If cartoning is required, a 10% upcharge will be added to each product. Please contact client services for additional information.

CROMO MULTIPURPOSE TABLES | Designed by CLAUDIO BELLINI Studio

ORDERING REQUIREMENTS:

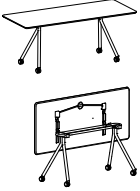
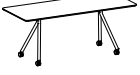
- Model number
- Surface material
- Surface finish
- Metal finish
- Options, as applicable

| MODEL | DIMENSIONS | veneer (-V) | laminate (-L) | fenix (-FE) | weight | |
|--|-------------|-----------------------|---------------|-------------|--------|---------|
|  <p>Flip-Up Top, Casters</p> | 9020-246029 | 24" D x 60" L x 29" H | 3,648 | 3,398 | 3,859 | 66 lbs. |
| | 9020-247229 | 24" D x 72" L x 29" H | 3,935 | 3,652 | 4,205 | 70 lbs. |
| | 9020-306029 | 30" D x 60" L x 29" H | 3,965 | 3,672 | 4,248 | 71 lbs. |
| | 9020-307229 | 30" D x 72" L x 29" H | 4,282 | 3,946 | 4,637 | 77 lbs. |
|  <p>Fixed Top, Casters</p> | 9021-246029 | 24" D x 60" L x 29" H | 3,008 | 2,759 | 3,220 | 66 lbs. |
| | 9021-247229 | 24" D x 72" L x 29" H | 3,380 | 3,097 | 3,650 | 70 lbs. |
| | 9021-306029 | 30" D x 60" L x 29" H | 3,325 | 3,033 | 3,609 | 71 lbs. |
| | 9021-307229 | 30" D x 72" L x 29" H | 3,727 | 3,391 | 4,082 | 77 lbs. |
|  <p>Fixed Top, Glides</p> | 9022-246029 | 24" D x 60" L x 29" H | 3,008 | 2,759 | 3,220 | 66 lbs. |
| | 9022-247229 | 24" D x 72" L x 29" H | 3,380 | 3,097 | 3,650 | 70 lbs. |
| | 9022-306029 | 30" D x 60" L x 29" H | 3,325 | 3,033 | 3,609 | 71 lbs. |
| | 9022-307229 | 30" D x 72" L x 29" H | 3,727 | 3,391 | 4,082 | 77 lbs. |

OPTIONS

| | | |
|-------------------------|-------------------------------------|-------|
| -PFM02 | Premium Metal Finish | \$101 |
| -PFW06 | Premium Wood Finish | \$311 |
| GC11 (order separately) | Ganging Connector (per table joint) | \$70 |
| MP38 (order separately) | Modesty Panel | \$304 |

Encore will determine best shipping method, whether blanket-wrapped or cartoned, based on unit quantity and destination. If cartoning is required, a 10% upcharge will be added to each product. Please contact client services for additional information.

CROMO MULTIPURPOSE TABLES | Designed by CLAUDIO BELLINI Studio

ORDERING REQUIREMENTS:

- Power unit model number should follow applicable table model number.

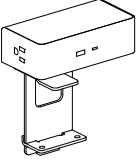
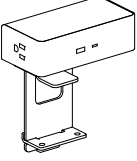

Note: No hardwire option available for this series.

| MODEL | DESCRIPTION | LIST |
|--|---|------|
| SPM-72  | Surface Power Module 1 Dimensions: 5" W x 3.5" D x 1.75" H White finish Unit features two simplex outlets, one USB-A and one USB-C charging port 72" electrical cord UL listed | 416 |
| SPM-120  | Surface Power Module 2 Dimensions: 5" W x 3.5" D x 1.75" H White finish Unit features two simplex outlets, one USB-A and one USB-C charging port 120" electrical cord UL listed | 416 |

Encore will determine best shipping method, whether blanket-wrapped or cartoned, based on unit quantity and destination. If cartoning is required, a 10% upcharge will be added to each product. Please contact client services for additional information.

CROMO MULTIPURPOSE TABLES | Designed by CLAUDIO BELLINI Studio

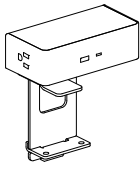
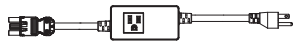
- Daisy chain units are required when more than one electrical unit is specified on one top.
- To determine jumper cable length, measure length from edge of electrical unit to end of table.

| MODEL | DESCRIPTION | LIST | | | | | | | | | | | | |
|--|---|-------|--------|------|----------|-----|-----|----------|-----|-----|----------|-----|-----|-----------|
| SPM-DC  | Surface Power Module Daisy Chain <ul style="list-style-type: none"> ■ Dimensions: 5" W x 3.5" D x 1.75" H ■ White finish ■ Unit features two simplex outlets, one USB-A and one USB-C charging port ■ Includes splitter for connection with starter cable and jumper cables ■ UL listed | 512 | | | | | | | | | | | | |
| ST-DC  | Starter Cable, 72" Long <ul style="list-style-type: none"> ■ Corded plug infeed ■ Connects from power source in wall or floor to first Surface Power Module ■ Includes convenience outlet | 199 | | | | | | | | | | | | |
| JC-CD ()  | Jumper Cables <ul style="list-style-type: none"> ■ Typically used to connect two (2) units together. <table border="1" data-bbox="532 1213 917 1507"> <thead> <tr> <th>MODEL</th> <th>LENGTH</th> <th>LIST</th> </tr> </thead> <tbody> <tr> <td>DC-CD-48</td> <td>48"</td> <td>121</td> </tr> <tr> <td>DC-CD-60</td> <td>60"</td> <td>129</td> </tr> <tr> <td>DC-CD-72</td> <td>72"</td> <td>136</td> </tr> </tbody> </table> | MODEL | LENGTH | LIST | DC-CD-48 | 48" | 121 | DC-CD-60 | 60" | 129 | DC-CD-72 | 72" | 136 | see table |
| MODEL | LENGTH | LIST | | | | | | | | | | | | |
| DC-CD-48 | 48" | 121 | | | | | | | | | | | | |
| DC-CD-60 | 60" | 129 | | | | | | | | | | | | |
| DC-CD-72 | 72" | 136 | | | | | | | | | | | | |

All shipments for this series will be cartoned as standard. If blanket-wrapped shipping is required, please contact client services for additional information.

ESPO | Designed by Henner Jahns of Gecco Vision



SPECIFICATIONS:

- Adjustable t-arm and signature polished aluminum cantilever arm models.
- Polished aluminum cantilever arm features black polyurethane arm cap.
- Adjustable t-arm features 3" arm height adjustment.
- Weight-activated synchro-tilt and swivel-tilt mechanism options.
- Fixed back height.
- Black nylon base as standard.
- Polished aluminum base also available. Please specify (-ABO2) after model number and refer to listed pricing.
- 300 lb. weight capacity.
- All dimensions are nominal.
- Refer to terms and conditions for general information regarding fabrics, finishes, warranty, freight, complete condition of sales and more.



All shipments for this series will be cartoned as standard. If blanket-wrapped shipping is required, please contact client services for additional information.

ESPO | Designed by Henner Jahns of Gecco Vision

Weight-Activated Synchro-Tilt Mechanism

ORDERING REQUIREMENTS:

- Model number
- Base finish
- Upholstery selection
- Options, as applicable

| MODEL | PRODUCT SPECIFICATIONS | BASE FINISH | FABRIC GRADES | | | | | | | | LEATHER | | | |
|---|--|----------------------------------|---------------|-------|-------|-------|-------|-------|----------|-------|---------|-------|-------|-------|
| | | | COM | A | 1 | 2 | 3 | 4 | COL 5 | 6 | 7 | 8 | L1 | L2 |
| 8413  | Adjustable T-Arms 25.5" W x 23.75" D x 38.75" - 42.75" H Seat: 21" W x 18.75" D Seat Ht: 16" - 20" Back: 21" W x 24" H COM: 1.75 yds. COL: 35 sq. ft. 40 lbs. | Black Nylon | 1,687 | 1,806 | 1,869 | 1,908 | 1,969 | 2,036 | 2,095 | 2,156 | 2,218 | 2,281 | 2,569 | 2,779 |
| | | Polished Aluminum (-AB02) | 1,874 | 1,993 | 2,056 | 2,095 | 2,156 | 2,223 | 2,282 | 2,343 | 2,405 | 2,468 | 2,756 | 2,966 |
| 8414  | Cantilever Arms 27" W x 23.75" D x 38.75" - 42.75" H Seat: 21" W x 18.75" D Seat Ht: 16" - 20" Back: 21" W x 24" H COM: 1.75 yds. COL: 35 sq. ft. 40 lbs. | Black Nylon | 1,809 | 1,928 | 1,991 | 2,030 | 2,091 | 2,158 | 2,217 | 2,278 | 2,340 | 2,403 | 2,691 | 2,901 |
| | | Polished Aluminum (-AB02) | 1,996 | 2,115 | 2,178 | 2,217 | 2,278 | 2,345 | 2,404 | 2,465 | 2,527 | 2,590 | 2,878 | 3,088 |

OPTIONS

- STC02 Soft Tread Casters \$33
- STLC02 Soft Tread Self-Locking Casters \$63

 = Available on quick-ship program.



All shipments for this series will be cartoned as standard. If blanket-wrapped shipping is required, please contact client services for additional information.

ESPO | Designed by Henner Jahns of Gecco Vision

Swivel-Tilt with Tilt-Lock Mechanism

ORDERING REQUIREMENTS:

- Model number
- Base finish
- Upholstery selection
- Options, as applicable

| MODEL | PRODUCT SPECIFICATIONS | BASE FINISH | FABRIC GRADES | | | | | | | | LEATHER | | | |
|---|--|---------------------------|---------------|-------|-------|-------|-------|-------|----------|-------|---------|-------|-------|-------|
| | | | COM | A | 1 | 2 | 3 | 4 | COL 5 | 6 | 7 | 8 | L1 | L2 |
| 8453  | Adjustable T-Arms 25.5" W x 23.75" D x 38.75" - 42.75" H Seat: 21" W x 18.75" D Seat Ht: 16" - 20" Back: 21" W x 24" H COM: 1.75 yds. COL: 35 sq. ft. 40 lbs. | Black Nylon | 1,680 | 1,799 | 1,862 | 1,901 | 1,962 | 2,029 | 2,088 | 2,149 | 2,211 | 2,274 | 2,562 | 2,772 |
| | | Polished Aluminum (-AB02) | 1,867 | 1,986 | 2,049 | 2,088 | 2,149 | 2,216 | 2,275 | 2,336 | 2,398 | 2,461 | 2,749 | 2,959 |
| 8454  | Cantilever Arms 27" W x 23.75" D x 38.75" - 42.75" H Seat: 21" W x 18.75" D Seat Ht: 16" - 20" Back: 21" W x 24" H COM: 1.75 yds. COL: 35 sq. ft. 40 lbs. | Black Nylon | 1,802 | 1,921 | 1,984 | 2,023 | 2,084 | 2,151 | 2,210 | 2,271 | 2,333 | 2,396 | 2,684 | 2,894 |
| | | Polished Aluminum (-AB02) | 1,989 | 2,108 | 2,171 | 2,210 | 2,271 | 2,338 | 2,397 | 2,458 | 2,520 | 2,583 | 2,871 | 3,081 |

OPTIONS

- STC02 Soft Tread Casters \$33
- STLC02 Soft Tread Self-Locking Casters \$63

 = Available on quick-ship program.

All shipments for this series will be blanket-wrapped as standard. For customers located in Territory 1 who require cartoning, a 5% upcharge will be added to each product. Please contact client services for additional information.

FACTION EXECUTIVE + TASK | Designed by 5d Studio



SPECIFICATIONS:

- Executive and task models.
- Executive models available with polished aluminum cantilever arms or loop arms.
- Task models offered with adjustable t-arms that feature 3" travel.
- Weight-activated and synchro-tilt mechanism options.
- Fixed back height.
- Black nylon base as standard.
- Polished aluminum base also available. Please specify (-ABO2) after model number and refer to listed pricing.
- 300 lb. weight capacity.
- All dimensions are nominal.
- Refer to terms and conditions for general information regarding fabrics, finishes, warranty, freight, complete condition of sales and more.



All shipments for this series will be blanket-wrapped as standard. For customers located in Territory 1 who require cartoning, a 5% upcharge will be added to each product. Please contact client services for additional information.

FACTION EXECUTIVE | Designed by 5d Studio

Weight-Activated Synchro-Tilt Mechanism

ORDERING REQUIREMENTS:

- Model number
- Base finish
- Upholstery selection
- Options, as applicable

| MODEL | PRODUCT SPECIFICATIONS | BASE FINISH | FABRIC GRADES | | | | | | | | LEATHER | | | |
|---|---|----------------------------------|---------------|-------|-------|-------|-------|-------|----------|-------|---------|-------|-------|-------|
| | | | COM | A | 1 | 2 | 3 | 4 | COL 5 | 6 | 7 | 8 | L1 | L2 |
| 1812-M  | Mid-Back, Cantilever Arms 23.5" W x 23" D x 38.5" - 42.5" H Seat: 19" W x 18" D Seat Ht: 17.5" - 21.5" Back : 19" W x 21" H COM: 1.75 yds. COL: 35 sq. ft. 45 lbs. | Black Nylon | 1,907 | 2,026 | 2,089 | 2,128 | 2,189 | 2,256 | 2,315 | 2,376 | 2,438 | 2,501 | 2,789 | 2,999 |
| | | Polished Aluminum (-AB02) | 2,094 | 2,213 | 2,276 | 2,315 | 2,376 | 2,443 | 2,502 | 2,563 | 2,625 | 2,688 | 2,976 | 3,186 |
| 1814-M  | Mid-Back, Loop Arms 23" W x 23" D x 38.5" - 42.5" H Seat: 19" W x 18" D Seat Ht: 17.5" - 21.5" Back : 19" W x 21" H COM: 1.75 yds. COL: 35 sq. ft. 46 lbs. | Black Nylon | 1,955 | 2,074 | 2,137 | 2,176 | 2,237 | 2,304 | 2,363 | 2,424 | 2,486 | 2,549 | 2,837 | 3,047 |
| | | Polished Aluminum (-AB02) | 2,142 | 2,261 | 2,324 | 2,363 | 2,424 | 2,491 | 2,550 | 2,611 | 2,673 | 2,736 | 3,024 | 3,234 |

OPTIONS

| | | |
|---------|---------------------------------|------|
| -STC02 | Soft Tread Casters | \$33 |
| -STLC02 | Soft Tread Self-Locking Casters | \$63 |



All shipments for this series will be blanket-wrapped as standard. For customers located in Territory 1 who require cartoning, a 5% upcharge will be added to each product. Please contact client services for additional information.

FACTION EXECUTIVE | Designed by 5d Studio

Weight-Activated Synchro-Tilt Mechanism

ORDERING REQUIREMENTS:

- Model number
- Base finish
- Upholstery selection
- Options, as applicable

| MODEL | PRODUCT SPECIFICATIONS | BASE FINISH | FABRIC GRADES | | | | | | | | LEATHER | | | |
|---|---|---------------------------|---------------|-------|-------|-------|-------|-------|----------|-------|---------|-------|-------|-------|
| | | | COM | A | 1 | 2 | 3 | 4 | COL 5 | 6 | 7 | 8 | L1 | L2 |
| 1812-H  | High Back, Cantilever Arms 23.5" W x 23" D x 45.5" - 49.5" H Seat: 19" W x 18" D Seat Ht: 17.5" - 21.5" Back : 19" W x 28.5" H COM: 2 yds. COL: 40 sq. ft. 48 lbs. | Black Nylon | 1,987 | 2,123 | 2,195 | 2,239 | 2,309 | 2,385 | 2,453 | 2,523 | 2,593 | 2,665 | 2,995 | 3,235 |
| | | Polished Aluminum (-AB02) | 2,174 | 2,310 | 2,382 | 2,426 | 2,496 | 2,572 | 2,640 | 2,710 | 2,780 | 2,852 | 3,182 | 3,422 |
| 1814-H  | High Back, Loop Arms 23" W x 23" D x 45.5" - 49.5" H Seat: 19" W x 18" D Seat Ht: 17.5" - 21.5" Back : 19" W x 28.5" H COM: 2 yds. COL: 40 sq. ft. 49 lbs. | Black Nylon | 2,033 | 2,169 | 2,241 | 2,285 | 2,355 | 2,431 | 2,499 | 2,569 | 2,639 | 2,711 | 3,041 | 3,281 |
| | | Polished Aluminum (-AB02) | 2,220 | 2,356 | 2,428 | 2,472 | 2,542 | 2,618 | 2,686 | 2,756 | 2,826 | 2,898 | 3,228 | 3,468 |

OPTIONS

| | | |
|---------|---------------------------------|------|
| -STC02 | Soft Tread Casters | \$33 |
| -STLC02 | Soft Tread Self-Locking Casters | \$63 |



All shipments for this series will be blanket-wrapped as standard. For customers located in Territory 1 who require cartoning, a 5% upcharge will be added to each product. Please contact client services for additional information.

FACTION EXECUTIVE | Designed by 5d Studio

Synchro-Tilt Mechanism

ORDERING REQUIREMENTS:

- Model number
- Base finish
- Upholstery selection
- Options, as applicable

| MODEL | PRODUCT SPECIFICATIONS | BASE FINISH | FABRIC GRADES | | | | | | | | LEATHER | | | |
|---|--|---------------------------|---------------|-------|-------|-------|-------|-------|----------|-------|---------|-------|-------|-------|
| | | | COM | A | 1 | 2 | 3 | 4 | COL 5 | 6 | 7 | 8 | L1 | L2 |
| 1892-M  | Mid-Back, Cantilever Arms 23.5" W x 23" D x 38.5" - 42.5" H Seat: 19" W x 18" D Seat Ht: 17.5" - 21.5" Back: 19" W x 21" H COM: 1.75 yds. COL: 35 sq. ft. 45 lbs. | Black Nylon | 1,726 | 1,845 | 1,908 | 1,947 | 2,008 | 2,075 | 2,134 | 2,195 | 2,257 | 2,320 | 2,608 | 2,818 |
| | | Polished Aluminum (-AB02) | 1,913 | 2,032 | 2,095 | 2,134 | 2,195 | 2,262 | 2,321 | 2,382 | 2,444 | 2,507 | 2,795 | 3,005 |
| 1894-M  | Mid-Back, Loop Arms 23" W x 23" D x 38.5" - 42.5" H Seat: 19" W x 18" D Seat Ht: 17.5" - 21.5" Back: 19" W x 21" H COM: 1.75 yds. COL: 35 sq. ft. 46 lbs. | Black Nylon | 1,948 | 2,067 | 2,130 | 2,169 | 2,230 | 2,297 | 2,356 | 2,417 | 2,479 | 2,542 | 2,830 | 3,040 |
| | | Polished Aluminum (-AB02) | 2,135 | 2,254 | 2,317 | 2,356 | 2,417 | 2,484 | 2,543 | 2,604 | 2,666 | 2,729 | 3,017 | 3,227 |

OPTIONS

| | | |
|---------|---------------------------------|-------|
| -SS01 | Seat Slider | \$102 |
| -STC02 | Soft Tread Casters | \$33 |
| -STLC02 | Soft Tread Self-Locking Casters | \$63 |



All shipments for this series will be blanket-wrapped as standard. For customers located in Territory 1 who require cartoning, a 5% upcharge will be added to each product. Please contact client services for additional information.

FACTION EXECUTIVE | Designed by 5d Studio

Synchro-Tilt Mechanism

ORDERING REQUIREMENTS:

- Model number
- Base finish
- Upholstery selection
- Options, as applicable

| MODEL | PRODUCT SPECIFICATIONS | BASE FINISH | FABRIC GRADES | | | | | | | | LEATHER | | | |
|---|--|---------------------------|---------------|-------|-------|-------|-------|-------|----------|-------|---------|-------|-------|-------|
| | | | COM | A | 1 | 2 | 3 | 4 | COL 5 | 6 | 7 | 8 | L1 | L2 |
| 1892-H  | High Back, Cantilever Arms 23.5" W x 23" D x 45.5" - 49.5" H Seat: 19" W x 18" D Seat Ht: 17.5" - 21.5" Back: 19" W x 28.5" H COM: 2 yds. COL: 40 sq. ft. 48 lbs. | Black Nylon | 1,841 | 1,977 | 2,049 | 2,093 | 2,163 | 2,239 | 2,307 | 2,377 | 2,447 | 2,519 | 2,849 | 3,089 |
| | | Polished Aluminum (-AB02) | 2,028 | 2,164 | 2,236 | 2,280 | 2,350 | 2,426 | 2,494 | 2,564 | 2,634 | 2,706 | 3,036 | 3,276 |
| 1894-H  | High Back, Loop Arms 23" W x 23" D x 45.5" - 49.5" H Seat: 19" W x 18" D Seat Ht: 17.5" - 21.5" Back: 19" W x 28.5" H COM: 2 yds. COL: 40 sq. ft. 49 lbs. | Black Nylon | 1,941 | 2,077 | 2,149 | 2,193 | 2,263 | 2,339 | 2,407 | 2,477 | 2,547 | 2,619 | 2,949 | 3,189 |
| | | Polished Aluminum (-AB02) | 2,128 | 2,264 | 2,336 | 2,380 | 2,450 | 2,526 | 2,594 | 2,664 | 2,734 | 2,806 | 3,136 | 3,376 |

OPTIONS

| | | |
|---------|---------------------------------|-------|
| -SS01 | Seat Slider | \$102 |
| -STC02 | Soft Tread Casters | \$33 |
| -STLC02 | Soft Tread Self-Locking Casters | \$63 |

All shipments for this series will be blanket-wrapped as standard. For customers located in Territory 1 who require cartoning, a 5% upcharge will be added to each product. Please contact client services for additional information.

FACTION TASK | Designed by 5d Studio

Synchro-Tilt Mechanism

ORDERING REQUIREMENTS:

- Model number
- Base finish
- Upholstery selection
- Options, as applicable

| MODEL | PRODUCT SPECIFICATIONS | BASE FINISH | FABRIC GRADES | | | | | | | | LEATHER | | | |
|--|--|----------------------------------|---------------|-------|-------|-------|-------|-------|----------|-------|---------|-------|-------|-------|
| | | | COM | A | 1 | 2 | 3 | 4 | COL 5 | 6 | 7 | 8 | L1 | L2 |
| 1893  | Adjustable T-Arms 27.75" W x 23" D x 38.5" - 42.5" H Seat: 19.5" W x 18" D Seat Ht: 17.5" - 21.5" Back: 19.5" W x 21"H COM: 1.75 yds. COL: 35 sq. ft. 40 lbs. | Black Nylon | 1,658 | 1,777 | 1,840 | 1,879 | 1,940 | 2,007 | 2,066 | 2,127 | 2,189 | 2,252 | 2,540 | 2,750 |
| | | Polished Aluminum (-AB02) | 1,845 | 1,964 | 2,027 | 2,066 | 2,127 | 2,194 | 2,253 | 2,314 | 2,376 | 2,439 | 2,727 | 2,937 |

OPTIONS

| | | |
|---------|---------------------------------|-------|
| -SS01 | Seat Slider | \$102 |
| -CT01 | Chrome Trim Arm Detail | \$67 |
| -STC02 | Soft Tread Casters | \$33 |
| -STLC02 | Soft Tread Self-Locking Casters | \$63 |

FACTION GUEST + NESTING | Designed by 5d Studio



SPECIFICATIONS:

- Fully upholstered and poly-back models.
- Polypropylene back available in four colors.
- Tubular steel frame.
- Guest models available with three arm options: armless, metal cantilever arms or polypropylene loop arms.
- Nesting models feature flip-up seat and are offered armless or with metal cantilever arms.
- Please see below for back and arm finish options.
- Metal arm finish will match frame finish unless specified otherwise.
- For custom finish colors, please contact client services for pricing.
- Guest models with glides feature wall-saver leg design.
- If cartoning is required, chairs are packaged in units of three (3). A \$20 List carton break charge will be applied for orders with only one or two chairs.
- Chairs stack up to 4-high standing or 5 with dolly. Please note that dolly is not recommended for caster models.
- 300 lb. weight capacity.
- All dimensions are nominal.
- Refer to terms and conditions for general information regarding fabrics, finishes, warranty, freight, complete condition of sales and more.

STANDARD METAL ARM/FRAME FINISH COLORS:

- 0405 Charcoal Grey
- 0535 Metallic Silver
- 0199 Chrome (frame only)
- 0299 Polished Aluminum (arm only)
- 0630 Satin Black

PREMIUM METAL ARM/FRAME FINISH COLORS:

- 0605 Matte Black
- 0705 Matte Cotton
- 0788 Glossy Cotton
- 0805 Oasis
- 0905 Mint
- 1005 Mercury
- 1105 Canary
- 1205 Stone
- 1305 Sage
- 1405 Ice Blue
- 1505 Clay

POLYPROPYLENE BACK/ARM COLORS:



- 136 Studio White
- 137 Simply Black
- 138 Soft Grey
- 139 Charcoal

All shipments for this series will be blanket-wrapped as standard. For customers located in Territory 1 who require cartoning, a 5% upcharge will be added to each product. Please contact client services for additional information.

FACTION GUEST | Designed by 5d Studio

ORDERING REQUIREMENTS:

- Model number
- Arm finish, as applicable
- Frame finish
- Upholstery selection
- Options, as applicable

| MODEL | PRODUCT SPECIFICATIONS | FABRIC GRADES | | | | | | | | LEATHER | | | |
|---|---|---------------|-------|-------|-------|-------|-------|----------|-------|---------|-------|-------|-------|
| | | COM | A | 1 | 2 | 3 | 4 | COL 5 | 6 | 7 | 8 | L1 | L2 |
| 18111-U  | Guest Chair, Upholstered Back, Armless, Glides 20.75" W x 22" D x 33" H Seat: 18" W x 19" D Seat Ht: 18" COM: 1.25 yds. COL: 25 sq. ft. 23 lbs. | 921 | 1,006 | 1,051 | 1,079 | 1,123 | 1,170 | 1,213 | 1,256 | 1,300 | 1,345 | 1,551 | 1,701 |
| 18121-U  | Guest Chair, Upholstered Back, Metal Cantilever Arms, Glides 24.75" W x 22" D x 33" H Seat: 18" W x 19" D Seat Ht: 18" Arm Ht: 26.75" COM: 1.25 yds. COL: 25 sq. ft. 26 lbs. | 1,077 | 1,162 | 1,207 | 1,235 | 1,279 | 1,326 | 1,369 | 1,412 | 1,456 | 1,501 | 1,707 | 1,857 |
| 18141-U  | Guest Chair, Upholstered Back, Poly Loop Arms, Glides 24.75" W x 22" D x 33" H Seat: 18" W x 19" D Seat Ht: 18" Arm Ht: 26.75" COM: 1.25 yds. COL: 25 sq. ft. 27 lbs. | 961 | 1,046 | 1,091 | 1,119 | 1,163 | 1,210 | 1,253 | 1,296 | 1,340 | 1,385 | 1,591 | 1,741 |

OPTIONS



- PFM02 Premium Metal Finish \$101
- VCT04 VCT Tile Glides \$28

All shipments for this series will be blanket-wrapped as standard. For customers located in Territory 1 who require cartoning, a 5% upcharge will be added to each product. Please contact client services for additional information.

FACTION GUEST | Designed by 5d Studio

ORDERING REQUIREMENTS:

- Model number
- Arm finish, as applicable
- Frame finish
- Upholstery selection
- Options, as applicable

| MODEL | PRODUCT SPECIFICATIONS | FABRIC GRADES | | | | | | | | LEATHER | | | |
|---|---|---------------|-------|-------|-------|-------|-------|----------|-------|---------|-------|-------|-------|
| | | COM | A | 1 | 2 | 3 | 4 | COL 5 | 6 | 7 | 8 | L1 | L2 |
| 18115-U  | Guest Chair, Upholstered Back, Armless, Casters 20.75" W x 22" D x 33" H Seat: 18" W x 19" D Seat Ht: 18" COM: 1.25 yds. COL: 25 sq. ft. 23 lbs. | 914 | 999 | 1,044 | 1,072 | 1,116 | 1,163 | 1,206 | 1,249 | 1,293 | 1,338 | 1,544 | 1,694 |
| 18125-U  | Guest Chair, Upholstered Back, Metal Cantilever Arms, Casters 24.75" W x 22" D x 33" H Seat: 18" W x 19" D Seat Ht: 18" Arm Ht: 26.75" COM: 1.25 yds. COL: 25 sq. ft. 26 lbs. | 1,070 | 1,155 | 1,200 | 1,228 | 1,272 | 1,319 | 1,362 | 1,405 | 1,449 | 1,494 | 1,700 | 1,850 |
| 18145-U  | Guest Chair, Upholstered Back, Poly Loop Arms, Casters 24.75" W x 22" D x 33" H Seat: 18" W x 19" D Seat Ht: 18" Arm Ht: 26.75" COM: 1.25 yds. COL: 25 sq. ft. 28 lbs. | 980 | 1,065 | 1,110 | 1,138 | 1,182 | 1,229 | 1,272 | 1,315 | 1,359 | 1,404 | 1,610 | 1,760 |

OPTIONS



- PFM02 Premium Metal Finish \$101
- STC02 Soft Tread Casters \$33

All shipments for this series will be blanket-wrapped as standard. For customers located in Territory 1 who require cartoning, a 5% upcharge will be added to each product. Please contact client services for additional information.

FACTION GUEST | Designed by 5d Studio

ORDERING REQUIREMENTS:

- Model number
- Poly back color
- Arm finish, as applicable
- Frame finish
- Upholstery selection
- Options, as applicable

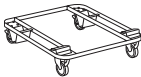
| MODEL | PRODUCT SPECIFICATIONS | FABRIC GRADES | | | | | | | | | | LEATHER | |
|---------|--|---------------|-------|-------|-------|-------|-------|----------|-------|-------|-------|---------|-------|
| | | COM | A | 1 | 2 | 3 | 4 | COL 5 | 6 | 7 | 8 | L1 | L2 |
| 18111-P |  <p>Guest Chair, Poly Back Armless, Glides 20.75" W x 22" D x 33" H Seat: 18" W x 19" D Seat Ht: 18" COM: .75 yd. COL: 15 sq. ft. 22 lbs.</p> | 821 | 872 | 899 | 916 | 942 | 971 | 996 | 1,022 | 1,049 | 1,076 | 1,199 | 1,289 |
| 18121-P |  <p>Guest Chair, Poly Back Metal Cantilever Arms, Glides 24.75" W x 22" D x 33" H Seat: 18" W x 19" D Seat Ht: 18" Arm Ht: 26.75" COM: .75 yd. COL: 15 sq. ft. 25 lbs.</p> | 977 | 1,028 | 1,055 | 1,072 | 1,098 | 1,127 | 1,152 | 1,178 | 1,205 | 1,232 | 1,355 | 1,445 |
| 18141-P |  <p>Guest Chair, Poly Back Poly Loop Arms, Glides 24.75" W x 22" D x 33" H Seat: 18" W x 19" D Seat Ht: 18" Arm Ht: 26.75" COM: .75 yd. COL: 15 sq. ft. 27 lbs.</p> | 857 | 908 | 935 | 952 | 978 | 1,007 | 1,032 | 1,058 | 1,085 | 1,112 | 1,235 | 1,325 |
| 1800 |  <p>Dolly (Black Finish Only) 24" W x 30" D x 6" H 37 lbs.</p> | 444 | | | | | | | | | | | |

OPTIONS

- PFM02 Premium Metal Finish \$101
- VCT04 VCT Tile Glides \$28



 = Available on quick-ship program (0535 Metallic Silver and 0199 Chrome frame finishes, model 18121-P 0299 Polished Aluminum arms only).

All shipments for this series will be blanket-wrapped as standard. For customers located in Territory 1 who require cartoning, a 5% upcharge will be added to each product. Please contact client services for additional information.

FACTION GUEST | Designed by 5d Studio

ORDERING REQUIREMENTS:

- Model number
- Poly back color
- Arm finish, as applicable
- Frame finish
- Upholstery selection
- Options, as applicable

| MODEL | PRODUCT SPECIFICATIONS | FABRIC GRADES | | | | | | | | LEATHER | | | |
|---------|---|---------------|-------|-------|-------|-------|-------|----------|-------|---------|-------|-------|-------|
| | | COM | A | 1 | 2 | 3 | 4 | COL 5 | 6 | 7 | 8 | L1 | L2 |
| 18115-P |  <p>Guest Chair, Poly Back Armless, Casters 20.75" W x 22" D x 33" H Seat: 18" W x 19" D Seat Ht: 18" COM: .75 yd. COL: 15 sq. ft. 22 lbs.</p> | 814 | 865 | 892 | 909 | 935 | 964 | 989 | 1,015 | 1,042 | 1,069 | 1,192 | 1,282 |
| 18125-P |  <p>Guest Chair, Poly Back Metal Cantilever Arms, Casters 24.75" W x 22" D x 33" H Seat: 18" W x 19" D Seat Ht: 18" Arm Ht: 26.75" COM: .75 yd. COL: 15 sq. ft. 25 lbs.</p> | 970 | 1,021 | 1,048 | 1,065 | 1,091 | 1,120 | 1,145 | 1,171 | 1,198 | 1,225 | 1,348 | 1,438 |
| 18145-P |  <p>Guest Chair, Poly Back Poly Loop Arms, Casters 24.75" W x 22" D x 33" H Seat: 18" W x 19" D Seat Ht: 18" Arm Ht: 26.75" COM: .75 yd. COL: 15 sq. ft. 27 lbs.</p> | 880 | 931 | 958 | 975 | 1,001 | 1,030 | 1,055 | 1,081 | 1,108 | 1,135 | 1,258 | 1,348 |

OPTIONS

- PFM02 Premium Metal Finish \$101
- STC02 Soft Tread Casters \$33



 = Available on quick-ship program (0535 Metallic Silver and 0199 Chrome frame finishes, model 18125-P 0299 Polished Aluminum arms only).

All shipments for this series will be blanket-wrapped as standard. For customers located in Territory 1 who require cartoning, a 5% upcharge will be added to each product. Please contact client services for additional information.

FACTION NESTING | Designed by 5d Studio

ORDERING REQUIREMENTS:

- Model number
- Arm finish, as applicable
- Frame finish
- Upholstery selection
- Options, as applicable

| MODEL | PRODUCT SPECIFICATIONS | FABRIC GRADES | | | | | | | | LEATHER | | | |
|--|---|---------------|-------|-------|-------|-------|-------|----------|-------|---------|-------|-------|-------|
| | | COM | A | 1 | 2 | 3 | 4 | COL 5 | 6 | 7 | 8 | L1 | L2 |
| 18715-U  | Nesting Chair, Fully Upholstered Armless, Casters 20.75" W x 22" D x 33" H Seat: 18" W x 19" D Seat Ht: 18" COM: 1.25 yds. COL: 25 sq. ft. 18 lbs. | 965 | 1,050 | 1,095 | 1,123 | 1,167 | 1,214 | 1,257 | 1,300 | 1,344 | 1,389 | 1,595 | 1,745 |
| 18725-U  | Nesting Chair, Fully Upholstered Metal Cantilever Arms, Casters 24.75" W x 22" D x 33" H Seat: 18" W x 19" D Seat Ht: 18" Arm Ht: 26.75" COM: 1.25 yds. COL: 25 sq. ft. 21 lbs. | 1,121 | 1,206 | 1,251 | 1,279 | 1,323 | 1,370 | 1,413 | 1,456 | 1,500 | 1,545 | 1,751 | 1,901 |

OPTIONS NESTING DIMENSIONS

- PFM02 Premium Metal Finish \$101
- STC02 Soft Tread Casters \$33

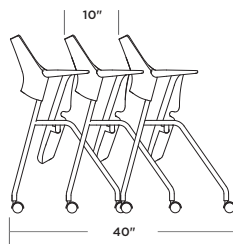



All shipments for this series will be blanket-wrapped as standard. For customers located in Territory 1 who require cartoning, a 5% upcharge will be added to each product. Please contact client services for additional information.

FACTION NESTING | Designed by 5d Studio

ORDERING REQUIREMENTS:

- Model number
- Poly back color
- Arm finish, as applicable
- Frame finish
- Upholstery selection
- Options, as applicable

| MODEL | PRODUCT SPECIFICATIONS | FABRIC GRADES | | | | | | | | LEATHER | | | |
|---------|--|---------------|-------|-------|-------|-------|-------|----------|-------|---------|-------|-------|-------|
| | | COM | A | 1 | 2 | 3 | 4 | COL 5 | 6 | 7 | 8 | L1 | L2 |
| 18715-P |  <p>Nesting Chair, Poly Back Armless, Casters 20.75" W x 22" D x 33" H Seat: 18" W x 19" D Seat Ht: 18" COM: .75 yd. COL: 15 sq. ft. 17 lbs.</p> | 863 | 914 | 941 | 958 | 984 | 1,013 | 1,038 | 1,064 | 1,091 | 1,118 | 1,241 | 1,331 |
| 18725-P |  <p>Nesting Chair, Poly Back Metal Cantilever Arms, Casters 24.75" W x 22" D x 33" H Seat: 18" W x 19" D Seat Ht: 18" Arm Ht: 26.75" COM: .75 yd. COL: 15 sq. ft. 20 lbs.</p> | 1,019 | 1,070 | 1,097 | 1,114 | 1,140 | 1,169 | 1,194 | 1,220 | 1,247 | 1,274 | 1,397 | 1,487 |

OPTIONS NESTING DIMENSIONS

- PFM02 Premium Metal Finish \$101
- STC02 Soft Tread Casters \$33

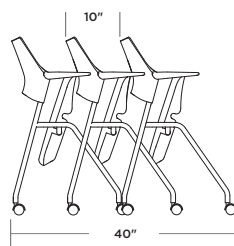

 = Available on quick-ship program (0535 Metallic Silver and 0199 Chrome frame finishes with 0299 Polished Aluminum arms only).

All shipments for this series will be cartoned as standard. If blanket-wrapped shipping is required, please contact client services for additional information.

FACTION SWIVEL | Designed by 5d Studio



SPECIFICATIONS:

- Fully upholstered and poly-back models.
- Polypropylene back available in four colors.
- Armless and metal cantilever arm models.
- Arms and frame available in standard and premium finishes. See below for options.
- Arm finish will match frame finish unless specified otherwise.
- For custom finish colors, please contact client services for pricing.
- For armless models, please specify frame finish.
- Two base options: black nylon and polished aluminum.
- Black nylon base option reduces seat height by 1".
- Fixed back height.
- Non-tilt, height adjustable swivel mechanism.
- 300 lb. weight capacity.
- Ships KD (knocked down).
- All dimensions are nominal.
- Refer to terms and conditions for general information regarding fabrics, finishes, warranty, freight, complete condition of sales and more.

STANDARD METAL ARM/FRAME FINISH COLORS:

- 0405 Charcoal Grey
- 0535 Metallic Silver
- 0199 Chrome (frame only)
- 0299 Polished Aluminum (arm only)
- 0630 Satin Black

PREMIUM METAL ARM/FRAME FINISH COLORS:

- 0605 Matte Black
- 0705 Matte Cotton
- 0788 Glossy Cotton
- 0805 Oasis
- 0905 Mint
- 1005 Mercury
- 1105 Canary
- 1205 Stone
- 1305 Sage
- 1405 Ice Blue
- 1505 Clay

POLYPROPYLENE BACK COLORS:



- 136 Studio White
- 137 Simply Black
- 138 Soft Grey
- 139 Charcoal

All shipments for this series will be cartoned as standard. If blanket-wrapped shipping is required, please contact client services for additional information.

FACTION SWIVEL | Designed by 5d Studio

ORDERING REQUIREMENTS:

- Model number
- Arm finish, as applicable
- Frame finish
- Base finish
- Upholstery selection
- Options, as applicable

| MODEL | PRODUCT SPECIFICATIONS | BASE FINISH | FABRIC GRADES | | | | | | | | LEATHER | | | |
|--|---|----------------------------------|---------------|-------|-------|-------|-------|-------|----------|-------|---------|-------|-------|-------|
| | | | COM | A | 1 | 2 | 3 | 4 | COL 5 | 6 | 7 | 8 | L1 | L2 |
| 18113-U  | Fully Upholstered, Armless 20.75" W x 25.25" D x 32.5" - 37" H Seat: 18" W x 19" D Seat Ht: 18" Back: 18" W x 15" H COM: 1.25 yds. COL: 25 sq. ft. 28 lbs. | Black Nylon | 1,100 | 1,185 | 1,230 | 1,258 | 1,302 | 1,349 | 1,392 | 1,435 | 1,479 | 1,524 | 1,730 | 1,880 |
| | | Polished Aluminum (-AB02) | 1,287 | 1,372 | 1,417 | 1,445 | 1,489 | 1,536 | 1,579 | 1,622 | 1,666 | 1,711 | 1,917 | 2,067 |
| 18123-U  | Fully Upholstered, Metal Cantilever Arms 24.75" W x 25.25" D x 32.5" - 37" H Seat: 18" W x 19" D Seat Ht: 18" Back: 18" W x 15" H COM: 1.25 yds. COL: 25 sq. ft. 31 lbs. | Black Nylon | 1,256 | 1,341 | 1,386 | 1,414 | 1,458 | 1,505 | 1,548 | 1,591 | 1,635 | 1,680 | 1,886 | 2,036 |
| | | Polished Aluminum (-AB02) | 1,443 | 1,528 | 1,573 | 1,601 | 1,645 | 1,692 | 1,735 | 1,778 | 1,822 | 1,867 | 2,073 | 2,223 |

OPTIONS



| | | |
|---------|---|-------|
| -PFM02 | Premium Metal Finish (arms/frame only) | \$101 |
| -STC02 | Soft Tread Casters | \$33 |
| -STLC02 | Soft Tread Self-Locking Casters | \$63 |
| -SK01 | Stool Kit | \$120 |

All shipments for this series will be cartoned as standard. If blanket-wrapped shipping is required, please contact client services for additional information.

FACTION SWIVEL | Designed by 5d Studio

ORDERING REQUIREMENTS:

- Model number
- Poly back color
- Arm finish, as applicable
- Frame finish
- Base finish
- Upholstery selection
- Options, as applicable

| MODEL | PRODUCT SPECIFICATIONS | BASE FINISH | FABRIC GRADES | | | | | | | | LEATHER | | | |
|---|---|----------------------------------|---------------|-------|-------|-------|-------|-------|----------|-------|---------|-------|-------|-------|
| | | | COM | A | 1 | 2 | 3 | 4 | COL 5 | 6 | 7 | 8 | L1 | L2 |
| 18113-P  | 🕒 Poly Back, Armless 20.75" W x 25.25" D x 32.5" - 37" H Seat: 18" W x 19" D Seat Ht: 18" Back: 18" W x 15" H COM: .75 yd. COL: 15 sq. ft. 27 lbs. | Black Nylon | 1,020 | 1,071 | 1,098 | 1,115 | 1,141 | 1,170 | 1,195 | 1,221 | 1,248 | 1,275 | 1,398 | 1,488 |
| | | Polished Aluminum (-AB02) | 1,207 | 1,258 | 1,285 | 1,302 | 1,328 | 1,357 | 1,382 | 1,408 | 1,435 | 1,462 | 1,585 | 1,675 |
| 18123-P  | 🕒 Poly Back, Metal Cantilever Arms 24.75" W x 25.25" D x 32.5" - 37" H Seat: 18" W x 19" D Seat Ht: 18" Back: 18" W x 15" H COM: .75 yd. COL: 15 sq. ft. 30 lbs. | Black Nylon | 1,176 | 1,227 | 1,254 | 1,271 | 1,297 | 1,326 | 1,351 | 1,377 | 1,404 | 1,431 | 1,554 | 1,644 |
| | | Polished Aluminum (-AB02) | 1,363 | 1,414 | 1,441 | 1,458 | 1,484 | 1,513 | 1,538 | 1,564 | 1,591 | 1,618 | 1,741 | 1,831 |

OPTIONS

| | | |
|---------|--|-------|
| -PFM02 | Premium Metal Finish (arms/frame only) | \$101 |
| -STC02 | Soft Tread Casters | \$33 |
| -STLC02 | Soft Tread Self-Locking Casters | \$63 |
| -SK01 | Stool Kit | \$120 |

 = Available on quick-ship program (O199 Chrome frame finish with O299 Polished Aluminum arms only).

All shipments for this series will be cartoned as standard. If blanket-wrapped shipping is required, please contact client services for additional information.

FACTION SWIVEL | Designed by 5d Studio

UPHOLSTERY COMBINATIONS:

- For upholstery combinations, refer to the pricing below.
- When combining two COM/COV/COL fabrics, or fabrics with the same grade, add \$120 List per unit.
- When combining three or more COM/COV/COL fabrics, or fabrics with the same grade, add \$150 List per unit.
- When combining different grades of fabric, price will be based on the highest grade specified.
- Two-tone upholstery examples and yardage requirements for the most common combinations are listed below. Additional combinations available; please contact client services for yardage requirements and pricing.
- Note: Yardage amounts are based on fabric which is plain (i.e. non-directional) and a full 54" wide.
- Appropriate upholstery code must be included.

| Code | FC1 |
|------------------------------|----------------------------------|
| <u>Model</u> | <u>COM Requirement</u> |
| All Fully Upholstered Models | Seat = .75 yd. Back = .75 yd. |

All shipments for this series will be blanket-wrapped as standard. For customers located in Territory 1 who require cartoning, a 5% upcharge will be added to each product. Please contact client services for additional information.

FLING® GUEST | Designed by 5d Studio



SPECIFICATIONS:

- 4-leg base available in standard and premium finishes. See below for options.
- For custom finish colors, please contact client services for pricing.
- 300 lb. weight capacity.
- All dimensions are nominal.
- Refer to terms and conditions for general information regarding fabrics, finishes, warranty, freight, complete condition of sales and more.

STANDARD METAL BASE FINISH COLORS:

- 0405 Charcoal Grey
- 0535 Metallic Silver
- 0199 Chrome
- 0630 Satin Black

PREMIUM METAL BASE FINISH COLORS:

- 0605 Matte Black
- 0705 Matte Cotton
- 0788 Glossy Cotton
- 0805 Oasis
- 0905 Mint
- 1005 Mercury
- 1105 Canary
- 1205 Stone
- 1305 Sage
- 1405 Ice Blue
- 1505 Clay

All shipments for this series will be blanket-wrapped as standard. For customers located in Territory 1 who require cartoning, a 5% upcharge will be added to each product. Please contact client services for additional information.

FLING® GUEST | Designed by 5d Studio

ORDERING REQUIREMENTS:

- Model number
- Base finish
- Upholstery selection
- Options, as applicable

| MODEL | PRODUCT SPECIFICATIONS | FABRIC GRADES | | | | | | | | LEATHER | | | |
|--|---|---------------|-------|-------|-------|-------|-------|----------|-------|---------|-------|-------|-------|
| | | COM | A | 1 | 2 | 3 | 4 | COL 5 | 6 | 7 | 8 | L1 | L2 |
| 2110-U  | Guest Chair, 4-Leg Base 23.75" W x 24" D x 30.25" H Seat: 19" W x 19" D Seat Ht: 17.5" COM: 2.75 yds. COL: 55 sq. ft. 20 lbs. | 1,359 | 1,546 | 1,645 | 1,706 | 1,802 | 1,907 | 2,000 | 2,096 | 2,193 | 2,292 | 2,745 | 3,075 |

OPTIONS

- | | | |
|--------|---------------------------|-------|
| -PFM02 | Premium Metal Base Finish | \$101 |
| -VCT04 | VCT Tile Glides | \$28 |

FLING® GUEST | Designed by 5d Studio

UPHOLSTERY COMBINATIONS:

- For upholstery combinations, refer to the pricing below.
- When combining two COM/COV/COL fabrics, or fabrics with the same grade, add \$120 List per unit.
- When combining three or more COM/COV/COL fabrics, or fabrics with the same grade, add \$150 List per unit.
- When combining different grades of fabric, price will be based on the highest grade specified.
- Two-tone upholstery examples and yardage requirements for the most common combinations are listed below. Additional combinations available; please contact client services for yardage requirements and pricing.
- Note: Yardage amounts are based on fabric which is plain (i.e. non-directional) and a full 54" wide.
- Appropriate upholstery code must be included.



Code **FG2**

Model COM Requirement

2110-U Inside/Outside Back = 1 yd.
Balance of Chair = 1.5 yds.



Code **FG3**

Model COM Requirement

2110-U Inside/Outside Back & Seat Cushion = 1.75 yds.
Balance of Chair = 2.25 yds.



Code **FG4**

Model COM Requirement

2110-U Seat Cushion Only = .75 yd.
Balance of Chair = 2.5 yds.

All shipments for this series will be blanket-wrapped as standard. For customers located in Territory 1 who require cartoning, a 5% upcharge will be added to each product. Please contact client services for additional information.

FLING® LOUNGE | Designed by 5d Studio



SPECIFICATIONS:

- 4-leg base available in standard and premium finishes. See below for options.
- For custom finish colors, please contact client services for pricing.
- 300 lb. weight capacity.
- All dimensions are nominal.
- Refer to terms and conditions for general information regarding fabrics, finishes, warranty, freight, complete condition of sales and more.

STANDARD METAL BASE FINISH COLORS:

- 0405 Charcoal Grey
- 0535 Metallic Silver
- 0199 Chrome
- 0630 Satin Black

PREMIUM METAL BASE FINISH COLORS:

- 0605 Matte Black
- 0705 Matte Cotton
- 0788 Glossy Cotton
- 0805 Oasis
- 0905 Mint
- 1005 Mercury
- 1105 Canary
- 1205 Stone
- 1305 Sage
- 1405 Ice Blue
- 1505 Clay

All shipments for this series will be blanket-wrapped as standard. For customers located in Territory 1 who require cartoning, a 5% upcharge will be added to each product. Please contact client services for additional information.

FLING® LOUNGE | Designed by 5d Studio

ORDERING REQUIREMENTS:

- Model number
- Base finish
- Upholstery selection
- Options, as applicable

| MODEL | PRODUCT SPECIFICATIONS | FABRIC GRADES | | | | | | | | LEATHER | | | |
|--|---|---------------|-------|-------|-------|-------|-------|----------|-------|---------|-------|-------|-------|
| | | COM | A | 1 | 2 | 3 | 4 | COL 5 | 6 | 7 | 8 | L1 | L2 |
| 2170-U  | Lounge Chair, 4-Leg Base 28.5" W x 27.75" D x 30" H Seat: 22" W x 20" D Seat Ht: 17" COM: 3.75 yds. COL: 75 sq. ft. 28 lbs. | 1,832 | 2,087 | 2,222 | 2,305 | 2,436 | 2,579 | 2,706 | 2,837 | 2,969 | 3,104 | 3,722 | 4,172 |

OPTIONS

| | | |
|--------|---------------------------|-------|
| -PFM02 | Premium Metal Base Finish | \$101 |
| -VCT04 | VCT Tile Glides | \$28 |

FLING® LOUNGE | Designed by 5d Studio

UPHOLSTERY COMBINATIONS:

- For upholstery combinations, refer to the pricing below.
- When combining two COM/COV/COL fabrics, or fabrics with the same grade, add \$120 List per unit.
- When combining three or more COM/COV/COL fabrics, or fabrics with the same grade, add \$150 List per unit.
- When combining different grades of fabric, price will be based on the highest grade specified.
- Two-tone upholstery examples and yardage requirements for the most common combinations are listed below. Additional combinations available; please contact client services for yardage requirements and pricing.
- Note: Yardage amounts are based on fabric which is plain (i.e. non-directional) and a full 54" wide.
- Appropriate upholstery code must be included.



Code FL2

Model COM Requirement

2170-U Inside/Outside Back = 1.25 yds.
Balance of Chair = 2 yds.



Code FL3

Model COM Requirement

2170-U Inside/Outside Back & Seat Cushion = 2.25 yds.
Balance of Chair = 3 yds.



Code FL4

Model COM Requirement

2170-U Seat Cushion Only = 1 yd.
Balance of Chair = 3.25 yds.

All shipments for this series will be blanket-wrapped as standard. For customers located in Territory 1 who require cartoning, a 5% upcharge will be added to each product. Please contact client services for additional information.

GOGO BENCHES | Designed by Qdesign



PRODUCT FEATURES:



- Single seat and two-seat models.
- Single seat models offered with casters or glides. Two-seat models available with glides only.
- Single seat feature 300 lb. weight capacity.
- Two-seat feature 600 lb. weight capacity.
- All dimensions are nominal.
- Refer to terms and conditions for general information regarding fabrics, finishes, warranty, freight, complete condition of sales and more.

All shipments for this series will be blanket-wrapped as standard. For customers located in Territory 1 who require cartoning, a 5% upcharge will be added to each product. Please contact client services for additional information.

GOGO BENCHES | Designed by Qdesign

ORDERING REQUIREMENTS:

- Model number
- Upholstery selection
- Options, as applicable

| MODEL | PRODUCT SPECIFICATIONS | FABRIC GRADES | | | | | | | | | | LEATHER | |
|--|---|---------------|-------|-------|-------|-------|-------|----------|-------|-------|-------|---------|-------|
| | | COM | A | 1 | 2 | 3 | 4 | COL 5 | 6 | 7 | 8 | L1 | L2 |
| 6750  | Single Seat Bench, Glides Overall: 24" W x 22.5" D x 16.75 H" COM: 2.25 yds. COL: 45 sq. ft. 20 lbs. | 1,150 | 1,303 | 1,384 | 1,434 | 1,513 | 1,598 | 1,675 | 1,753 | 1,832 | 1,913 | 2,284 | 2,554 |
| 6755  | Single Seat Bench, Casters Overall: 24" W x 22.5" D x 16.75 H" COM: 2.25 yds. COL: 45 sq. ft. 20 lbs. | 1,150 | 1,303 | 1,384 | 1,434 | 1,513 | 1,598 | 1,675 | 1,753 | 1,832 | 1,913 | 2,284 | 2,554 |
| 6760  | 2-Seat Bench, Glides Overall: 48" W x 22.5" D x 16.75 H" COM: 3 yds. COL: 60 sq. ft. 33 lbs. | 2,044 | 2,248 | 2,356 | 2,422 | 2,527 | 2,641 | 2,743 | 2,848 | 2,953 | 3,061 | 3,556 | 3,916 |

OPTIONS

-FG04 Felt Glides \$26

GOGO BENCHES | Designed by Qdesign

UPHOLSTERY COMBINATIONS:

- For upholstery combinations, refer to the pricing below.
- When combining two COM/COV/COL fabrics, or fabrics with the same grade, add \$120 List per unit.
- When combining three or more COM/COV/COL fabrics, or fabrics with the same grade, add \$150 List per unit.
- When combining different grades of fabric, price will be based on the highest grade specified.
- Two-tone upholstery examples and yardage requirements for the most common combinations are listed below. Additional combinations available; please contact client services for yardage requirements and pricing.
- Note: Yardage amounts are based on fabric which is plain (i.e. non-directional) and a full 54" wide.
- Appropriate upholstery code must be included.

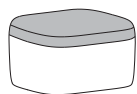

| Code | GG9 |
|--------------|------------------------------|
| <u>Model</u> | <u>COM Requirement</u> |
| 6750 | Seat Cushion = 1 yd. |
| 6755 | Balance of Bench = 1.25 yds. |

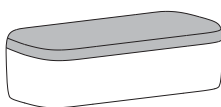

| Code | GG10 |
|--------------|------------------------------|
| <u>Model</u> | <u>COM Requirement</u> |
| 6760 | Seat Cushion = 1.25 yds. |
| | Balance of Bench = 1.75 yds. |

All shipments for this series will be blanket-wrapped as standard. For customers located in Territory 1 who require cartoning, a 5% upcharge will be added to each product. Please contact client services for additional information.

GOGO LOUNGE | Designed by Qdesign



PRODUCT FEATURES:

- Arm and armless lounge and love seat models.
- Lounge chairs offered with casters or glides. Love seats available with glides only.
- Caster/glide combination also offered to limit movement while seated, but still allow for easy maneuverability when not in use.
- Optional leather pull handle on lounge models (not available on love seats).
- Pull handle is offered in four standard leather color options. Please refer to listing below.
- Lounge chairs feature 300 lb. weight capacity.
- Love seats feature 600 lb. weight capacity.
- All dimensions are nominal.
- Refer to terms and conditions for general information regarding fabrics, finishes, warranty, freight, complete condition of sales and more.

STANDARD LEATHER PULL HANDLE COLORS:



Black



Bright White



Saddle



Stone Grey









All shipments for this series will be blanket-wrapped as standard. For customers located in Territory 1 who require cartoning, a 5% upcharge will be added to each product. Please contact client services for additional information.

GOGO LOUNGE | Designed by Qdesign

ORDERING REQUIREMENTS:

- Model number
- Upholstery selection
- Options, as applicable

Note: caster/glide combination limits movement while seated, but still allows for easy maneuverability when not in use.

| MODEL | PRODUCT SPECIFICATIONS | FABRIC GRADES | | | | | | | | | | LEATHER | |
|--|--|---------------|-------|-------|-------|-------|-------|----------|-------|-------|-------|---------|-------|
| | | COM | A | 1 | 2 | 3 | 4 | COL 5 | 6 | 7 | 8 | L1 | L2 |
| 6710  |  Lounge Chair, Armless, Glides 24" W x 27.25" D x 32" H Seat: 23.25" W x 18.25" D Seat Ht: 16.75" COM: 3 yds. COL: 60 sq. ft. 42 lbs. | 1,666 | 1,870 | 1,978 | 2,044 | 2,149 | 2,263 | 2,365 | 2,470 | 2,575 | 2,683 | 3,178 | 3,538 |
| 6715  |  Lounge Chair, Armless, Casters 24" W x 27.25" D x 32" H Seat: 23.25" W x 18.25" D Seat Ht: 16.75" COM: 3 yds. COL: 60 sq. ft. 42 lbs. | 1,666 | 1,870 | 1,978 | 2,044 | 2,149 | 2,263 | 2,365 | 2,470 | 2,575 | 2,683 | 3,178 | 3,538 |
| 6712  |  Lounge Chair, Armless, Casters/Glides 24" W x 27.25" D x 32" H Seat: 23.25" W x 18.25" D Seat Ht: 16.75" COM: 3 yds. COL: 60 sq. ft. 42 lbs. | 1,666 | 1,870 | 1,978 | 2,044 | 2,149 | 2,263 | 2,365 | 2,470 | 2,575 | 2,683 | 3,178 | 3,538 |
| 6711  | Lounge Chair, Arms, Glides 28.5" W x 29.25" D x 32" H Seat: 23.25" W x 18.25" D Seat Ht: 16.75" COM: 5.5 yds. COL: 110 sq. ft. 72 lbs. | 2,171 | 2,545 | 2,743 | 2,864 | 3,057 | 3,266 | 3,453 | 3,645 | 3,838 | 4,036 | 4,943 | 5,603 |
| 6716  | Lounge Chair, Arms, Casters 28.5" W x 29.25" D x 32" H Seat: 23.25" W x 18.25" D Seat Ht: 16.75" COM: 5.5 yds. COL: 110 sq. ft. 72 lbs. | 2,171 | 2,545 | 2,743 | 2,864 | 3,057 | 3,266 | 3,453 | 3,645 | 3,838 | 4,036 | 4,943 | 5,603 |
| 6717  | Lounge Chair, Arms, Casters/Glides 28.5" W x 29.25" D x 32" H Seat: 23.25" W x 18.25" D Seat Ht: 16.75" COM: 5.5 yds. COL: 110 sq. ft. 72 lbs. | 2,171 | 2,545 | 2,743 | 2,864 | 3,057 | 3,266 | 3,453 | 3,645 | 3,838 | 4,036 | 4,943 | 5,603 |

OPTIONS

| | | | | | |
|---------|-----------------------------------|-------|--------|----------------------------|-------|
| -P03-BW | Leather Pull Handle, Bright White | \$121 | -P03-B | Leather Pull Handle, Black | \$121 |
| -P03-S | Leather Pull Handle, Saddle | \$121 | -FG04 | Felt Glides | \$26 |
| -P03-SG | Leather Pull Handle, Stone Grey | \$121 | | | |

 = Available on quick-ship program.

All shipments for this series will be blanket-wrapped as standard. For customers located in Territory 1 who require cartoning, a 5% upcharge will be added to each product. Please contact client services for additional information.

GOGO LOUNGE | Designed by Qdesign

ORDERING REQUIREMENTS:

- Model number
- Upholstery selection
- Options, as applicable

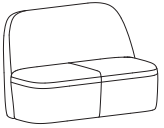
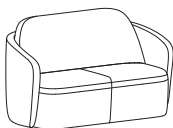
| MODEL | PRODUCT SPECIFICATIONS | FABRIC GRADES | | | | | | | | LEATHER | | | |
|---|---|---------------|-------|-------|-------|-------|-------|----------|-------|---------|-------|-------|-------|
| | | COM | A | 1 | 2 | 3 | 4 | COL 5 | 6 | 7 | 8 | L1 | L2 |
| 6720  | Love Seat, Armless, Glides 48" W x 27.25" D x 32" H Seat: 47.5" W x 18.25" D Seat Ht: 16.75" COM: 5 yds. COL: 100 sq. ft. 60 lbs. | 2,485 | 2,825 | 3,005 | 3,115 | 3,290 | 3,480 | 3,650 | 3,825 | 4,000 | 4,180 | 5,005 | 5,605 |
| 6721  | Love Seat, Arms, Glides 53" W x 29.25" D x 32" H Seat: 47.5" W x 18.25" D Seat Ht: 16.75" COM: 9 yds. COL: 180 sq. ft. 103 lbs. | 3,177 | 3,857 | 4,217 | 4,437 | 4,787 | 5,167 | 5,507 | 5,857 | 6,207 | 6,567 | 8,217 | 9,417 |

OPTIONS

-FG04 Felt Glides \$26

GOGO LOUNGE | Two-Tone Upholstery

UPHOLSTERY COMBINATIONS:

- For upholstery combinations, refer to the pricing below.
- When combining two COM/COV/COL fabrics, or fabrics with the same grade, add \$120 List per unit.
- When combining three or more COM/COV/COL fabrics, or fabrics with the same grade, add \$150 List per unit.
- When combining different grades of fabric, price will be based on the highest grade specified.
- Two-tone upholstery examples and yardage requirements for the most common combinations are listed below. Additional combinations available; please contact client services for yardage requirements and pricing.
- Note: Yardage amounts are based on fabric which is plain (i.e. non-directional) and a full 54" wide.
- Appropriate upholstery code must be included.

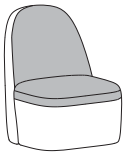

Code GG1

Model COM Requirement

6710 Front of Back & Seat Cushion = 1.25 yds.

6712 Balance of Chair = 2 yds.

6715

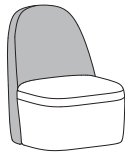

Code GG2

Model COM Requirement

6710 Back Upholstery = 2 yds.

6712 Balance of Chair = 1.5 yds.

6715



Code GG3

Model COM Requirement

6711 Back & Seat Cushion = 2.25 yds.

6716 Balance of Chair = 3.75 yds.

6717



Code GG4

Model COM Requirement

6711 Arm Panels/Outer Shell = 3 yds.

6716 Balance of Chair = 3 yds.

6717

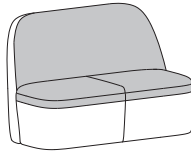

Code GG5

Model COM Requirement

6720 Front of Back & Seat Cushion = 2.25 yds.

Balance of Love Seat = 3 yds.

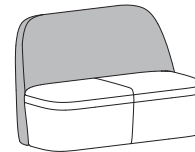

Code GG6

Model COM Requirement

6720 Back Upholstery = 3 yds.

Balance of Love Seat = 2.5 yds.

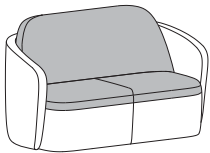

Code GG7

Model COM Requirement

6721 Back & Seat Cushion = 3.75 yds.

Balance of Love Seat = 5.25 yds.

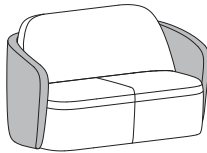

Code GG8

Model COM Requirement

6721 Arm Panels/Outer Shell = 4 yds.

Balance of Love Seat = 5 yds.

HADO BENCHES | Designed by Qdesign



SPECIFICATIONS:

- Square and rectangular benches and ottomans with wood legs.
- Wood legs offered in all standard and custom finishes on Ash.
- For custom wood finishes, please contact client services and add one-time upcharge of \$531 List per color per order.
- For Alabaster and Super Matte Sable Ash, premium wood finish upcharge applies. Refer to options section for pricing.
- 22" ottoman and 30" square bench feature 275 lb. weight capacity.
- 36" square bench, 48" rectangular bench and 60" rectangular bench feature 550 lb. weight capacity.
- Ottoman features 7¾" leg height clearance.
- Square and rectangular benches feature 12½" leg height clearance.
- Leg assembly required.
- All dimensions are nominal.
- Refer to terms and conditions for general information regarding fabrics, finishes, warranty, freight, complete condition of sales and more.

MINI-TAP POWER UNITS:

- Available on all benches and ottomans.
- Dimensions: 3" W x 3" D x 1.75" H
- Black and white color options.
- 72" electrical cord (no hardwire option available for this series).
- Placement is located under seat.
- Please specify front, left side or right side placement, as seated.
- For left or right side placement, unit will be centered as standard.
- For front placement, please specify left, center or right, as seated.
- UL listed.

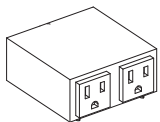

Mini-Tap 2 (MT2)
■ Two outlets.

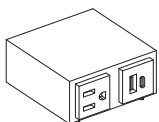



Mini-Tap 3 (MT3)
■ One outlet, one USB-A and one USB-C charging port.

All shipments for this series will be blanket-wrapped as standard. For customers located in Territory 1 who require cartoning, a 5% upcharge will be added to each product. Please contact client services for additional information.

HADO BENCHES | Designed by Qdesign

ORDERING REQUIREMENTS:

- Model number
- Leg finish
- Upholstery selection
- Options, as applicable

| MODEL | PRODUCT SPECIFICATIONS | FABRIC GRADES | | | | | | | | LEATHER | | | |
|---|--|---------------|-------|-------|-------|-------|-------|----------|-------|---------|-------|-------|-------|
| | | COM | A | 1 | 2 | 3 | 4 | COL 5 | 6 | 7 | 8 | L1 | L2 |
| 63522  | 22" Square Ottoman 22" W x 22" D x 15.75" H COM: 1.25 yds. COL: 25 sq. ft. 19 lbs. | 1,232 | 1,317 | 1,362 | 1,390 | 1,434 | 1,481 | 1,524 | 1,567 | 1,611 | 1,656 | 1,862 | 2,012 |
| 63530  | 30" Square Bench 30" W x 30" D x 19" H COM: 1.5 yds. COL: 30 sq. ft. 27 lbs. | 1,506 | 1,608 | 1,662 | 1,695 | 1,748 | 1,805 | 1,856 | 1,908 | 1,961 | 2,015 | 2,262 | 2,442 |
| 63536  | 36" Square Bench 36" W x 36" D x 19" H COM: 1.75 yds. COL: 35 sq. ft. 37 lbs. | 1,874 | 1,993 | 2,056 | 2,095 | 2,156 | 2,223 | 2,282 | 2,343 | 2,405 | 2,468 | 2,756 | 2,966 |

OPTIONS

| | | |
|----------|---|-------|
| -PFW01 | Premium Wood Leg Finish | \$12 |
| -NS04 | Non-Skid Glides | \$26 |
| -MT2-() | Mini-Tap Power Unit (2 power) | \$380 |
| -MT3-() | Mini-Tap Power Unit (1 power, 1 USB-A, 1 USB-C) | \$414 |

Note: please specify (-B) for black and (-W) for white on Mini-Tap Power Units.

 = Available on quick-ship program.

All shipments for this series will be blanket-wrapped as standard. For customers located in Territory 1 who require cartoning, a 5% upcharge will be added to each product. Please contact client services for additional information.

HADO BENCHES | Designed by Qdesign

ORDERING REQUIREMENTS:

- Model number
- Leg finish
- Upholstery selection
- Options, as applicable

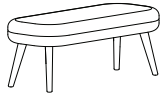
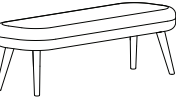
| MODEL | PRODUCT SPECIFICATIONS | FABRIC GRADES | | | | | | | | LEATHER | | | |
|---|--|---------------|-------|-------|-------|-------|-------|----------|-------|---------|-------|-------|-------|
| | | COM | A | 1 | 2 | 3 | 4 | COL 5 | 6 | 7 | 8 | L1 | L2 |
| 63548  | 48" Rectangular Bench 48" W x 20" D x 19" H COM: 2 yds. COL: 40 sq. ft. 38 lbs. | 1,838 | 1,974 | 2,046 | 2,090 | 2,160 | 2,236 | 2,304 | 2,374 | 2,444 | 2,516 | 2,846 | 3,086 |
| 63560  | 60" Rectangular Bench 60" W x 20" D x 19" H COM: 2.75 yds. COL: 55 sq. ft. 45 lbs. | 1,886 | 2,073 | 2,172 | 2,233 | 2,329 | 2,434 | 2,527 | 2,623 | 2,720 | 2,819 | 3,272 | 3,602 |

OPTIONS

| | | |
|---------|---|-------|
| -PFW01 | Premium Wood Leg Finish | \$12 |
| -NS04 | Non-Skid Glides | \$26 |
| -MT2(-) | Mini-Tap Power Unit (2 power) | \$380 |
| -MT3(-) | Mini-Tap Power Unit (1 power, 1 USB-A, 1 USB-C) | \$414 |

Note: please specify (-B) for black and (-W) for white on Mini-Tap Power Units.

 = Available on quick-ship program.

HADO BENCHES | Designed by Qdesign

UPHOLSTERY COMBINATIONS:

- For upholstery combinations, refer to the pricing below.
- When combining two COM/COV/COL fabrics, or fabrics with the same grade, add \$120 List per unit.
- When combining three or more COM/COV/COL fabrics, or fabrics with the same grade, add \$150 List per unit.
- When combining different grades of fabric, price will be based on the highest grade specified.
- Two-tone upholstery examples and yardage requirements for the most common combinations are listed below. Additional combinations available; please contact client services for yardage requirements and pricing.
- Note: Yardage amounts are based on fabric which is plain (i.e. non-directional) and a full 54" wide.
- Appropriate upholstery code must be included.



Code **HB1**
Model COM Requirement
 63522 Upholstered Platform = .5 yd.
 Balance of Bench = .75 yd.



Code **HB2**
Model COM Requirement
 63530 Upholstered Platform = .5 yd.
 Balance of Bench = 1 yd.



Code **HB3**
Model COM Requirement
 63536 Upholstered Platform = .5 yd.
 Balance of Bench = 1 yd.

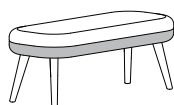

Code **HB4**
Model COM Requirement
 63548 Upholstered Platform = .75 yd.
 Balance of Bench = 1.25 yds.

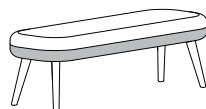

Code **HB5**
Model COM Requirement
 63560 Upholstered Platform = 1 yd.
 Balance of Bench = 2 yds.

HADO GUEST | Designed by Qdesign



SPECIFICATIONS:

- Metal legs available in standard and premium finishes. See below for options.
- For custom finish colors, please contact client services for pricing.
- 300 lb. weight capacity.
- All dimensions are nominal.
- Refer to terms and conditions for general information regarding fabrics, finishes, warranty, freight, complete condition of sales and more.

STANDARD METAL LEG FINISH COLORS:

- 0405 Charcoal Grey
- 0535 Metallic Silver
- 0199 Chrome
- 0630 Satin Black

PREMIUM METAL LEG FINISH COLORS:

- 0605 Matte Black
- 0705 Matte Cotton
- 0788 Glossy Cotton
- 0805 Oasis
- 0905 Mint
- 1005 Mercury
- 1105 Canary
- 1205 Stone
- 1305 Sage
- 1405 Ice Blue
- 1505 Clay

All shipments for this series will be blanket-wrapped as standard. For customers located in Territory 1 who require cartoning, a 5% upcharge will be added to each product. Please contact client services for additional information.

HADO GUEST | Designed by Qdesign

ORDERING REQUIREMENTS:

- Model number
- Leg finish
- Upholstery selection
- Options, as applicable

| MODEL | PRODUCT SPECIFICATIONS | FABRIC GRADES | | | | | | | | LEATHER | | | |
|---|--|---------------|-------|-------|-------|-------|-------|----------|-------|---------|-------|-------|-------|
| | | COM | A | 1 | 2 | 3 | 4 | COL 5 | 6 | 7 | 8 | L1 | L2 |
| 63111  | Guest Chair, 4-Leg Metal Base 18" W x 23.5" D x 31.5" H Seat: 18" W x 17.5" D Seat Ht: 17.5" COM: 1.5 yds. COL: 30 sq. ft. 16 lbs. | 1,371 | 1,473 | 1,527 | 1,560 | 1,613 | 1,670 | 1,721 | 1,773 | 1,826 | 1,880 | 2,127 | 2,307 |

OPTIONS

| | | |
|--------|--------------------------|-------|
| -PFM02 | Premium Metal Leg Finish | \$101 |
| -NSO4 | Non-Skid Glides | \$26 |

All shipments for this series will be blanket-wrapped as standard. For customers located in Territory 1 who require cartoning, a 5% upcharge will be added to each product. Please contact client services for additional information.

HADO GUEST | Designed by Qdesign

UPHOLSTERY COMBINATIONS:

- For upholstery combinations, refer to the pricing below.
- When combining two COM/COV/COL fabrics, or fabrics with the same grade, add \$120 List per unit.
- When combining three or more COM/COV/COL fabrics, or fabrics with the same grade, add \$150 List per unit.
- When combining different grades of fabric, price will be based on the highest grade specified.
- Two-tone upholstery examples and yardage requirements for the most common combinations are listed below. Additional combinations available; please contact client services for yardage requirements and pricing.
- Note: Yardage amounts are based on fabric which is plain (i.e. non-directional) and a full 54" wide.
- Appropriate upholstery code must be included.



| Code | HG1 |
|--------------|--------------------------------|
| <u>Model</u> | <u>COM Requirement</u> |
| 63111 | Seat = 1 yd. Back = .75 yd. |

All shipments for this series will be blanket-wrapped as standard. For customers located in Territory 1 who require cartoning, a 5% upcharge will be added to each product. Please contact client services for additional information.

HADO LOUNGE | Designed by Qdesign



SPECIFICATIONS:

- Lounge and love seat models available with wood or metal legs.
- Wood legs offered in all standard and custom finishes on Ash.
- For custom wood finishes, please contact client services and add one-time upcharge of \$531 List per color per order.
- For Alabaster and Super Matte Sable Ash, premium wood finish upcharge applies. Refer to options section for pricing.
- Metal legs available in standard and premium finishes. See below for options.
- For custom metal finish colors, please contact client services for pricing.
- Lounge chair features 350 lb. weight capacity. Love seat and sofa feature 700 lb. weight capacity.
- 7¾" leg height clearance.
- Leg assembly required.
- All dimensions are nominal.
- Refer to terms and conditions for general information regarding fabrics, finishes, warranty, freight, complete condition of sales and more.

STANDARD METAL LEG FINISH COLORS:

- 0405 Charcoal Grey
- 0535 Metallic Silver
- 0630 Satin Black
- Satin Chrome

PREMIUM METAL LEG FINISH COLORS:

- 0605 Matte Black
- 0705 Matte Cotton
- 0788 Glossy Cotton
- 0805 Oasis
- 0905 Mint
- 1005 Mercury
- 1105 Canary
- 1205 Stone
- 1305 Sage
- 1405 Ice Blue
- 1505 Clay

HADO LOUNGE | Designed by Qdesign

MINI-TAP POWER UNITS:

- Available on all lounge models.
- Dimensions: 3" W x 3" D x 1.75" H
- Black and white color options.
- 72" electrical cord (no hardwire option available for this series).
- Placement is located under seat.
- Please specify front, left side or right side placement, as seated.
- For left or right side placement, unit will be centered as standard.
- For front placement, please specify left, center or right, as seated.
- UL listed.

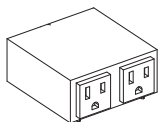

Mini-Tap 2 (MT2)

- Two outlets.

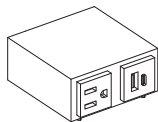

Mini-Tap 3 (MT3)

- One outlet, one USB-A and one USB-C charging port.

POWER MATRIX 1 UNIT (PX1):

- Available on all lounge models.
- One outlet, one USB-A and one USB-C charging port.
- Dimensions: 5.25" L x 2.5" W
- Black and white finish options.
- 120" electrical cord (no hardwire option available for this series).
- Unit will be positioned on right side arm panel, as seated, unless otherwise specified.
- UL listed.

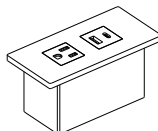





All shipments for this series will be blanket-wrapped as standard. For customers located in Territory 1 who require cartoning, a 5% upcharge will be added to each product. Please contact client services for additional information.

HADO LOUNGE | Designed by Qdesign

ORDERING REQUIREMENTS:

- Model number
- Leg finish
- Upholstery selection
- Options, as applicable

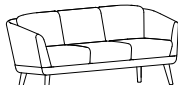
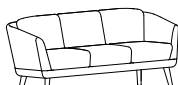
| MODEL | PRODUCT SPECIFICATIONS | FABRIC GRADES | | | | | | | | | | LEATHER | |
|---|---|---------------|-------|-------|-------|-------|-------|----------|-------|-------|-------|---------|--------|
| | | COM | A | 1 | 2 | 3 | 4 | COL 5 | 6 | 7 | 8 | L1 | L2 |
| 63224  | Lounge Chair, Wood Legs 33" W x 34.5" D x 29.5" H Seat: 22" W x 21.5" D Seat Ht: 17" COM: 4.5 yds. COL: 90 sq. ft. 67 lbs. | 2,624 | 2,930 | 3,092 | 3,191 | 3,349 | 3,520 | 3,673 | 3,830 | 3,988 | 4,150 | 4,892 | 5,432 |
| 63224-M  | Lounge Chair, Metal Legs 33" W x 34.5" D x 29.5" H Seat: 22" W x 21.5" D Seat Ht: 17" COM: 4.5 yds. COL: 90 sq. ft. 67 lbs. | 2,624 | 2,930 | 3,092 | 3,191 | 3,349 | 3,520 | 3,673 | 3,830 | 3,988 | 4,150 | 4,892 | 5,432 |
| 63324  | Love Seat, Wood Legs 57 W x 34.5" D x 29.5" H Seat: 46" W x 21.5" D Seat Ht: 17" COM: 8.25 yds. COL: 165 sq. ft. 95 lbs. | 3,291 | 3,852 | 4,149 | 4,331 | 4,620 | 4,933 | 5,214 | 5,502 | 5,791 | 6,088 | 7,449 | 8,439 |
| 63324-M  | Love Seat, Metal Legs 57 W x 34.5" D x 29.5" H Seat: 46" W x 21.5" D Seat Ht: 17" COM: 8.25 yds. COL: 165 sq. ft. 95 lbs. | 3,291 | 3,852 | 4,149 | 4,331 | 4,620 | 4,933 | 5,214 | 5,502 | 5,791 | 6,088 | 7,449 | 8,439 |
| 63424  | Sofa, Wood Legs 80" W x 34.5" D x 29.5" H Seat: 69" W x 21.5" D Seat Ht: 17" COM: 10.25 yds. COL: 205 sq. ft. 142 lbs. | 4,389 | 5,086 | 5,455 | 5,681 | 6,040 | 6,429 | 6,778 | 7,136 | 7,495 | 7,864 | 9,555 | 10,785 |
| 63424-M  | Sofa, Metal Legs 80" W x 34.5" D x 29.5" H Seat: 69" W x 21.5" D Seat Ht: 17" COM: 10.25 yds. COL: 205 sq. ft. 142 lbs. | 4,389 | 5,086 | 5,455 | 5,681 | 6,040 | 6,429 | 6,778 | 7,136 | 7,495 | 7,864 | 9,555 | 10,785 |

OPTIONS

| | | |
|----------|---|-------|
| -PFM02 | Premium Metal Leg Finish | \$101 |
| -PFW01 | Premium Wood Leg Finish | \$12 |
| -NS04 | Non-Skid Glides | \$26 |
| -MT2-() | Mini-Tap Power Unit (2 power) | \$380 |
| -MT3-() | Mini-Tap Power Unit (1 power, 1 USB-A, 1 USB-C) | \$414 |
| -PX1-() | Power Matrix 1 (1 power, 1 USB-A, 1 USB-C) | \$534 |

Note: please specify (-B) for black and (-W) for white on Mini-Tap Power Units and Power Matrix.

HADO LOUNGE | Designed by Qdesign

UPHOLSTERY COMBINATIONS:

- For upholstery combinations, refer to the pricing below.
- When combining two COM/COV/COL fabrics, or fabrics with the same grade, add \$120 List per unit.
- When combining three or more COM/COV/COL fabrics, or fabrics with the same grade, add \$150 List per unit.
- When combining different grades of fabric, price will be based on the highest grade specified.
- Two-tone upholstery examples and yardage requirements for the most common combinations are listed below. Additional combinations available; please contact client services for yardage requirements and pricing.
- Note: Yardage amounts are based on fabric which is plain (i.e. non-directional) and a full 54" wide.
- Appropriate upholstery code must be included.



| | |
|--------------|------------------------------|
| Code | HL1 |
| <u>Model</u> | <u>COM Requirement</u> |
| 63224 | Upholstered Platform = 1 yd. |
| 63224-M | Balance of Chair = 4.5 yds. |

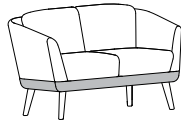

| | |
|--------------|----------------------------------|
| Code | HL2 |
| <u>Model</u> | <u>COM Requirement</u> |
| 63324 | Upholstered Platform = 1.25 yds. |
| 63324-M | Balance of Love Seat = 7.25 yds. |

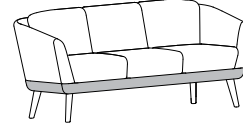

| | |
|--------------|----------------------------------|
| Code | HL3 |
| <u>Model</u> | <u>COM Requirement</u> |
| 63424 | Upholstered Platform = 1.25 yds. |
| 63424-M | Balance of Sofa = 9 yds. |

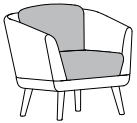

| | |
|--------------|---------------------------------|
| Code | HL4 |
| <u>Model</u> | <u>COM Requirement</u> |
| 63224 | Back & Seat Cushion = 1.75 yds. |
| 63224-M | Balance of Chair = 4 yds. |

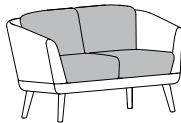

| | |
|--------------|-------------------------------|
| Code | HL5 |
| <u>Model</u> | <u>COM Requirement</u> |
| 63324 | Back & Seat Cushion = 4 yds. |
| 63324-M | Balance of Love Seat = 5 yds. |

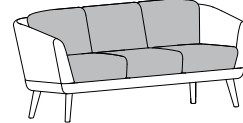

| | |
|--------------|--------------------------------|
| Code | HL6 |
| <u>Model</u> | <u>COM Requirement</u> |
| 63424 | Back & Seat Cushion = 5.5 yds. |
| 63424-M | Balance of Sofa = 5.25 yds. |



| | |
|--------------|----------------------------------|
| Code | HL7 |
| <u>Model</u> | <u>COM Requirement</u> |
| 63224 | Back & Seat Cushion/ |
| 63224-M | Upholstered Platform = 3.75 yds. |
| | Balance of Chair = 2 yds. |

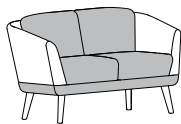

| | |
|--------------|----------------------------------|
| Code | HL8 |
| <u>Model</u> | <u>COM Requirement</u> |
| 63324 | Back & Seat Cushion/ |
| 63324-M | Upholstered Platform = 2.5 yds. |
| | Balance of Love Seat = 6.75 yds. |

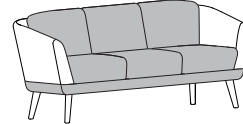

| | |
|--------------|---------------------------------|
| Code | HL9 |
| <u>Model</u> | <u>COM Requirement</u> |
| 63424 | Back & Seat Cushion/ |
| 63424-M | Upholstered Platform = 2.5 yds. |
| | Balance of Sofa = 8.25 yds. |

All shipments for this series will be blanket-wrapped as standard. For customers located in Territory 1 who require cartoning, a 5% upcharge will be added to each product. Please contact client services for additional information.

HADO MEETING TABLES | Designed by Qdesign



SPECIFICATIONS:

- Round, square and rectangular top shapes.
- Three top surface options: wood veneer, laminate and Fenix.
- Wood veneer tops and wood legs available in all standard and custom finishes on Ash.
- For custom wood finishes, please contact client services and add one-time upcharge of \$531 List per color per order.
- For Alabaster and Super Matte Sable Ash, premium wood finish upcharge applies. Refer to options section for pricing.
- For custom laminate options, add \$649 List per color per order. Pre-approval required, please contact client services.
- Fenix offered in five standard colorways.
- For non-standard Fenix colors, please contact client services for pricing.
- For veneer, standard wood grain and solid black laminate, as well as Fenix Nero Ingo (black), edge will match top finish color, unless specified otherwise.
- For all other solid color laminate and Fenix tops, edge to match specified leg finish.
- Leg assembly required.
- All dimensions are nominal.
- Refer to terms and conditions for general information regarding finishes, warranty, freight, complete condition of sales and more.

EDGE DETAIL:

Laminate*/Veneer/Fenix Top



*Please note that laminate thickness is nominal and may vary.

TOP SHAPES:

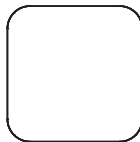
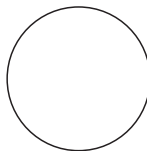



All shipments for this series will be blanket-wrapped as standard. For customers located in Territory 1 who require cartoning, a 5% upcharge will be added to each product. Please contact client services for additional information.

HADO MEETING TABLES | Designed by Qdesign

ORDERING REQUIREMENTS:

- Model number
- Top surface material
- Top finish, as applicable
- Leg finish
- Options, as applicable

| MODEL | DIMENSIONS | veneer top (-V) | laminate top (-L) | fenix top (-FE) | weight | |
|---|-----------------|--------------------|-------------------|-----------------|--------|---------|
|  <p>Round Top</p> | 6320-3629-() | 36"D x 29"H | 3,282 | 3,003 | 3,418 | 37 lbs. |
| | 6320-4229-() | 42"D x 29"H | 3,483 | 3,195 | 3,759 | 46 lbs. |
| | 6320-4829-() | 48"D x 29"H | 3,623 | 3,327 | 4,064 | 55 lbs. |
|  <p>Square Top</p> | 6325-363629-() | 36"W x 36"D x 29"H | 3,404 | 3,123 | 3,538 | 37 lbs. |
| | 6325-424229-() | 42"W x 42"D x 29"H | 3,594 | 3,305 | 3,869 | 46 lbs. |
| | 6325-484829-() | 48"W x 48"D x 29"H | 3,738 | 3,440 | 4,177 | 55 lbs. |
|  <p>Rectangular Top</p> | 6325-603029-() | 60"W x 30"D x 29"H | 3,602 | 3,312 | 3,888 | 48 lbs. |
| | 6325-723029-() | 72"W x 30"D x 29"H | 4,896 | 4,427 | 5,118 | 53 lbs. |
| | 6325-723629-() | 72"W x 36"D x 29"H | 4,984 | 4,517 | 5,346 | 58 lbs. |

OPTIONS

- PFW05 Premium Wood Finish \$85
- NS04 Non-Skid Glides \$26

 = Available on quick-ship program.

All shipments for this series will be blanket-wrapped as standard. For customers located in Territory 1 who require cartoning, a 5% upcharge will be added to each product. Please contact client services for additional information.

HADO OCCASIONAL TABLES | Designed by Qdesign



SPECIFICATIONS:

- Round, square and rectangular top shapes.
- Two heights: 16" and 20".
- Five top surface options: wood veneer, laminate, Fenix, solid surface and Starphire® glass.
- Wood veneer tops and wood legs available in all standard and custom finishes on Ash.
- For custom wood finishes, please contact client services and add one-time upcharge of \$531 List per color per order.
- For Alabaster and Super Matte Sable Ash, premium wood finish upcharge applies. Refer to options section for pricing.
- For custom laminate options, add \$649 List per color per order. Pre-approval required, please contact client services.
- Fenix offered in five standard colorways.
- For non-standard Fenix colors, please contact client services for pricing.
- For veneer, standard wood grain and solid black laminate, as well as Fenix Nero Ingo (black), edge will match top finish color, unless specified otherwise.
- For all other solid color laminate and Fenix tops, edge to match specified leg finish.
- Glass tops are back-painted white as standard.
- Solid surface available in white only.
- Back-painted glass and solid surface tops feature exposed plywood with a clear coat finish.
- Leg assembly required.
- All dimensions are nominal.
- Refer to terms and conditions for general information regarding finishes, warranty, freight, complete condition of sales and more.

EDGE DETAIL:

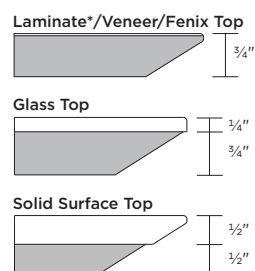

*Please note that laminate thickness is nominal and may vary.

TOP SHAPES:

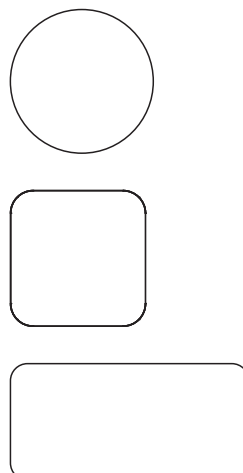



All shipments for this series will be blanket-wrapped as standard. For customers located in Territory 1 who require cartoning, a 5% upcharge will be added to each product. Please contact client services for additional information.

HADO OCCASIONAL TABLES | Designed by Qdesign

ORDERING REQUIREMENTS:

- Model number
- Top surface material
- Top finish, as applicable
- Leg finish
- Options, as applicable

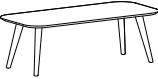
| MODEL | VENEER TOP (-V) | LAMINATE TOP (-L) | FENIX TOP (-FE) | SOLID SURFACE TOP (-SF) | BACK-PAINTED GLASS TOP (-GL) | WEIGHT |
|---|----------------------------------|----------------------------------|----------------------------------|----------------------------------|----------------------------------|--|
|  Round Top 6320-2116-() 6320-3016-() 6320-3616-() 6320-4216-() | 1,353 2,131 2,644 2,764 | 1,270 1,936 2,366 2,476 | 1,411 2,224 2,781 3,040 | 1,525 2,630 3,365 3,836 | 1,479 2,283 2,782 2,961 | 18 lbs. 26 lbs. 33 lbs. 42 lbs. |
|  Square Top 6325-222216-() 6325-303016-() 6325-363616-() 6325-424216-() | 1,376 2,155 2,675 2,799 | 1,292 1,957 2,398 2,510 | 1,447 2,245 2,813 3,074 | 1,624 2,651 3,397 3,870 | 1,500 2,303 2,814 2,995 | 18 lbs. 26 lbs. 33 lbs. 42 lbs. |
|  Rectangular Top 6325-482216-() | 2,454 | 2,201 | 2,539 | 3,089 | 2,548 | 29 lbs. |

OPTIONS

- PFW04 Premium Wood Finish \$46
- NS04 Non-Skid Glides \$26



 = Available on quick-ship program (veneer, laminate, Fenix and solid surface tops only).

All shipments for this series will be blanket-wrapped as standard. For customers located in Territory 1 who require cartoning, a 5% upcharge will be added to each product. Please contact client services for additional information.

HADO OCCASIONAL TABLES | Designed by Qdesign

ORDERING REQUIREMENTS:

- Model number
- Top surface material
- Top finish, as applicable
- Leg finish
- Options, as applicable

| MODEL | VENEER TOP (-V) | LAMINATE TOP (-L) | FENIX TOP (-FE) | SOLID SURFACE TOP (-SF) | BACK-PAINTED GLASS TOP (-GL) | WEIGHT |
|---|-----------------|-------------------|-----------------|-------------------------|------------------------------|---------|
|  <p>Round Top 6320-2120-()</p> | 1,524 | 1,442 | 1,583 | 1,697 | 1,650 | 19 lbs. |
|  <p>Square Top 6325-222220-()</p> | 1,558 | 1,470 | 1,625 | 1,802 | 1,680 | 19 lbs. |

OPTIONS

- PFW04 Premium Wood Finish \$46
- NS04 Non-Skid Glides \$26

 = Available on quick-ship program (veneer, laminate, Fenix and solid surface tops only).

All shipments for this series will be blanket-wrapped as standard. For customers located in Territory 1 who require cartoning, a 5% upcharge will be added to each product. Please contact client services for additional information.

HOOM GUEST | Designed by Gower + Woolf



SPECIFICATIONS:

- Four base options available: 4-leg wood, 4-leg metal, 4-prong swivel with glides and 5-prong with casters.
- 4-prong swivel base models with glides feature self-return.
- 5-prong base models with casters feature height-adjustable tilt-lock mechanism.
- Metal bases offered in standard and premium finishes. Please refer to listing below.
- For custom metal finish colors, please contact client services for pricing.
- 4-leg wood bases offered in all standard finishes on Ash.
- For Alabaster and Super Matte Sable Ash, premium wood finish upcharge applies. Refer to options section for pricing.
- For custom wood finishes, please add \$531 List per color per order.
- 300 lb. weight capacity.
- All dimensions are nominal.
- Refer to terms and conditions for general information regarding fabrics, finishes, warranty, freight, complete condition of sales and more.

STANDARD METAL BASE FINISH COLORS:

- 0405 Charcoal Grey
- 0535 Metallic Silver
- 0199 Chrome (4-leg base only)
- 0299 Polished Aluminum (swivel base only)
- 0630 Satin Black

PREMIUM METAL BASE FINISH COLORS:









- 0605 Matte Black
- 0705 Matte Cotton
- 0788 Glossy Cotton
- 0805 Oasis
- 0905 Mint
- 1005 Mercury
- 1105 Canary
- 1205 Stone
- 1305 Sage
- 1405 Ice Blue
- 1505 Clay

All shipments for this series will be blanket-wrapped as standard. For customers located in Territory 1 who require cartoning, a 5% upcharge will be added to each product. Please contact client services for additional information.

HOOM GUEST | Designed by Gower + Woolf

ORDERING REQUIREMENTS:

- Model number
- Base finish
- Upholstery selection
- Options, as applicable

| MODEL | PRODUCT SPECIFICATIONS | FABRIC GRADES | | | | | | | | | | LEATHER | |
|--|---|---------------|-------|-------|-------|-------|-------|----------|-------|-------|-------|---------|-------|
| | | COM | A | 1 | 2 | 3 | 4 | COL 5 | 6 | 7 | 8 | L1 | L2 |
| 7001  |  Guest Chair, 4-Leg Metal Base 24" W x 24" D x 31.5" H Seat: 18.5" W x 18" D Seat Ht: 17.75" COM: 1.75 yds. COL: 35 sq. ft. 24 lbs. | 1,321 | 1,440 | 1,503 | 1,542 | 1,603 | 1,670 | 1,729 | 1,790 | 1,852 | 1,915 | 2,203 | 2,413 |
| 7003-G  |  Guest Chair, 4-Prong Swivel Base, Glides 24" W x 24" D x 31.75" H Seat: 18.5" W x 17.5" D Seat Ht: 18.25" COM: 1.75 yds. COL: 35 sq. ft. 24 lbs. | 1,517 | 1,636 | 1,699 | 1,738 | 1,799 | 1,866 | 1,925 | 1,986 | 2,048 | 2,111 | 2,399 | 2,609 |
| 7003-C  |  Guest Chair, 5-Prong Base, Height-Adjustable Tilt-Lock Mechanism, Casters 24" W x 24" D x 31.25" H Seat: 18.5" W x 17.5" D Seat Ht: 17.75" COM: 1.75 yds. COL: 35 sq. ft. 24 lbs. | 1,579 | 1,698 | 1,761 | 1,800 | 1,861 | 1,928 | 1,987 | 2,048 | 2,110 | 2,173 | 2,461 | 2,671 |
| 7004  |  Guest Chair, 4-Leg Wood Base 24" W x 24" D x 31" H Seat: 18.5" W x 17.5" D Seat Ht: 17.5" COM: 1.75 yds. COL: 35 sq. ft. 26 lbs. | 1,567 | 1,686 | 1,749 | 1,788 | 1,849 | 1,916 | 1,975 | 2,036 | 2,098 | 2,161 | 2,449 | 2,659 |

OPTIONS

| | | |
|---------|---|-------|
| -PFM02 | Premium Metal Base Finish | \$101 |
| -PFW02 | Premium Wood Leg Finish | \$23 |
| -NS04 | Non-Skid Glides | \$26 |
| -STC02 | Soft Tread Casters (model 7003-C only) | \$33 |
| -STLC02 | Soft Tread Self-Locking Casters (model 7003-C only) | \$63 |
| -GDO4 | Glides (model 7003-C only) | \$30 |

 = Available on quick-ship program (0535 Metallic Silver, 0199 Chrome, 0299 Polished Aluminum and standard wood base finishes only).

All shipments for this series will be blanket-wrapped as standard. For customers located in Territory 1 who require cartoning, a 5% upcharge will be added to each product. Please contact client services for additional information.

HOOM GUEST | Designed by Gower + Woolf

UPHOLSTERY COMBINATIONS:

- For upholstery combinations, refer to the pricing below.
- When combining two COM/COV/COL fabrics, or fabrics with the same grade, add \$120 List per unit.
- When combining three or more COM/COV/COL fabrics, or fabrics with the same grade, add \$150 List per unit.
- When combining different grades of fabric, price will be based on the highest grade specified.
- Two-tone upholstery examples and yardage requirements for the most common combinations are listed below. Additional combinations available; please contact client services for yardage requirements and pricing.
- Note: Yardage amounts are based on fabric which is plain (i.e. non-directional) and a full 54" wide.
- Appropriate upholstery code must be included.



| | |
|--------------|--|
| Code | HM1 |
| <u>Model</u> | <u>COM Requirement</u> |
| All | Seat Cushion = .75 yd. Balance of Chair = 1.25 yds. |

All shipments for this series will be blanket-wrapped as standard. For customers located in Territory 1 who require cartoning, a 5% upcharge will be added to each product. Please contact client services for additional information.

HOOM LOUNGE | Designed by Gower + Woolf



SPECIFICATIONS:

- Two base options available: 4-leg wood and 4-prong swivel base with self-return.
- 4-prong swivel base available with or without rocker mechanism and offered in standard and premium finishes. Please refer to listing below.
- For custom metal finish colors, please contact client services for pricing.
- 4-leg wood base offered in all standard finishes on Ash.
- For custom wood finishes, please add \$531 List per color per order.
- For Alabaster and Super Matte Sable Ash, premium wood finish upcharge applies. Refer to options section for pricing.
- 300 lb. weight capacity.
- All dimensions are nominal.
- Refer to terms and conditions for general information regarding fabrics, finishes, warranty, freight, complete condition of sales and more.

STANDARD METAL BASE FINISH COLORS:

- 0405 Charcoal Grey
- 0535 Metallic Silver
- 0299 Polished Aluminum
- 0630 Satin Black

PREMIUM METAL BASE FINISH COLORS:







- 0605 Matte Black
- 0705 Matte Cotton
- 0788 Glossy Cotton
- 0805 Oasis
- 0905 Mint
- 1005 Mercury
- 1105 Canary
- 1205 Stone
- 1305 Sage
- 1405 Ice Blue
- 1505 Clay

All shipments for this series will be blanket-wrapped as standard. For customers located in Territory 1 who require cartoning, a 5% upcharge will be added to each product. Please contact client services for additional information.

HOOM LOUNGE | Designed by Gower + Woolf

ORDERING REQUIREMENTS:

- Model number
- Base finish
- Upholstery selection
- Options, as applicable

| MODEL | PRODUCT SPECIFICATIONS | FABRIC GRADES | | | | | | | | LEATHER | | | |
|--|---|---------------|-------|-------|-------|-------|-------|----------|-------|---------|-------|-------|-------|
| | | COM | A | 1 | 2 | 3 | 4 | COL 5 | 6 | 7 | 8 | L1 | L2 |
| 7053  |  Lounge Chair, 4-Prong Swivel Base 26.5" W x 26" D x 29.5" H Seat: 21" W x 18.5" D Seat Ht: 16.75" COM: 2.5 yds. COL: 50 sq. ft. 38 lbs. | 1,791 | 1,961 | 2,051 | 2,106 | 2,194 | 2,289 | 2,374 | 2,461 | 2,549 | 2,639 | 3,051 | 3,351 |
| 7053-RM01  |  Lounge Chair, 4-Prong Swivel Base with Rocker 26.5" W x 26" D x 29.5" H Seat: 21" W x 18.5" D Seat Ht: 16.75" COM: 2.5 yds. COL: 50 sq. ft. 34 lbs. | 1,885 | 2,055 | 2,145 | 2,200 | 2,288 | 2,383 | 2,468 | 2,555 | 2,643 | 2,733 | 3,145 | 3,445 |
| 7054  |  Lounge Chair, 4-Leg Wood Base 26.5" W x 26" D x 29.5" H Seat: 21" W x 18.5" D Seat Ht: 16.5" COM: 2.5 yds. COL: 50 sq. ft. 35 lbs. | 1,740 | 1,910 | 2,000 | 2,055 | 2,143 | 2,238 | 2,323 | 2,410 | 2,498 | 2,588 | 3,000 | 3,300 |

OPTIONS

| | | |
|--------|---------------------------|-------|
| -PFM02 | Premium Metal Base Finish | \$101 |
| -PFW02 | Premium Wood Leg Finish | \$23 |
| -NS04 | Non-Skid Glides | \$26 |

 = Available on quick-ship program (0535 Metallic Silver, 0299 Polished Aluminum and standard wood base finishes only).

All shipments for this series will be blanket-wrapped as standard. For customers located in Territory 1 who require cartoning, a 5% upcharge will be added to each product. Please contact client services for additional information.

HOOM LOUNGE | Designed by Gower + Woolf

UPHOLSTERY COMBINATIONS:

- For upholstery combinations, refer to the pricing below.
- When combining two COM/COV/COL fabrics, or fabrics with the same grade, add \$120 List per unit.
- When combining three or more COM/COV/COL fabrics, or fabrics with the same grade, add \$150 List per unit.
- When combining different grades of fabric, price will be based on the highest grade specified.
- Two-tone upholstery examples and yardage requirements for the most common combinations are listed below. Additional combinations available; please contact client services for yardage requirements and pricing.
- Note: Yardage amounts are based on fabric which is plain (i.e. non-directional) and a full 54" wide.
- Appropriate upholstery code must be included.



| | |
|--------------|---|
| Code | HM2 |
| <u>Model</u> | <u>COM Requirement</u> |
| All | Seat Cushion = .75 yd. Balance of Chair = 2 yds. |



| | |
|--------------|--|
| Code | HM3 |
| <u>Model</u> | <u>COM Requirement</u> |
| All | Inside Back and Seat Cushion = 1.25 yds. Balance of Chair = 1.75 yds. |

All shipments for this series will be blanket-wrapped as standard. For customers located in Territory 1 who require cartoning, a 5% upcharge will be added to each product. Please contact client services for additional information.

HOOM STOOLS | Designed by Gower + Woolf



SPECIFICATIONS:

- Bar and counter-height models.
- Two base options available: 4-leg wood and wire rod metal.
- 4-leg wood base models feature chrome stretcher bar (not available in other finishes).
- Wire rod metal base available in standard and premium finishes. See below for options.
- For custom metal finish colors, please contact client services for pricing.
- 4-leg wood base offered in all standard finishes on Ash.
- For custom wood finishes, please add \$531 List per color per order.
- For Alabaster and Super Matte Sable Ash, premium wood finish upcharge applies. Refer to options section for pricing.
- 30" bar-height stool features footrest with 12.5" clearance from the floor.
- 25" counter-height stool features footrest with 7.5" clearance from the floor.
- 300 lb. weight capacity.
- Optional glides for hard surface flooring.
- All dimensions are nominal.
- Refer to terms and conditions for general information regarding fabrics, finishes, warranty, freight, complete condition of sales and more.

STANDARD METAL BASE FINISH COLORS:

- 0405 Charcoal Grey
- 0535 Metallic Silver
- 0199 Chrome
- 0630 Satin Black

PREMIUM METAL BASE FINISH COLORS:









- 0605 Matte Black
- 0705 Matte Cotton
- 0788 Glossy Cotton
- 0805 Oasis
- 0905 Mint
- 1005 Mercury
- 1105 Canary
- 1205 Stone
- 1305 Sage
- 1405 Ice Blue
- 1505 Clay

All shipments for this series will be blanket-wrapped as standard. For customers located in Territory 1 who require cartoning, a 5% upcharge will be added to each product. Please contact client services for additional information.

HOOM STOOLS | Designed by Gower + Woolf

ORDERING REQUIREMENTS:

- Model number
- Base finish
- Upholstery selection
- Options, as applicable

| MODEL | PRODUCT SPECIFICATIONS | FABRIC GRADES | | | | | | | | | | LEATHER | |
|---|---|---------------|-------|-------|-------|-------|-------|-------|-------|-------|-------|---------|-------|
| | | COM | A | 1 | 2 | 3 | 4 | COL 5 | 6 | 7 | 8 | L1 | L2 |
| 7012-25  |  Counter-Height Stool, Wire Rod Metal Base 21.25" W x 23" D x 38" H Seat: 17" W x 15.5" D Seat Ht: 25" COM: 1.25 yd. COL: 25 sq. ft. 23 lbs. | 1,376 | 1,461 | 1,506 | 1,534 | 1,578 | 1,625 | 1,668 | 1,711 | 1,755 | 1,800 | 2,006 | 2,156 |
| 7012-30  |  Bar-Height Stool, Wire Rod Metal Base 21.25" W x 23" D x 41" H Seat: 17" W x 15.5" D Seat Ht: 30" COM: 1.25 yd. COL: 25 sq. ft. 25 lbs. | 1,392 | 1,477 | 1,522 | 1,550 | 1,594 | 1,641 | 1,684 | 1,727 | 1,771 | 1,816 | 2,022 | 2,172 |
| 7014-25  |  Counter-Height Stool, 4-Leg Wood Base 21.25" W x 23" D x 38" H Seat: 17" W x 15.5" D Seat Ht: 25" COM: 1.25 yd. COL: 25 sq. ft. 21 lbs. | 1,738 | 1,823 | 1,868 | 1,896 | 1,940 | 1,987 | 2,030 | 2,073 | 2,117 | 2,162 | 2,368 | 2,518 |
| 7014-30  |  Bar-Height Stool, 4-Leg Wood Base 21.25" W x 23" D x 41" H Seat: 17" W x 15.5" D Seat Ht: 30" COM: 1.25 yd. COL: 25 sq. ft. 23 lbs. | 1,707 | 1,792 | 1,837 | 1,865 | 1,909 | 1,956 | 1,999 | 2,042 | 2,086 | 2,131 | 2,337 | 2,487 |

OPTIONS

| | | |
|--------|--|-------|
| -PFM02 | Premium Metal Base Finish | \$101 |
| -PFW02 | Premium Wood Base Finish | \$23 |
| -CG02 | Clear Glides (wire rod base models only) | \$12 |
| -FG04 | Felt Glides | \$26 |

 = Available on quick-ship program (0535 Metallic Silver, 0199 Chrome and standard wood base finishes only).

All shipments for this series will be blanket-wrapped as standard. For customers located in Territory 1 who require cartoning, a 5% upcharge will be added to each product. Please contact client services for additional information.

HOOM STOOLS | Designed by Gower + Woolf

UPHOLSTERY COMBINATIONS:

- For upholstery combinations, refer to the pricing below.
- When combining two COM/COV/COL fabrics, or fabrics with the same grade, add \$120 List per unit.
- When combining three or more COM/COV/COL fabrics, or fabrics with the same grade, add \$150 List per unit.
- When combining different grades of fabric, price will be based on the highest grade specified.
- Two-tone upholstery examples and yardage requirements for the most common combinations are listed below. Additional combinations available; please contact client services for yardage requirements and pricing.
- Note: Yardage amounts are based on fabric which is plain (i.e. non-directional) and a full 54" wide.
- Appropriate upholstery code must be included.



| | |
|--------------|--|
| Code | HM4 |
| <u>Model</u> | <u>COM Requirement</u> |
| All | Seat Cushion = .5 yd. Balance of Upholstery = 1 yd. |

KENZIE OCCASIONAL TABLES | Designed by David Dahl

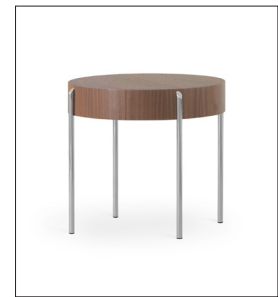

SPECIFICATIONS:

- Four table surface options: wood veneer, laminate, solid surface, or back-painted glass.
- Edge offered in wood veneer and laminate only.
- Two wood species available: Maple and Walnut.
- For custom wood finishes, please contact client services and add one-time upcharge of \$531 List per color per order.
- For Super Matte Sable Maple, premium wood finish upcharge applies. Refer to options section for pricing.
- For custom laminate finishes, add \$649 List per order per color. Pre-approval required, please contact client services.
- Glass tops are back-painted white as standard.
- Solid surface available in white only.
- Metal legs offered in standard and premium finishes. Please refer to listing below.
- For custom metal finish colors, please contact client services for pricing.
- All dimensions are nominal.
- Refer to terms and conditions for general information regarding finishes, warranty, freight, complete condition of sales and more.

STANDARD METAL LEG FINISH COLORS:

- 0405 Charcoal Grey
- 0535 Metallic Silver
- 0199 Chrome
- 0630 Satin Black

PREMIUM METAL LEG FINISH COLORS:



- 0605 Matte Black
- 0705 Matte Cotton
- 0788 Glossy Cotton
- 0805 Oasis
- 0905 Mint
- 1005 Mercury
- 1105 Canary
- 1205 Stone
- 1305 Sage
- 1405 Ice Blue
- 1505 Clay

All shipments for this series will be blanket-wrapped as standard. For customers located in Territory 1 who require cartoning, a 5% upcharge will be added to each product. Please contact client services for additional information.

KENZIE OCCASIONAL TABLES | Designed by David Dahl

ORDERING REQUIREMENTS:

- Model number
- Top surface material
- Top finish, as applicable
- Edge surface material
- Edge finish
- Leg finish
- Options, as applicable

| | MODEL | VENEER (-V) OR LAMINATE (-L) TOP | SOLID SURFACE (-SF) TOP | BACK-PAINTED GLASS TOP (-GL) | WEIGHT |
|---|-------------------------|----------------------------------|-------------------------|------------------------------|---------|
|  | 16" Height Table | | | | |
| | 700-1916-() | 1,433 | 1,642 | 1,552 | 15 lbs. |
| | 700-2116-() | 1,579 | 1,834 | 1,730 | 16 lbs. |
| | 700-2916-() | 2,015 | 2,709 | 2,219 | 22 lbs. |
| | 700-3616-() | 2,492 | 3,491 | 2,848 | 29 lbs. |
|  | 18" Height Table | | | | |
| | 700-1918-() | 1,451 | 1,660 | 1,573 | 16 lbs. |
| | 700-2118-() | 1,601 | 1,856 | 1,751 | 17 lbs. |
| | 700-2918-() | 2,035 | 2,729 | 2,239 | 23 lbs. |
| | 700-3618-() | 2,513 | 3,512 | 2,866 | 30 lbs. |
|  | 20" Height Table | | | | |
| | 700-1920-() | 1,474 | 1,683 | 1,594 | 17 lbs. |
| | 700-2120-() | 1,620 | 1,875 | 1,771 | 18 lbs. |
| | 700-2920-() | 2,058 | 2,752 | 2,263 | 24 lbs. |
| | 700-3620-() | 2,533 | 3,532 | 2,889 | 31 lbs. |

OPTIONS

| | | |
|--------|-------------------------------------|-------|
| -PFM02 | Premium Metal Leg Finish | \$101 |
| -PFW04 | Premium Wood Top and/or Edge Finish | \$46 |

All shipments for this series will be blanket-wrapped as standard. For customers located in Territory 1 who require cartoning, a 5% upcharge will be added to each product. Please contact client services for additional information.

KITSY | Designed by Just Meijer



SPECIFICATIONS:

- Polypropylene shell and fully upholstered models.
- Polypropylene shells consists of 30% recycled material.
- Five base options available: 4-leg, A-frame, swivel with glides, swivel with casters and wood legs.
- Swivel base models with glides feature self-return.
- 4-leg model offered with arms or armless.
- Arm finish will match leg finish unless specified otherwise.
- Wood legs feature black metal trim as standard. For alternate metal trim finishes, please specify "-LT01" after model number and add \$119 List per unit. Please note that 0199 Chrome and 0299 Polished Aluminum are not available on trim.
- Wood legs available in all standard and custom finishes on Beech.
- For custom wood finishes, please contact client services and add one-time upcharge of \$531 List per color per order.
- For Super Matte Sable Beech, premium wood finish upcharge applies. Refer to options section for pricing.
- 4-leg models stack up to 5 high standing or 10 with dolly, with or without arms, and feature 3/4" tube diameter.
- A-frame models stack up to 7 high standing or 8 with dolly.
- If cartoning is required for 4-leg or A-frame models, chairs are packaged in units of three (3). A \$20 List carton break charge will be applied for orders with only one or two chairs.
- Swivel base model with casters features non-tilt, height adjustable mechanism.
- 300 lb. weight capacity
- All dimensions are nominal.
- Refer to terms and conditions for general information regarding finishes, warranty, freight, complete condition of sales and more.

STANDARD METAL BASE FINISH COLORS:

- 0405 Charcoal Grey
- 0535 Metallic Silver
- 0199 Chrome (4-leg and A-frame bases only)
- 0299 Polished Aluminum (swivel bases only)
- 0630 Satin Black

PREMIUM METAL BASE FINISH COLORS:

- 0605 Matte Black
- 0705 Matte Cotton
- 0788 Glossy Cotton
- 0805 Oasis
- 0905 Mint
- 1005 Mercury
- 1105 Canary
- 1205 Stone
- 1305 Sage
- 1405 Ice Blue
- 1505 Clay

POLYPROPYLENE COLORS:









- 140 Oasis
- 141 Mint
- 142 Mercury
- 143 Canary
- 148 Raven
- 149 Stark
- 150 Stone

All shipments for this series will be blanket-wrapped as standard. For customers located in Territory 1 who require cartoning, a 5% upcharge will be added to each product. Please contact client services for additional information.

KITSY | Designed by Just Meijer

ORDERING REQUIREMENTS:

- Model number
- Poly color
- Base/leg finish
- Wood leg metal trim finish, as applicable
- Options, as applicable

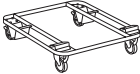
| MODEL | PRODUCT SPECIFICATIONS | LIST |
|--|--|------|
| 6811  |  Polypropylene Shell, 4-Leg Base, Armless 21" W x 21.5" D x 31.75" H Seat: 18.5" W x 16" D Seat Ht: 17.75" 13 lbs. | 585 |
| 6812  |  Polypropylene Shell, 4-Leg Base, Arms 21" W x 21.5" D x 31.75" H Seat: 18.5" W x 16" D Seat Ht: 17.75" Arm Ht: 26.25" 17 lbs. | 635 |
| 6813  |  Polypropylene Shell, A-Frame Base, Armless 20.5" W x 22.25" D x 31.25" H Seat: 18.5" W x 16" D Seat Ht: 17.25" 15 lbs. | 709 |
| 6814  |  Polypropylene Shell, Wood Legs, Armless 19.5" W x 22" D x 31.75" H Seat: 18.5" W x 16" D Seat Ht: 17.75" 14 lbs. | 922 |
| 6800  | Dolly (Black Finish Only) 24" W x 30" D x 6" H 37 lbs. | 657 |

OPTIONS

| | | |
|--------|--------------------------------------|-------|
| -PFM02 | Premium Metal Base/Leg Finish | \$101 |
| -PFW02 | Premium Wood Leg Finish | \$23 |
| -NSO4 | Non-Skid Glides | \$26 |
| -LT01 | Alternate Wood Leg Metal Trim Finish | \$119 |





 = Available on quick-ship program (0535 Metallic Silver, 0199 Chrome and standard wood base finishes only).

All shipments for this series will be blanket-wrapped as standard. For customers located in Territory 1 who require cartoning, a 5% upcharge will be added to each product. Please contact client services for additional information.

KITSY | Designed by Just Meijer

ORDERING REQUIREMENTS:

- Model number
- Poly color
- Base finish
- Options, as applicable

| MODEL | PRODUCT SPECIFICATIONS | LIST |
|---|---|------|
| 6815  |  Polypropylene Shell, Non-Tilt Swivel Base, Glides 20.5" W x 22.25" D x 31.25" H Seat: 18.5" W x 16" D Seat Ht: 17.75" 18 lbs. | 972 |
| 6816  |  Polypropylene Shell, Non-Tilt Swivel Base, Casters 20.5" W x 22.25" D x 31.25" - 34.25" H Seat: 18.5" W x 16" D Seat Ht: 17.75" - 20.75" 18 lbs. | 972 |

OPTIONS

| | | |
|---------|---------------------------------|-------|
| -PFM02 | Premium Metal Base Finish | \$101 |
| -STC02 | Soft Tread Casters | \$33 |
| -STLC02 | Soft Tread Self-Locking Casters | \$63 |









 = Available on quick-ship program (0535 Metallic Silver, 0299 Polished Aluminum base finishes only).

All shipments for this series will be blanket-wrapped as standard. For customers located in Territory 1 who require cartoning, a 5% upcharge will be added to each product. Please contact client services for additional information.

KITSY | Designed by Just Meijer

ORDERING REQUIREMENTS:

- Model number
- Base/leg finish
- Wood leg metal trim finish, as applicable
- Upholstery selection
- Options, as applicable

| MODEL | PRODUCT SPECIFICATIONS | FABRIC GRADES | | | | | | | | LEATHER | | | |
|--|--|---------------|-------|-------|-------|-------|-------|----------|-------|---------|-------|-------|-------|
| | | COM | A | 1 | 2 | 3 | 4 | COL 5 | 6 | 7 | 8 | L1 | L2 |
| 6811-U  |  Fully Upholstered, 4-Leg Base, Armless 21" W x 21.5" D x 31.75" H Seat: 18.5" W x 16" D Seat Ht: 18.25" COM: 1.25 yds. COL: 25 sq. ft. 13 lbs. | 896 | 981 | 1,026 | 1,054 | 1,098 | 1,145 | 1,188 | 1,231 | 1,275 | 1,320 | 1,526 | 1,676 |
| 6812-U  |  Fully Upholstered, 4-Leg Base, Arms 21" W x 21.5" D x 31.75" H Seat: 18.5" W x 16" D Seat Ht: 18.25" Arm Ht: 26.25" COM: 1.25 yds. COL: 25 sq. ft. 17 lbs. | 946 | 1,031 | 1,076 | 1,104 | 1,148 | 1,195 | 1,238 | 1,281 | 1,325 | 1,370 | 1,576 | 1,726 |
| 6813-U  |  Fully Upholstered, A-Frame Base, Armless 20.5" W x 22.25" D x 31.25" H Seat: 18.5" W x 16" D Seat Ht: 17.75" COM: 1.25 yds. COL: 25 sq. ft. 15 lbs. | 1,020 | 1,105 | 1,150 | 1,178 | 1,222 | 1,269 | 1,312 | 1,355 | 1,399 | 1,444 | 1,650 | 1,800 |
| 6814-U  |  Fully Upholstered, Wood Legs, Armless 19.5" W x 22" D x 31.75" H Seat: 18.5" W x 16" D Seat Ht: 18.25" COM: 1.25 yds. COL: 25 sq. ft. 14 lbs. | 1,233 | 1,318 | 1,363 | 1,391 | 1,435 | 1,482 | 1,525 | 1,568 | 1,612 | 1,657 | 1,863 | 2,013 |

OPTIONS

| | | |
|--------|--------------------------------------|-------|
| -PFM02 | Premium Metal Base/Leg Finish | \$101 |
| -PFW02 | Premium Wood Leg Finish | \$23 |
| -NSO4 | Non-Skid Glides | \$26 |
| -LT01 | Alternate Wood Leg Metal Trim Finish | \$119 |





 = Available on quick-ship program (0535 Metallic Silver, 0199 Chrome and standard wood base finishes only).

All shipments for this series will be blanket-wrapped as standard. For customers located in Territory 1 who require cartoning, a 5% upcharge will be added to each product. Please contact client services for additional information.

KITSY | Designed by Just Meijer

ORDERING REQUIREMENTS:

- Model number
- Base finish
- Upholstery selection
- Options, as applicable

| MODEL | PRODUCT SPECIFICATIONS | FABRIC GRADES | | | | | | | | | | LEATHER | |
|---|---|---------------|-------|-------|-------|-------|-------|----------|-------|-------|-------|---------|-------|
| | | COM | A | 1 | 2 | 3 | 4 | COL 5 | 6 | 7 | 8 | L1 | L2 |
| 6815-U  |  Fully Upholstered, Non-Tilt Swivel Base, Glides 20.5" W x 22.25" D x 31.25" H Seat: 18.5" W x 16" D Seat Ht: 17.75" COM: 1.25 yds. COL: 25 sq. ft. 18 lbs. | 1,283 | 1,368 | 1,413 | 1,441 | 1,485 | 1,532 | 1,575 | 1,618 | 1,662 | 1,707 | 1,913 | 2,063 |
| 6816-U  |  Fully Upholstered, Non-Tilt Swivel Base, Casters 20.5" W x 22.25" D x 31.25" - 34.25" H Seat: 18.5" W x 16" D Seat Ht: 17.75" - 20.75" COM: 1.25 yds. COL: 25 sq. ft. 18 lbs. | 1,283 | 1,368 | 1,413 | 1,441 | 1,485 | 1,532 | 1,575 | 1,618 | 1,662 | 1,707 | 1,913 | 2,063 |

OPTIONS

| | | |
|---------|---------------------------------|-------|
| -PFM02 | Premium Metal Base Finish | \$101 |
| -STC02 | Soft Tread Casters | \$33 |
| -STLC02 | Soft Tread Self-Locking Casters | \$63 |

 = Available on quick-ship program (0535 Metallic Silver, 0299 Polished Aluminum base finishes only).

All shipments for this series will be blanket-wrapped as standard. For customers located in Territory 1 who require cartoning, a 5% upcharge will be added to each product. Please contact client services for additional information.

KUVI WORK LOUNGE | Designed by Chris & Jon Panichella



SPECIFICATIONS:

- Arm and armless models available with glides or casters.
- Arm caps available in Ash wood and black urethane.
- Wood arm caps available in all standard finishes on Ash.
- For Alabaster and Super Matte Sable Ash, premium wood finish upcharge applies. Refer to options section for pricing.
- For custom wood finishes, please add \$531 List per color per order.
- Frame also functions as a handle for mobility ease.
- Mobile lounge chairs feature two locking casters in rear and two non-locking casters in front.
- Casters feature semi-soft treads for compatibility on all floor surfaces.
- Tubular steel frame.
- 350 lb. weight capacity.
- All dimensions are nominal.
- Refer to terms and conditions for general information regarding fabrics, finishes, warranty, freight, complete condition of sales and more.

ROTATING TABLET:

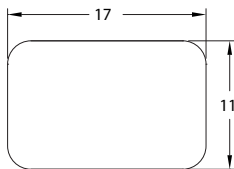

- Affixed to right or left arm, as specified.
- Tablet size is 17" W x 11" D x .75" thick and features 360-degree turning radius.
- Available in Ash and laminate surface options.
- For Alabaster and Super Matte Sable Ash, premium wood finish upcharge applies. Refer to options section for pricing.
- For custom wood finishes, please contact client services and add one-time upcharge of \$531 List per color per order.
- For custom laminate options, add \$649 List per color per order. Pre-approval required, please contact client services.
- For standard wood grain laminate or solid black laminate tops, edge will match unless specified otherwise.
- For all other solid laminates, edge will be exposed plywood substrate with clear coat finish.
- 100 lb. weight capacity.

KUVI WORK LOUNGE | Designed by Chris & Jon Panichella

UNDER-SEAT SHELF:

- Available on caster models only.
- Dimensions: 24" W x 21" D.
- Surface finish options include ash veneer as well as laminate selections.
- For Alabaster and Super Matte Sable Ash, premium wood finish upcharge applies. Refer to options section for pricing.
- Under-seat shelf features .5" tall guard rail.
- Guardrail will match frame finish unless otherwise specified.

SIDE TABLE:

- Measures 14" W x 8" D x .75" thick.
- Available in Ash and laminate surface options.
- For Alabaster and Super Matte Sable Ash, premium wood finish upcharge applies. Refer to options section for pricing.
- Optional cup holder available, with Clear Anodized Aluminum finish as standard.
- Black cup holder also offered at no upcharge. Please specify.
- Cupholder dimensions: 4" outer diameter, 3.25" inner diameter (cup size) x 3" deep.

STANDARD METAL FRAME FINISH COLORS:

- 0405 Charcoal Grey
- 0535 Metallic Silver
- 0630 Satin Black

PREMIUM METAL FRAME FINISH COLORS:





- 0605 Matte Black
- 0705 Matte Cotton
- 0788 Glossy Cotton
- 0805 Oasis
- 0905 Mint
- 1005 Mercury
- 1105 Canary
- 1205 Stone
- 1305 Sage
- 1405 Ice Blue
- 1505 Clay

All shipments for this series will be blanket-wrapped as standard. For customers located in Territory 1 who require cartoning, a 5% upcharge will be added to each product. Please contact client services for additional information.

KUVI WORK LOUNGE | Designed by Chris & Jon Panichella

ORDERING REQUIREMENTS:

- Model number
- Arm cap finish, as applicable
- Tablet and/or side table finish, as applicable
- Frame finish
- Upholstery selection
- Options, as applicable

| MODEL | PRODUCT SPECIFICATIONS | FABRIC GRADES | | | | | | | | LEATHER | | | |
|---|--|---------------------------------|-------|-------|-------|-------|-------|----------|-------|---------|-------|-------|-------|
| | | COM | A | 1 | 2 | 3 | 4 | COL 5 | 6 | 7 | 8 | L1 | L2 |
| 1210-NA-NA  | Lounge Chair, Armless, Glides 25" W x 29.25" D x 31.5" H Seat: 22.5" W x 19" D Seat Ht: 17" COM: 2.25 yds. COL: 45 sq. ft. 25 lbs. | 1,955 | 2,108 | 2,189 | 2,239 | 2,318 | 2,403 | 2,480 | 2,558 | 2,637 | 2,718 | 3,089 | 3,359 |
| 1210-AW-AW 1210-AU-AU  | Lounge Chair, Arms, Glides 26.5" W x 29.25" D x 31.5" H Seat: 22.5" W x 19" D Seat Ht: 17" COM: 2.25 yds. COL: 45 sq. ft. 29 lbs. | Arm Cap Wood (-AW) 2,321 | 2,474 | 2,555 | 2,605 | 2,684 | 2,769 | 2,846 | 2,924 | 3,003 | 3,084 | 3,455 | 3,725 |
| | | Arm Cap Urethane (-AU) 2,183 | 2,336 | 2,417 | 2,467 | 2,546 | 2,631 | 2,708 | 2,786 | 2,865 | 2,946 | 3,317 | 3,587 |
| 1210-TL-AW 1210-TL-AU  | Lounge Chair, Tablet Left, Arm Right, Glides 29" W x 29.25" D x 31.5" H Seat: 22.5" W x 19" D Seat Ht: 17" COM: 2.25 yds. COL: 45 sq. ft. 32 lbs. | Arm Cap Wood (-AW) 2,418 | 2,571 | 2,652 | 2,702 | 2,781 | 2,866 | 2,943 | 3,021 | 3,100 | 3,181 | 3,552 | 3,822 |
| | | Arm Cap Urethane (-AU) 2,349 | 2,502 | 2,583 | 2,633 | 2,712 | 2,797 | 2,874 | 2,952 | 3,031 | 3,112 | 3,483 | 3,753 |
| 1210-AW-TR 1210-AU-TR  | Lounge Chair, Arm Left, Tablet Right, Glides 29" W x 29.25" D x 31.5" H Seat: 22.5" W x 19" D Seat Ht: 17" COM: 2.25 yds. COL: 45 sq. ft. 32 lbs. | Arm Cap Wood (-AW) 2,418 | 2,571 | 2,652 | 2,702 | 2,781 | 2,866 | 2,943 | 3,021 | 3,100 | 3,181 | 3,552 | 3,822 |
| | | Arm Cap Urethane (-AU) 2,349 | 2,502 | 2,583 | 2,633 | 2,712 | 2,797 | 2,874 | 2,952 | 3,031 | 3,112 | 3,483 | 3,753 |

OPTIONS





| | | |
|--------|---|-------|
| -PFM02 | Premium Metal Finish | \$101 |
| -PFW01 | Premium Wood Finish (per arm/tablet/side table) | \$12 |
| -CL | Clean-Out Feature | \$92 |

All shipments for this series will be blanket-wrapped as standard. For customers located in Territory 1 who require cartoning, a 5% upcharge will be added to each product. Please contact client services for additional information.

KUVI WORK LOUNGE | Designed by Chris & Jon Panichella

ORDERING REQUIREMENTS:

- Model number
- Arm cap finish, as applicable
- Tablet and/or side table finish, as applicable
- Frame finish
- Upholstery selection
- Options, as applicable

| MODEL | PRODUCT SPECIFICATIONS | FABRIC GRADES | | | | | | | | LEATHER | | |
|--|---------------------------------|---------------|-------|-------|-------|-------|-------|----------|-------|---------|-------|-------|
| | | COM | A | 1 | 2 | 3 | 4 | COL 5 | 6 | 7 | 8 | L1 |
|  <p>1210-SL-TR Lounge Chair, Side Table Left, Tablet Right, Glides 34.75" W x 29.25" D x 31.5" H Seat: 22.5" W x 19" D Seat Ht: 17" COM: 2.25 yds. COL: 45 sq. ft. 33 lbs.</p> | 2,423 | 2,576 | 2,657 | 2,707 | 2,786 | 2,871 | 2,948 | 3,026 | 3,105 | 3,186 | 3,557 | 3,827 |
|  <p>1210-TL-SR Lounge Chair, Tablet Left, Side Table Right, Glides 34.75" W x 29.25" D x 31.5" H Seat: 22.5" W x 19" D Seat Ht: 17" COM: 2.25 yds. COL: 45 sq. ft. 33 lbs.</p> | 2,423 | 2,576 | 2,657 | 2,707 | 2,786 | 2,871 | 2,948 | 3,026 | 3,105 | 3,186 | 3,557 | 3,827 |
|  <p>1210-SL-AW 1210-SL-AU Lounge Chair, Side Table Left, Arm Right, Glides 32.25" W x 29.25" D x 31.5" H Seat: 22.5" W x 19" D Seat Ht: 17" COM: 2.25 yds. COL: 45 sq. ft. 30 lbs.</p> | Arm Cap Wood (-AW) 2,326 | 2,479 | 2,560 | 2,610 | 2,689 | 2,774 | 2,851 | 2,929 | 3,008 | 3,089 | 3,460 | 3,730 |
| | Arm Cap Urethane (-AU) 2,257 | 2,410 | 2,491 | 2,541 | 2,620 | 2,705 | 2,782 | 2,860 | 2,939 | 3,020 | 3,391 | 3,661 |
|  <p>1210-AW-SR 1210-AU-SR Lounge Chair, Arm Left, Side Table Right, Glides 32.25" W x 29.25" D x 31.5" H Seat: 22.5" W x 19" D Seat Ht: 17" COM: 2.25 yds. COL: 45 sq. ft. 30 lbs.</p> | Arm Cap Wood (-AW) 2,326 | 2,479 | 2,560 | 2,610 | 2,689 | 2,774 | 2,851 | 2,929 | 3,008 | 3,089 | 3,460 | 3,730 |
| | Arm Cap Urethane (-AU) 2,257 | 2,410 | 2,491 | 2,541 | 2,620 | 2,705 | 2,782 | 2,860 | 2,939 | 3,020 | 3,391 | 3,661 |

OPTIONS





| | | |
|--------|---|-------|
| -PFM02 | Premium Metal Finish | \$101 |
| -PFW01 | Premium Wood Finish (per arm/tablet/side table) | \$12 |
| -CH01 | Cup Holder | \$142 |
| -CL | Clean-Out Feature | \$92 |

All shipments for this series will be blanket-wrapped as standard. For customers located in Territory 1 who require cartoning, a 5% upcharge will be added to each product. Please contact client services for additional information.

KUVI WORK LOUNGE | Designed by Chris & Jon Panichella

ORDERING REQUIREMENTS:

- Model number
- Arm cap finish, as applicable
- Tablet and/or side table finish, as applicable
- Frame finish
- Upholstery selection
- Options, as applicable

| MODEL | PRODUCT SPECIFICATIONS | FABRIC GRADES | | | | | | | | LEATHER | | |
|---|------------------------|---------------|-------|-------|-------|-------|-------|----------|-------|---------|-------|-------|
| | | COM | A | 1 | 2 | 3 | 4 | COL 5 | 6 | 7 | 8 | L1 |
|  <p>1210-TL-NA Lounge Chair, Tablet Left, Glides 28.25" W x 29.25" D x X31.5" H Seat: 22.5" W x 19" D Seat Ht: 17" COM: 2.25 yds. COL: 45 sq. ft. 29 lbs.</p> | 2,235 | 2,388 | 2,469 | 2,519 | 2,598 | 2,683 | 2,760 | 2,838 | 2,917 | 2,998 | 3,369 | 3,639 |
|  <p>1210-NA-TR Lounge Chair, Tablet Right, Glides 28.25" W x 29.25" D x X31.5" H Seat: 22.5" W x 19" D Seat Ht: 17" COM: 2.25 yds. COL: 45 sq. ft. 29 lbs.</p> | 2,235 | 2,388 | 2,469 | 2,519 | 2,598 | 2,683 | 2,760 | 2,838 | 2,917 | 2,998 | 3,369 | 3,639 |
|  <p>1210-SL-NA Lounge Chair, Side Table Left, Glides 31.5" W x 29.25" D x X31.5" H Seat: 22.5" W x 19" D Seat Ht: 17" COM: 2.25 yds. COL: 45 sq. ft. 27 lbs.</p> | 2,143 | 2,296 | 2,377 | 2,427 | 2,506 | 2,591 | 2,668 | 2,746 | 2,825 | 2,906 | 3,277 | 3,547 |
|  <p>1210-NA-SR Lounge Chair, Side Table Right, Glides 31.5" W x 29.25" D x X31.5" H Seat: 22.5" W x 19" D Seat Ht: 17" COM: 2.25 yds. COL: 45 sq. ft. 27 lbs.</p> | 2,143 | 2,296 | 2,377 | 2,427 | 2,506 | 2,591 | 2,668 | 2,746 | 2,825 | 2,906 | 3,277 | 3,547 |

OPTIONS





| | | |
|--------|---|-------|
| -PFM02 | Premium Metal Finish | \$101 |
| -PFW01 | Premium Wood Finish (tablet/side table) | \$12 |
| -CH01 | Cup Holder (side table models only) | \$142 |
| -CL | Clean-Out Feature | \$92 |

All shipments for this series will be blanket-wrapped as standard. For customers located in Territory 1 who require cartoning, a 5% upcharge will be added to each product. Please contact client services for additional information.

KUVI WORK LOUNGE | Designed by Chris & Jon Panichella

ORDERING REQUIREMENTS:

- Model number
- Arm cap finish, as applicable
- Tablet and/or side table finish, as applicable
- Frame finish
- Upholstery selection
- Options, as applicable

| MODEL | PRODUCT SPECIFICATIONS | FABRIC GRADES | | | | | | | | LEATHER | | | |
|---|--|------------------------------------|-------|-------|-------|-------|-------|----------|-------|---------|-------|-------|-------|
| | | COM | A | 1 | 2 | 3 | 4 | COL 5 | 6 | 7 | 8 | L1 | L2 |
| 1250-NA-NA  | Lounge Chair, Armless, Casters 26" W x 29.25" D x 32.25" H Seat: 22.5" W x 19" D Seat Ht: 17.75" COM: 2.25 yds. COL: 45 sq. ft. 26 lbs. | 2,036 | 2,189 | 2,270 | 2,320 | 2,399 | 2,484 | 2,561 | 2,639 | 2,718 | 2,799 | 3,170 | 3,440 |
| 1250-AW-AW 1250-AU-AU  | Lounge Chair, Arms, Casters 26.5" W x 29.25" D x 32.25" H Seat: 22.5" W x 19" D Seat Ht: 17.75" COM: 2.25 yds. COL: 45 sq. ft. 30 lbs. | Arm Cap Wood (-AW) 2,402 | 2,555 | 2,636 | 2,686 | 2,765 | 2,850 | 2,927 | 3,005 | 3,084 | 3,165 | 3,536 | 3,806 |
| | | Arm Cap Urethane (-AU) 2,264 | 2,417 | 2,498 | 2,548 | 2,627 | 2,712 | 2,789 | 2,867 | 2,946 | 3,027 | 3,398 | 3,668 |
| 1250-TL-AW 1250-TL-AU  | Lounge Chair, Tablet Left, Arm Right, Casters 29" W x 29.25" D x 32.25" H Seat: 22.5" W x 19" D Seat Ht: 17.75" COM: 2.25 yds. COL: 45 sq. ft. 33 lbs. | Arm Cap Wood (-AW) 2,499 | 2,652 | 2,733 | 2,783 | 2,862 | 2,947 | 3,024 | 3,102 | 3,181 | 3,262 | 3,633 | 3,903 |
| | | Arm Cap Urethane (-AU) 2,430 | 2,583 | 2,664 | 2,714 | 2,793 | 2,878 | 2,955 | 3,033 | 3,112 | 3,193 | 3,564 | 3,834 |
| 1250-AW-TR 1250-AU-TR  | Lounge Chair, Arm Left, Tablet Right, Casters 29" W x 29.25" D x 32.25" H Seat: 22.5" W x 19" D Seat Ht: 17.75" COM: 2.25 yds. COL: 45 sq. ft. 33 lbs. | Arm Cap Wood (-AW) 2,499 | 2,652 | 2,733 | 2,783 | 2,862 | 2,947 | 3,024 | 3,102 | 3,181 | 3,262 | 3,633 | 3,903 |
| | | Arm Cap Urethane (-AU) 2,430 | 2,583 | 2,664 | 2,714 | 2,793 | 2,878 | 2,955 | 3,033 | 3,112 | 3,193 | 3,564 | 3,834 |

OPTIONS





| | | |
|--------------|--|-------|
| -PFM02 | Premium Metal Finish | \$101 |
| -PFW01 | Premium Wood Finish (per arm/tablet) | \$12 |
| -USS01 | Under-Seat Shelf | \$368 |
| -USS01-PFW02 | Under-Seat Shelf - Premium Wood Finish | \$373 |
| -CL | Clean-Out Feature | \$92 |

All shipments for this series will be blanket-wrapped as standard. For customers located in Territory 1 who require cartoning, a 5% upcharge will be added to each product. Please contact client services for additional information.

KUVI WORK LOUNGE | Designed by Chris & Jon Panichella

ORDERING REQUIREMENTS:

- Model number
- Arm cap finish, as applicable
- Tablet and/or side table finish, as applicable
- Frame finish
- Upholstery selection
- Options, as applicable

| MODEL | PRODUCT SPECIFICATIONS | FABRIC GRADES | | | | | | | | LEATHER | | |
|---|--|---------------|-------|-------|-------|-------|-------|-------|-------|---------|-------|-------|
| | | COM | A | 1 | 2 | 3 | 4 | COL 5 | 6 | 7 | 8 | L1 |
|  <p>1250-SL-TR Lounge Chair, Side Table Left, Tablet Right, Casters 34.75" W x 29.25" D x 32.25" H Seat: 22.5" W x 19" D Seat Ht: 18.5" COM: 2.25 yds. COL: 45 sq. ft. 34 lbs.</p> | 2,504 | 2,657 | 2,738 | 2,788 | 2,867 | 2,952 | 3,029 | 3,107 | 3,186 | 3,267 | 3,638 | 3,908 |
|  <p>1250-TL-SR Lounge Chair, Tablet Left, Side Table Right, Casters 34.75" W x 29.25" D x 32.25" H Seat: 22.5" W x 19" D Seat Ht: 18.5" COM: 2.25 yds. COL: 45 sq. ft. 34 lbs.</p> | 2,504 | 2,657 | 2,738 | 2,788 | 2,867 | 2,952 | 3,029 | 3,107 | 3,186 | 3,267 | 3,638 | 3,908 |
|  <p>1250-SL-AW 1250-SL-AU Lounge Chair, Side Table Left, Arm Right, Casters 32.25" W x 29.25" D x 32.25" H Seat: 22.5" W x 19" D Seat Ht: 17.75" COM: 2.25 yds. COL: 45 sq. ft. 31 lbs.</p> | Arm Cap Wood (-AW) 2,407 Arm Cap Urethane (-AU) 2,338 | 2,560 | 2,641 | 2,691 | 2,770 | 2,855 | 2,932 | 3,010 | 3,089 | 3,170 | 3,541 | 3,811 |
|  <p>1250-AW-SR 1250-AU-SR Lounge Chair, Arm Left, Side Table Right, Casters 32.25" W x 29.25" D x 32.25" H Seat: 22.5" W x 19" D Seat Ht: 17.75" COM: 2.25 yds. COL: 45 sq. ft. 31 lbs.</p> | Arm Cap Wood (-AW) 2,407 Arm Cap Urethane (-AU) 2,338 | 2,560 | 2,641 | 2,691 | 2,770 | 2,855 | 2,932 | 3,010 | 3,089 | 3,170 | 3,541 | 3,811 |

OPTIONS





| | | |
|--------------|---|-------|
| -PFM02 | Premium Metal Finish | \$101 |
| -PFW01 | Premium Wood Finish (per arm/tablet/side table) | \$12 |
| -CH01 | Cup Holder | \$142 |
| -USS01 | Under-Seat Shelf | \$368 |
| -USS01-PFW02 | Under-Seat Shelf - Premium Wood Finish | \$373 |
| -CL | Clean-Out Feature | \$92 |

All shipments for this series will be blanket-wrapped as standard. For customers located in Territory 1 who require cartoning, a 5% upcharge will be added to each product. Please contact client services for additional information.

KUVI WORK LOUNGE | Designed by Chris & Jon Panichella

ORDERING REQUIREMENTS:

- Model number
- Arm cap finish, as applicable
- Tablet and/or side table finish, as applicable
- Frame finish
- Upholstery selection
- Options, as applicable

| MODEL | PRODUCT SPECIFICATIONS | FABRIC GRADES | | | | | | | | LEATHER | | |
|--|------------------------|---------------|-------|-------|-------|-------|-------|----------|-------|---------|-------|-------|
| | | COM | A | 1 | 2 | 3 | 4 | COL 5 | 6 | 7 | 8 | L1 |
|  <p>1250-TL-NA Lounge Chair, Tablet Left, Casters 28.25" W x 29.25" D x 32.25" H Seat: 22.5" W x 19" D Seat Ht: 17.75" COM: 2.25 yds. COL: 45 sq. ft. 30 lbs.</p> | 2,316 | 2,469 | 2,550 | 2,600 | 2,679 | 2,764 | 2,841 | 2,919 | 2,998 | 3,079 | 3,450 | 3,720 |
|  <p>1250-NA-TR Lounge Chair, Tablet Right, Casters 28.25" W x 29.25" D x 32.25" H Seat: 22.5" W x 19" D Seat Ht: 17.75" COM: 2.25 yds. COL: 45 sq. ft. 30 lbs.</p> | 2,316 | 2,469 | 2,550 | 2,600 | 2,679 | 2,764 | 2,841 | 2,919 | 2,998 | 3,079 | 3,450 | 3,720 |
|  <p>1250-SL-NA Lounge Chair, Side Table Left, Casters 31.5" W x 29.25" D x 32.25" H Seat: 22.5" W x 19" D Seat Ht: 17.75" COM: 2.25 yds. COL: 45 sq. ft. 28 lbs.</p> | 2,224 | 2,377 | 2,458 | 2,508 | 2,587 | 2,672 | 2,749 | 2,827 | 2,906 | 2,987 | 3,358 | 3,628 |
|  <p>1250-NA-SR Lounge Chair, Side Table Right, Casters 31.5" W x 29.25" D x 32.25" H Seat: 22.5" W x 19" D Seat Ht: 17.75" COM: 2.25 yds. COL: 45 sq. ft. 28 lbs.</p> | 2,224 | 2,377 | 2,458 | 2,508 | 2,587 | 2,672 | 2,749 | 2,827 | 2,906 | 2,987 | 3,358 | 3,628 |

OPTIONS

| | | |
|--------------|---|-------|
| -PFM02 | Premium Metal Finish | \$101 |
| -PFW01 | Premium Wood Finish (tablet/side table) | \$12 |
| -CH01 | Cup Holder | \$142 |
| -USS01 | Under-Seat Shelf | \$368 |
| -USS01-PFW02 | Under-Seat Shelf - Premium Wood Finish | \$373 |
| -CL | Clean-Out Feature | \$92 |

All shipments for this series will be blanket-wrapped as standard. For customers located in Territory 1 who require cartoning, a 5% upcharge will be added to each product. Please contact client services for additional information.

KUVI WORK LOUNGE | Designed by Chris & Jon Panichella

UPHOLSTERY COMBINATIONS:

- For upholstery combinations, refer to the pricing below.
- When combining two COM/COV/COL fabrics, or fabrics with the same grade, add \$120 List per unit.
- When combining three or more COM/COV/COL fabrics, or fabrics with the same grade, add \$150 List per unit.
- When combining different grades of fabric, price will be based on the highest grade specified.
- Two-tone upholstery examples and yardage requirements for the most common combinations are listed below. Additional combinations available; please contact client services for yardage requirements and pricing.
- Note: Yardage amounts are based on fabric which is plain (i.e. non-directional) and a full 54" wide.
- Appropriate upholstery code must be included.



| | |
|--------------|----------------------------------|
| Code | KV1 |
| <u>Model</u> | <u>COM Requirement</u> |
| All Models | Seat = 1 yd. Back = 1.25 yds. |

All shipments for this series will be blanket-wrapped as standard. For customers located in Territory 1 who require cartoning, a 5% upcharge will be added to each product. Please contact client services for additional information.

LOUPE OCCASIONAL TABLES | Designed by Aaron Duke



SPECIFICATIONS:

- Round occasional tables with upholstered sides available in 3 diameters: 22", 30" and 36".
- Three top surface options: wood veneer, laminate and solid surface.
- Tops are ½" thick.
- Wood veneer available in all standard and custom finishes on walnut and white oak.
- For Alabaster and Super Matte Sable White Oak, premium wood finish upcharge applies. Refer to options section for pricing.
- For standard wood grain laminate or solid black laminate tops, edge will match the top color unless specified otherwise.
- For all other solid laminates, edge will be exposed plywood substrate with clear coat finish.
- Solid wood base with painted finish.
- Base offered in standard and premium colors. Please refer to listing below.
- All dimensions are nominal.
- Refer to terms and conditions for general information regarding fabrics, finishes, warranty, freight, complete condition of sales and more.

STANDARD BASE FINISH COLORS:

- 0405 Charcoal Grey
- 0535 Metallic Silver
- 0630 Satin Black

PREMIUM BASE FINISH COLORS:



- 0605 Matte Black
- 0705 Matte Cotton
- 0788 Glossy Cotton
- 0805 Oasis
- 0905 Mint
- 1005 Mercury
- 1105 Canary
- 1205 Stone
- 1305 Sage
- 1405 Ice Blue
- 1505 Clay

All shipments for this series will be blanket-wrapped as standard. For customers located in Territory 1 who require cartoning, a 5% upcharge will be added to each product. Please contact client services for additional information.

LOUPE OCCASIONAL TABLES | Designed by Aaron Duke

ORDERING REQUIREMENTS:

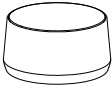
- Model number
- Top surface material
- Top finish
- Upholstery selection
- Base finish
- Options, as applicable

| MODEL | PRODUCT SPECIFICATIONS | TOP FINISH | FABRIC GRADES | | | | | | | | LEATHER | | | |
|---|--|---------------------|---------------|-------|-------|-------|-------|-------|-------|-------|---------|-------|-------|-------|
| | | | COM | A | 1 | 2 | 3 | 4 | COL 5 | 6 | 7 | 8 | L1 | L2 |
| 3620-2216-()  | 22" Round Table 22" Dia. x 16.5" H Table-Top Diameter: 19.25" COM: 1.25 yds. COL: 25 sq. ft. 36 lbs. | Veneer (-V) | 1,615 | 1,700 | 1,745 | 1,773 | 1,817 | 1,864 | 1,907 | 1,950 | 1,994 | 2,039 | 2,245 | 2,395 |
| | | Laminate (-L) | 1,466 | 1,551 | 1,596 | 1,624 | 1,668 | 1,715 | 1,758 | 1,801 | 1,845 | 1,890 | 2,096 | 2,246 |
| | | Solid Surface (-SF) | 1,745 | 1,830 | 1,875 | 1,903 | 1,947 | 1,994 | 2,037 | 2,080 | 2,124 | 2,169 | 2,375 | 2,525 |
| 3620-3016-()  | 30" Round Table 30" Dia. x 16.5" H Table-Top Diameter: 27.25" COM: 1.25 yds. COL: 25 sq. ft. 46 lbs. | Veneer (-V) | 2,277 | 2,362 | 2,407 | 2,435 | 2,479 | 2,526 | 2,569 | 2,612 | 2,656 | 2,701 | 2,907 | 3,057 |
| | | Laminate (-L) | 2,007 | 2,092 | 2,137 | 2,165 | 2,209 | 2,256 | 2,299 | 2,342 | 2,386 | 2,431 | 2,637 | 2,787 |
| | | Solid Surface (-SF) | 2,701 | 2,786 | 2,831 | 2,859 | 2,903 | 2,950 | 2,993 | 3,036 | 3,080 | 3,125 | 3,331 | 3,481 |
| 3620-3616-()  | 36" Round Table 36" Dia. x 16.5" H Table-Top Diameter: 33.25" COM: 2 yds. COL: 40 sq. ft. 57 lbs. | Veneer (-V) | 3,039 | 3,175 | 3,247 | 3,291 | 3,361 | 3,437 | 3,505 | 3,575 | 3,645 | 3,717 | 4,047 | 4,287 |
| | | Laminate (-L) | 2,562 | 2,698 | 2,770 | 2,814 | 2,884 | 2,960 | 3,028 | 3,098 | 3,168 | 3,240 | 3,570 | 3,810 |
| | | Solid Surface (-SF) | 3,561 | 3,697 | 3,769 | 3,813 | 3,883 | 3,959 | 4,027 | 4,097 | 4,167 | 4,239 | 4,569 | 4,809 |

OPTIONS

| | | |
|--------|-------------------------|-------|
| -PFM02 | Premium Base Finish | \$101 |
| -PFW02 | Premium Wood Top Finish | \$23 |

All shipments for this series will be cartoned as standard. If blanket-wrapped shipping is required, please contact client services for additional information.

LOUPE STOOLS | Designed by Aaron Duke



SPECIFICATIONS:

- 19" diameter stool available with directional or non-directional seat.
- Directional seat model comes standard with 360-degree swivel capability.
- Non-directional seat model offered with or without swivel capability.
- Grey reinforced nylon pull.
- Solid wood base with painted finish.
- All models come standard with nylon glides.
- 400 lb. weight capacity.
- All dimensions are nominal.
- Refer to terms and conditions for general information regarding fabrics, finishes, warranty, freight, complete condition of sales and more.

STANDARD BASE FINISH COLORS:

- 0405 Charcoal Grey
- 0535 Metallic Silver
- 0630 Satin Black

PREMIUM BASE FINISH COLORS:

- 0605 Matte Black
- 0705 Matte Cotton
- 0788 Glossy Cotton
- 0805 Oasis
- 0905 Mint
- 1005 Mercury
- 1105 Canary
- 1205 Stone
- 1305 Sage
- 1405 Ice Blue
- 1505 Clay

All shipments for this series will be cartoned as standard. If blanket-wrapped shipping is required, please contact client services for additional information.

LOUPE STOOLS | Designed by Aaron Duke

ORDERING REQUIREMENTS:

- Model number
- Upholstery selection
- Base finish
- Options, as applicable

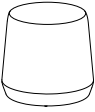
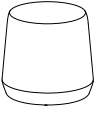
| MODEL | PRODUCT SPECIFICATIONS | FABRIC GRADES | | | | | | | | LEATHER | | | |
|--|--|---------------|-------|-------|-------|-------|-------|-------|-------|---------|-------|-------|-------|
| | | COM | A | 1 | 2 | 3 | 4 | COL 5 | 6 | 7 | 8 | L1 | L2 |
| 3610  | 19" Stool, Directional Seat, 360° Swivel 19" Dia. x 21" H Seat Diameter: 16" Seat Height: 18.75" COM: 1.25 yds. COL: 25 sq. ft. 31 lbs. | 1,530 | 1,615 | 1,660 | 1,688 | 1,732 | 1,779 | 1,822 | 1,865 | 1,909 | 1,954 | 2,160 | 2,310 |
| 3615  | 19" Stool, Non-Directional Seat 19" Dia. x 19" H Seat Diameter: 16" Seat Height: 18.5" COM: 1.25 yds. COL: 25 sq. ft. 26 lbs. | 1,189 | 1,274 | 1,319 | 1,347 | 1,391 | 1,438 | 1,481 | 1,524 | 1,568 | 1,613 | 1,819 | 1,969 |
| 3615-S  | 19" Stool, Non-Directional Seat, 360° Swivel 19" Dia. x 19" H Seat Diameter: 16" Seat Height: 18.5" COM: 1.25 yds. COL: 25 sq. ft. 31 lbs. | 1,260 | 1,345 | 1,390 | 1,418 | 1,462 | 1,509 | 1,552 | 1,595 | 1,639 | 1,684 | 1,890 | 2,040 |

OPTIONS

-PFM02 Premium Base Finish \$101

All shipments for this series will be cartoned as standard. If blanket-wrapped shipping is required, please contact client services for additional information.

LOUPE STOOLS | Designed by Aaron Duke

UPHOLSTERY COMBINATIONS:

- For upholstery combinations, refer to the pricing below.
- When combining two COM/COV/COL fabrics, or fabrics with the same grade, add \$120 List per unit.
- When combining different grades of fabric, price will be based on the highest grade specified.
- Two-tone upholstery examples and yardage requirements for the most common combinations are listed below. Additional combinations available; please contact client services for yardage requirements and pricing.
- Note: Yardage amounts are based on fabric which is plain (i.e. non-directional) and a full 54" wide.
- Appropriate upholstery code must be included.

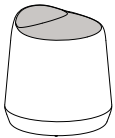

| Code | LU1 |
|--------------|---|
| <u>Model</u> | <u>COM Requirement</u> |
| 3610 | Top of Seat = .5 yd. Balance of Upholstery = 1 yd. |

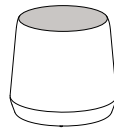

| Code | LU2 |
|--------------|-------------------------------|
| <u>Model</u> | <u>COM Requirement</u> |
| 3615 | Top of Seat = .5 yd. |
| 3616 | Balance of Upholstery = 1 yd. |

All shipments for this series will be blanket-wrapped as standard. For customers located in Territory 1 who require cartoning, a 5% upcharge will be added to each product. Please contact client services for additional information.

LUCENT® GUEST | Designed by Qdesign



SPECIFICATIONS:

- Passive-flex back.
- ¾" steel frame.
- Two frame finish options. Please refer to listing below.
- 300 lb. weight capacity.
- All dimensions are nominal.
- Refer to terms and conditions for general information regarding fabrics, finishes, warranty, freight, complete condition of sales and more.

STANDARD METAL FRAME FINISH COLORS:

- 0405 Charcoal Grey
- 0535 Metallic Silver

All shipments for this series will be blanket-wrapped as standard. For customers located in Territory 1 who require cartoning, a 5% upcharge will be added to each product. Please contact client services for additional information.

LUCENT® GUEST | Designed by Qdesign

ORDERING REQUIREMENTS:

- Model number
- Frame finish
- Upholstery selection

| MODEL | PRODUCT SPECIFICATIONS | FABRIC GRADES | | | | | | | | | | LEATHER | |
|--|--|---------------|-------|-------|-------|-------|-------|-------|-------|-------|-------|---------|-------|
| | | COM | A | 1 | 2 | 3 | 4 | 5 | 6 | 7 | 8 | L1 | L2 |
| 2910  | Guest Chair, Arms 24" W x 22.5" D x 33" H Seat: 18.5" W x 17.5" D Seat Ht: 18" Arm Ht: 25.5" COM: 1.25 yds. COL: 25 sq. ft. 20 lbs. | 1,456 | 1,541 | 1,586 | 1,614 | 1,658 | 1,705 | 1,748 | 1,791 | 1,835 | 1,880 | 2,086 | 2,236 |

All shipments for this series will be blanket-wrapped as standard. For customers located in Territory 1 who require cartoning, a 5% upcharge will be added to each product. Please contact client services for additional information.

MAYLAND GUEST | Designed by Gower + Woolf



SPECIFICATIONS:

- Available with Beech wood or metal frame.
- Metal frame available in standard and premium finishes. See below for options.
- For custom metal finish colors, please contact client services for pricing.
- Wood frame offered in all standard and custom finishes on Beech.
- For Super Matte Sable Beech, premium wood finish upcharge applies. Refer to options section for pricing.
- For custom wood finishes, please contact client services and add one-time upcharge of \$531 List per color per order.
- 300 lb. weight capacity.
- All dimensions are nominal.
- Refer to terms and conditions for general information regarding fabrics, finishes, warranty, freight, complete condition of sales and more.

STANDARD METAL FRAME FINISH COLORS:

- 0405 Charcoal Grey
- 0535 Metallic Silver
- 0630 Satin Black

PREMIUM METAL FRAME FINISH COLORS:



- 0605 Matte Black
- 0705 Matte Cotton
- 0788 Glossy Cotton
- 0805 Oasis
- 0905 Mint
- 1005 Mercury
- 1105 Canary
- 1205 Stone
- 1305 Sage
- 1405 Ice Blue
- 1505 Clay

All shipments for this series will be blanket-wrapped as standard. For customers located in Territory 1 who require cartoning, a 5% upcharge will be added to each product. Please contact client services for additional information.

MAYLAND GUEST | Designed by Gower + Woolf

ORDERING REQUIREMENTS:

- Model number
- Frame finish
- Upholstery selection
- Options, as applicable

| MODEL | PRODUCT SPECIFICATIONS | FABRIC GRADES | | | | | | | | LEATHER | | | |
|---|--|---------------|-------|-------|-------|-------|-------|----------|-------|---------|-------|-------|-------|
| | | COM | A | 1 | 2 | 3 | 4 | COL 5 | 6 | 7 | 8 | L1 | L2 |
| 5920  |  Guest Chair, Metal Frame 26" W x 27" D x 29.75" H Seat: 20" W x 18" D Seat Ht: 18" COM: 3 yds. COL: 60 sq. ft. 37 lbs. | 2,021 | 2,225 | 2,333 | 2,399 | 2,504 | 2,618 | 2,720 | 2,825 | 2,930 | 3,038 | 3,533 | 3,893 |
| 5920-W  | Guest Chair, Wood Frame 26.75" W x 27.5" D x 29.75" H Seat: 20" W x 18" D Seat Ht: 18" COM: 3 yds. COL: 60 sq. ft. 36 lbs. | 2,499 | 2,703 | 2,811 | 2,877 | 2,982 | 3,096 | 3,198 | 3,303 | 3,408 | 3,516 | 4,011 | 4,371 |

OPTIONS

| | | |
|--------|-----------------------------------|-------|
| -PFM02 | Premium Metal Frame Finish | \$101 |
| -PFW03 | Premium Wood Frame Finish | \$34 |
| -NS04 | Non-Skid Glides | \$26 |
| -VCT04 | VCT Tile Glides (model 5920 only) | \$28 |

 = Available on quick-ship program (standard metal base finishes only).

All shipments for this series will be blanket-wrapped as standard. For customers located in Territory 1 who require cartoning, a 5% upcharge will be added to each product. Please contact client services for additional information.

MAYLAND GUEST | Designed by Gower + Woolf

UPHOLSTERY COMBINATIONS:

- For upholstery combinations, refer to the pricing below.
- When combining two COM/COV/COL fabrics, or fabrics with the same grade, add \$120 List per unit.
- When combining three or more COM/COV/COL fabrics, or fabrics with the same grade, add \$150 List per unit.
- When combining different grades of fabric, price will be based on the highest grade specified.
- Two-tone upholstery examples and yardage requirements for the most common combinations are listed below. Additional combinations available; please contact client services for yardage requirements and pricing.
- Note: Yardage amounts are based on fabric which is plain (i.e. non-directional) and a full 54" wide.
- Appropriate upholstery code must be included.



| | |
|--------------|---|
| Code | MA1 |
| <u>Model</u> | <u>COM Requirement</u> |
| All | Back Cushion Only = .75 yd. Balance of Chair = 2.75 yds. |



| | |
|--------------|---|
| Code | MA2 |
| <u>Model</u> | <u>COM Requirement</u> |
| All | Seat Cushion Only = 1 yd. Balance of Chair = 2.75 yds. |



| | |
|--------------|---|
| Code | MA3 |
| <u>Model</u> | <u>COM Requirement</u> |
| All | Seat & Back Cushion = 1.25 yds. Balance of Chair = 2.25 yds. |

All shipments for this series will be blanket-wrapped as standard. For customers located in Territory 1 who require cartoning, a 5% upcharge will be added to each product. Please contact client services for additional information.

MAYLAND LOUNGE | Designed by Gower + Woolf



SPECIFICATIONS:

- Available with Beech wood or metal frame.
- Metal frame available in standard and premium finishes. See below for options.
- For custom metal finish colors, please contact client services for pricing.
- Wood frame offered in all standard and custom finishes on Beech.
- For Super Matte Sable Beech, premium wood finish upcharge applies. Refer to options section for pricing.
- For custom wood finishes, please contact client services and add one-time upcharge of \$531 List per color per order.
- 350 lb. weight capacity.
- All dimensions are nominal.
- Refer to terms and conditions for general information regarding fabrics, finishes, warranty, freight, complete condition of sales and more.

STANDARD METAL FRAME FINISH COLORS:

- 0405 Charcoal Grey
- 0535 Metallic Silver
- 0630 Satin Black

PREMIUM METAL FRAME FINISH COLORS:

- 0605 Matte Black
- 0705 Matte Cotton
- 0788 Glossy Cotton
- 0805 Oasis
- 0905 Mint
- 1005 Mercury
- 1105 Canary
- 1205 Stone
- 1305 Sage
- 1405 Ice Blue
- 1505 Clay

All shipments for this series will be blanket-wrapped as standard. For customers located in Territory 1 who require cartoning, a 5% upcharge will be added to each product. Please contact client services for additional information.

MAYLAND LOUNGE | Designed by Gower + Woolf

ORDERING REQUIREMENTS:

- Model number
- Frame finish
- Upholstery selection
- Options, as applicable

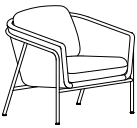
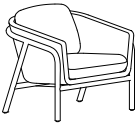
| MODEL | PRODUCT SPECIFICATIONS | FABRIC GRADES | | | | | | | | LEATHER | | | |
|---|--|---------------|-------|-------|-------|-------|-------|----------|-------|---------|-------|-------|-------|
| | | COM | A | 1 | 2 | 3 | 4 | COL 5 | 6 | 7 | 8 | L1 | L2 |
| 5901  | <p>🏷️ Lounge Chair, Metal Frame</p> <p>30.5" W x 30" D x 29.75" H Seat: 24" W x 19.5" D Seat Ht: 16.75" COM: 4 yds. COL: 80 sq. ft. 52 lbs.</p> | 2,424 | 2,696 | 2,840 | 2,928 | 3,068 | 3,220 | 3,356 | 3,496 | 3,636 | 3,780 | 4,440 | 4,920 |
| 5901-W  | <p>Lounge Chair, Wood Frame</p> <p>31.75" W x 31" D x 29.75" H Seat: 24" W x 19.5" D Seat Ht: 16.75" COM: 4 yds. COL: 80 sq. ft. 51 lbs.</p> | 2,976 | 3,248 | 3,392 | 3,480 | 3,620 | 3,772 | 3,908 | 4,048 | 4,188 | 4,332 | 4,992 | 5,472 |

OPTIONS

| | | |
|--------|-----------------------------------|-------|
| -PFM02 | Premium Metal Frame Finish | \$101 |
| -PFW03 | Premium Wood Frame Finish | \$34 |
| -NS04 | Non-Skid Glides | \$26 |
| -VCT04 | VCT Tile Glides (model 5901 only) | \$28 |

🏷️ = Available on quick-ship program (standard metal base finishes only).

All shipments for this series will be blanket-wrapped as standard. For customers located in Territory 1 who require cartoning, a 5% upcharge will be added to each product. Please contact client services for additional information.

MAYLAND LOUNGE | Designed by Gower + Woolf

UPHOLSTERY COMBINATIONS:

- For upholstery combinations, refer to the pricing below.
- When combining two COM/COV/COL fabrics, or fabrics with the same grade, add \$120 List per unit.
- When combining three or more COM/COV/COL fabrics, or fabrics with the same grade, add \$150 List per unit.
- When combining different grades of fabric, price will be based on the highest grade specified.
- Two-tone upholstery examples and yardage requirements for the most common combinations are listed below. Additional combinations available; please contact client services for yardage requirements and pricing.
- Note: Yardage amounts are based on fabric which is plain (i.e. non-directional) and a full 54" wide.
- Appropriate upholstery code must be included.



Code MY1

Model

All

COM Requirement

Back Cushion Only = .75 yd.

Balance of Chair = 3.5 yds.



Code MY2

Model

All

COM Requirement

Seat Cushion Only = 1 yd.

Balance of Chair = 3.25 yds.



Code MY3

Model

All

COM Requirement

Seat & Back Cushion = 2 yds.

Balance of Chair = 2.5 yds.

All shipments for this series will be blanket-wrapped as standard. For customers located in Territory 1 who require cartoning, a 5% upcharge will be added to each product. Please contact client services for additional information.

MELINA CONFERENCE/EXECUTIVE | Licensed from Wiesner Hager - Austria



SPECIFICATIONS:

- Mid- and high back models.
- Aluminum die-cast base.
- Metal bases offered in standard and premium finishes. Please refer to listing below.
- For custom metal finish colors, please contact client services for pricing.
- 300 lb. weight capacity.
- All dimensions are nominal.
- Swivel-tilt with tilt lock mechanism.
- Refer to terms and conditions for general information regarding fabrics, finishes, warranty, freight, complete condition of sales and more.

STANDARD METAL BASE FINISH COLORS:

- 0405 Charcoal Grey
- 0535 Metallic Silver
- 0299 Polished Aluminum
- 0630 Satin Black

PREMIUM METAL BASE FINISH COLORS:

- 0605 Matte Black
- 0705 Matte Cotton
- 0788 Glossy Cotton
- 0805 Oasis
- 0905 Mint
- 1005 Mercury
- 1105 Canary
- 1205 Stone
- 1305 Sage
- 1405 Ice Blue
- 1505 Clay





All shipments for this series will be blanket-wrapped as standard. For customers located in Territory 1 who require cartoning, a 5% upcharge will be added to each product. Please contact client services for additional information.

MELINA CONFERENCE/EXECUTIVE | Licensed from Wiesner Hager - Austria

Swivel-Tilt with Tilt Lock Mechanism

ORDERING REQUIREMENTS:

- Model number
- Base finish
- Upholstery selection
- Options, as applicable

| MODEL | PRODUCT SPECIFICATIONS | FABRIC GRADES | | | | | | | | | | LEATHER | |
|---|--|---------------|-------|-------|-------|-------|-------|----------|-------|-------|-------|---------|-------|
| | | COM | A | 1 | 2 | 3 | 4 | COL 5 | 6 | 7 | 8 | L1 | L2 |
| 5254-M  |  Mid-Back Conference/Executive Chair 27.5" W x 27" D x 33" - 36" H Seat: 16" W x 18" D Seat Ht: 17" - 20" COM: 2 yds. COL: 40 sq. ft. 22 lbs. | 1,815 | 1,951 | 2,023 | 2,067 | 2,137 | 2,213 | 2,281 | 2,351 | 2,421 | 2,493 | 2,823 | 3,063 |
| 5254-H  |  High Back Conference/Executive Chair 27.5" W x 29" D x 41" - 44" H Seat: 16" W x 18" D Seat Ht: 17" - 20" COM: 2.25 yds. COL: 45 sq. ft. 25 lbs. | 1,874 | 2,027 | 2,108 | 2,158 | 2,237 | 2,322 | 2,399 | 2,477 | 2,556 | 2,637 | 3,008 | 3,278 |

OPTIONS

| | | |
|---------|---------------------------------|-------|
| -PFM02 | Premium Metal Base Finish | \$101 |
| -STC02 | Soft Tread Casters | \$33 |
| -STLC02 | Soft Tread Self-Locking Casters | \$63 |
| -GDO4 | Glides | \$30 |
| -J01 | Jury Base (black only) | \$199 |

 = Available on quick-ship program (0299 Polished Aluminum base finish only).

MELINA CONFERENCE/EXECUTIVE | Licensed from Wiesner Hager - Austria

UPHOLSTERY COMBINATIONS:

- For upholstery combinations, refer to the pricing below.
- When combining two COM/COV/COL fabrics, or fabrics with the same grade, add \$120 List per unit.
- When combining three or more COM/COV/COL fabrics, or fabrics with the same grade, add \$150 List per unit.
- When combining different grades of fabric, price will be based on the highest grade specified.
- Two-tone upholstery examples and yardage requirements for the most common combinations are listed below. Additional combinations available; please contact client Services for yardage requirements and pricing.
- Note: Yardage amounts are based on fabric which is plain (i.e. non-directional) and a full 54" wide.
- Appropriate upholstery code must be included.



Code **ML1**
Model COM Requirement
5254-M Seat Cushion = 1 yd.
Balance of Chair = 1.5 yds.



Code **ML2**
Model COM Requirement
5254-H Seat Cushion = 1 yd.
Balance of Chair = 1.75 yds.



Code **ML3**
Model COM Requirement
5254-M Outside Back & Outside Arm Panel = 1 yd.
Balance of Chair = 1.5 yds.



Code **ML4**
Model COM Requirement
5254-H Outside Back & Outside Arm Panel = 1.25 yds.
Balance of Chair = 1.5 yds.

All shipments for this series will be blanket-wrapped as standard. For customers located in Territory 1 who require cartoning, a 5% upcharge will be added to each product. Please contact client services for additional information.

MELINA GUEST | Licensed from Wiesner Hager - Austria



SPECIFICATIONS:

- Four base options available: 4-leg metal, metal swivel, 4-leg wood and wood swivel.
- Swivel base models feature self-return.
- Metal bases offered in standard and premium finishes. Please refer to listing below.
- For custom metal finish colors, please contact client services for pricing.
- Wood bases offered in all standard and custom finishes on Ash.
- For custom wood finishes, please contact client services and add one-time upcharge of \$531 List per color per order.
- For Alabaster and Super Matte Sable Ash, premium wood finish upcharge applies. Refer to options section for pricing.
- 300 lb. weight capacity.
- All dimensions are nominal.
- Refer to terms and conditions for general information regarding fabrics, finishes, warranty, freight, complete condition of sales and more.

STANDARD METAL BASE FINISH COLORS:

- 0405 Charcoal Grey
- 0535 Metallic Silver
- 0199 Chrome (4-leg base only)
- 0299 Polished Aluminum (swivel base only)
- 0630 Satin Black

PREMIUM METAL BASE FINISH COLORS:







- 0605 Matte Black
- 0705 Matte Cotton
- 0788 Glossy Cotton
- 0805 Oasis
- 0905 Mint
- 1005 Mercury
- 1105 Canary
- 1205 Stone
- 1305 Sage
- 1405 Ice Blue
- 1505 Clay

All shipments for this series will be blanket-wrapped as standard. For customers located in Territory 1 who require cartoning, a 5% upcharge will be added to each product. Please contact client services for additional information.

MELINA GUEST | Licensed from Wiesner Hager - Austria

ORDERING REQUIREMENTS:

- Model number
- Base finish
- Upholstery selection
- Options, as applicable

| MODEL | PRODUCT SPECIFICATIONS | FABRIC GRADES | | | | | | | | | | LEATHER | |
|---|---|---------------|-------|-------|-------|-------|-------|----------|-------|-------|-------|---------|-------|
| | | COM | A | 1 | 2 | 3 | 4 | COL 5 | 6 | 7 | 8 | L1 | L2 |
| 52121  |  Guest Chair, 4-Leg Metal Base 27" W x 25.5" D x 33" H Seat: 16" W x 18" D Seat Ht: 18" COM: 2 yds. COL: 40 sq. ft. 22 lbs. | 1,498 | 1,634 | 1,706 | 1,750 | 1,820 | 1,896 | 1,964 | 2,034 | 2,104 | 2,176 | 2,506 | 2,746 |
| 52123  |  Guest Chair, Metal Swivel Base 27.5" W x 27.5" D x 33" H Seat: 16" W x 18" D Seat Ht: 18" COM: 2 yds. COL: 40 sq. ft. 18 lbs. | 1,712 | 1,848 | 1,920 | 1,964 | 2,034 | 2,110 | 2,178 | 2,248 | 2,318 | 2,390 | 2,720 | 2,960 |
| 52124  |  Guest Chair, 4-Leg Wood Base 27" W x 25.5" D x 33" H Seat: 16" W x 18" D Seat Ht: 18" COM: 2 yds. COL: 40 sq. ft. 17 lbs. | 1,694 | 1,830 | 1,902 | 1,946 | 2,016 | 2,092 | 2,160 | 2,230 | 2,300 | 2,372 | 2,702 | 2,942 |
| 52127  | Guest Chair, Wood Swivel Base 29.5" W x 29.5" D x 33" H Seat: 16" W x 18" D Seat Ht: 18" COM: 2 yds. COL: 40 sq. ft. 19 lbs. | 1,941 | 2,077 | 2,149 | 2,193 | 2,263 | 2,339 | 2,407 | 2,477 | 2,547 | 2,619 | 2,949 | 3,189 |

OPTIONS

| | | |
|--------|---------------------------|-------|
| -PFM02 | Premium Metal Base Finish | \$101 |
| -PFW02 | Premium Wood Base Finish | \$23 |
| -NSO4 | Non-Skid Glides | \$26 |

 = Available on quick-ship program (0535 Metallic Silver, 0199 Chrome, 0299 Polished Aluminum and standard wood base finishes only).

All shipments for this series will be blanket-wrapped as standard. For customers located in Territory 1 who require cartoning, a 5% upcharge will be added to each product. Please contact client services for additional information.

MELINA GUEST | Licensed from Wiesner Hager - Austria

UPHOLSTERY COMBINATIONS:

- For upholstery combinations, refer to the pricing below.
- When combining two COM/COV/COL fabrics, or fabrics with the same grade, add \$120 List per unit.
- When combining three or more COM/COV/COL fabrics, or fabrics with the same grade, add \$150 List per unit.
- When combining different grades of fabric, price will be based on the highest grade specified.
- Two-tone upholstery examples and yardage requirements for the most common combinations are listed below. Additional combinations available; please contact client Services for yardage requirements and pricing.
- Note: Yardage amounts are based on fabric which is plain (i.e. non-directional) and a full 54" wide.
- Appropriate upholstery code must be included.



| Code | ML1 |
|--------------|---|
| <u>Model</u> | <u>COM Requirement</u> |
| All | Seat Cushion = 1 yd. Balance of Chair = 1.5 yds. |



| Code | ML2 |
|--------------|---|
| <u>Model</u> | <u>COM Requirement</u> |
| All | Outside Back & Outside Arm Panel = 1 yd. Balance of Chair = 1.5 yds. |

All shipments for this series will be blanket-wrapped as standard. For customers located in Territory 1 who require cartoning, a 5% upcharge will be added to each product. Please contact client services for additional information.

MELINA LOUNGE | Licensed from Wiesner Hager - Austria



SPECIFICATIONS:

- Mid- and high back models.
- Three base options available: metal swivel, 4-leg wood and wood swivel.
- Swivel base models feature self-return.
- Metal swivel base offered in standard and premium finishes. Please refer to listing below.
- For custom metal finish colors, please contact client services for pricing.
- Wood bases offered in all standard and custom finishes on Ash.
- For custom wood finishes, please contact client services and add one-time upcharge of \$531 List per color per order.
- For Alabaster and Super Matte Sable Ash, premium wood finish upcharge applies. Refer to options section for pricing.
- 300 lb. weight capacity.
- All dimensions are nominal.
- Refer to terms and conditions for general information regarding fabrics, finishes, warranty, freight, complete condition of sales and more.

STANDARD METAL BASE FINISH COLORS:

- 0405 Charcoal Grey
- 0535 Metallic Silver
- 0299 Polished Aluminum
- 0630 Satin Black

PREMIUM METAL BASE FINISH COLORS:





- 0605 Matte Black
- 0705 Matte Cotton
- 0788 Glossy Cotton
- 0805 Oasis
- 0905 Mint
- 1005 Mercury
- 1105 Canary
- 1205 Stone
- 1305 Sage
- 1405 Ice Blue
- 1505 Clay

All shipments for this series will be blanket-wrapped as standard. For customers located in Territory 1 who require cartoning, a 5% upcharge will be added to each product. Please contact client services for additional information.

MELINA LOUNGE | Licensed from Wiesner Hager - Austria

ORDERING REQUIREMENTS:

- Model number
- Base finish
- Upholstery selection
- Options, as applicable

| MODEL | PRODUCT SPECIFICATIONS | FABRIC GRADES | | | | | | | | LEATHER | | | |
|---|--|---------------|-------|-------|-------|-------|-------|----------|-------|---------|-------|-------|-------|
| | | COM | A | 1 | 2 | 3 | 4 | COL 5 | 6 | 7 | 8 | L1 | L2 |
| 52223-M  |  Mid-Back Lounge Chair, Metal Swivel Base 28.5" W x 25.5" D x 31.5" H Seat: 18" W x 18" D Seat Ht: 16.75" COM: 2 yds. COL: 40 sq. ft. 25 lbs. | 1,866 | 2,002 | 2,074 | 2,118 | 2,188 | 2,264 | 2,332 | 2,402 | 2,472 | 2,544 | 2,874 | 3,114 |
| 52224-M  | Mid-Back Lounge Chair, 4-Leg Wood Base 31.5" W x 31.5" D x 31.5" H Seat: 18" W x 18" D Seat Ht: 16.75" COM: 2 yds. COL: 40 sq. ft. 26 lbs. | 1,726 | 1,862 | 1,934 | 1,978 | 2,048 | 2,124 | 2,192 | 2,262 | 2,332 | 2,404 | 2,734 | 2,974 |
| 52227-M  | Mid-Back Lounge Chair, Wood Swivel Base 29.5" W x 29.5" D x 31.5" H Seat: 18" W x 18" D Seat Ht: 16.75" COM: 2 yds. COL: 40 sq. ft. 27 lbs. | 1,992 | 2,128 | 2,200 | 2,244 | 2,314 | 2,390 | 2,458 | 2,528 | 2,598 | 2,670 | 3,000 | 3,240 |

OPTIONS

| | | |
|--------|---------------------------|-------|
| -PFM02 | Premium Metal Base Finish | \$101 |
| -PFW02 | Premium Wood Base Finish | \$23 |
| -NS04 | Non-Skid Glides | \$26 |





 = Available on quick-ship program (0535 Metallic Silver and 0299 Polished Aluminum base finishes only).

All shipments for this series will be blanket-wrapped as standard. For customers located in Territory 1 who require cartoning, a 5% upcharge will be added to each product. Please contact client services for additional information.

MELINA LOUNGE | Licensed from Wiesner Hager - Austria

ORDERING REQUIREMENTS:

- Model number
- Base finish
- Upholstery selection
- Options, as applicable

| MODEL | PRODUCT SPECIFICATIONS | FABRIC GRADES | | | | | | | | LEATHER | | | |
|---|---|---------------|-------|-------|-------|-------|-------|----------|-------|---------|-------|-------|-------|
| | | COM | A | 1 | 2 | 3 | 4 | COL 5 | 6 | 7 | 8 | L1 | L2 |
| 52223-H  |  High Back Lounge Chair, Metal Swivel Base 28.5" W x 25.75" D x 39.5" H Seat: 18" W x 18" D Seat Ht: 16.75" COM: 2.25 yds. COL: 45 sq. ft. 28 lbs. | 2,015 | 2,168 | 2,249 | 2,299 | 2,378 | 2,463 | 2,540 | 2,618 | 2,697 | 2,778 | 3,149 | 3,419 |
| 52224-H  | High Back Lounge Chair, 4-Leg Wood Base 31.5" W x 31.5" D x 39.5" H Seat: 18" W x 18" D Seat Ht: 16.75" COM: 2.25 yds. COL: 45 sq. ft. 29 lbs. | 1,873 | 2,026 | 2,107 | 2,157 | 2,236 | 2,321 | 2,398 | 2,476 | 2,555 | 2,636 | 3,007 | 3,277 |
| 52227-H  | High Back Lounge Chair, Wood Swivel Base 29.5" W x 29.5" D x 39.5" H Seat: 18" W x 18" D Seat Ht: 16.75" COM: 2.25 yds. COL: 45 sq. ft. 36 lbs. | 2,107 | 2,260 | 2,341 | 2,391 | 2,470 | 2,555 | 2,632 | 2,710 | 2,789 | 2,870 | 3,241 | 3,511 |

OPTIONS

| | | |
|--------|---------------------------|-------|
| -PFM02 | Premium Metal Base Finish | \$101 |
| -PFW02 | Premium Wood Base Finish | \$23 |
| -NSO4 | Non-Skid Glides | \$26 |

 = Available on quick-ship program (0535 Metallic Silver and 0299 Polished Aluminum base finishes only).

MELINA LOUNGE | Licensed from Wiesner Hager - Austria

UPHOLSTERY COMBINATIONS:

- For upholstery combinations, refer to the pricing below.
- When combining two COM/COV/COL fabrics, or fabrics with the same grade, add \$120 List per unit.
- When combining three or more COM/COV/COL fabrics, or fabrics with the same grade, add \$150 List per unit.
- When combining different grades of fabric, price will be based on the highest grade specified.
- Two-tone upholstery examples and yardage requirements for the most common combinations are listed below. Additional combinations available; please contact client Services for yardage requirements and pricing.
- Note: Yardage amounts are based on fabric which is plain (i.e. non-directional) and a full 54" wide.
- Appropriate upholstery code must be included.



| Code | ML1 |
|--------------|-----------------------------|
| <u>Model</u> | <u>COM Requirement</u> |
| 52223-M | Seat Cushion = 1 yd. |
| 52224-M | Balance of Chair = 1.5 yds. |
| 52227-M | |



| Code | ML2 |
|--------------|------------------------------|
| <u>Model</u> | <u>COM Requirement</u> |
| 52223-H | Seat Cushion = 1 yd. |
| 52224-H | Balance of Chair = 1.75 yds. |
| 52227-H | |



| Code | ML3 |
|--------------|--|
| <u>Model</u> | <u>COM Requirement</u> |
| 52223-M | Outside Back & Outside Arm Panel = 1 yd. |
| 52224-M | Balance of Chair = 1.5 yds. |
| 52227-M | |



| Code | ML4 |
|--------------|--|
| <u>Model</u> | <u>COM Requirement</u> |
| 52223-H | Outside Back & Outside Arm Panel = 1.25 yds. |
| 52224-H | Balance of Chair = 1.5 yds. |
| 52227-H | |

MELINA MEETING TABLES | Licensed from Wiesner Hager - Austria



SPECIFICATIONS:

- Round and square top shapes offered in 29" and 42" heights.
- Five table surface options: wood veneer, laminate, Fenix, solid surface or Starphire® glass.
- Wood veneer available in all standard and custom finishes on Ash.
- For custom wood finishes, please contact client services and add one-time upcharge of \$531 List per color per order.
- For Alabaster and Super Matte Sable Ash, premium wood finish upcharge applies. Refer to options section for pricing.
- For custom laminate options, add \$649 List per color per order. Pre-approval required, please contact client services.
- Fenix offered in five standard colorways.
- For non-standard Fenix colors, please contact client services for pricing.
- Solid surface available in white only.
- For veneer, standard wood grain and solid black laminate, as well as Fenix Nero Ingo (black), edge will match top finish color, unless specified otherwise.
- For all other finishes, edge will be exposed plywood with a clear coat finish as standard.
- Glass tops are back-painted white as standard.
- Back-painted glass and solid surface tops feature exposed plywood substrate edge with clear coat finish.
- Column and base offered in standard and premium metal finishes. Please refer to listing below.
- All dimensions are nominal.
- Refer to terms and conditions for general information regarding finishes, warranty, freight, complete condition of sales and more.

STANDARD METAL COLUMN/BASE FINISH COLORS:

- 0405 Charcoal Grey
- 0535 Metallic Silver
- 0299 Polished Aluminum
- 0630 Satin Black

PREMIUM METAL COLUMN/BASE FINISH COLORS:

- 0605 Matte Black
- 0705 Matte Cotton
- 0788 Glossy Cotton
- 0805 Oasis
- 0905 Mint
- 1005 Mercury
- 1105 Canary
- 1205 Stone
- 1305 Sage
- 1405 Ice Blue
- 1505 Clay

All shipments for this series will be blanket-wrapped as standard. For customers located in Territory 1 who require cartoning, a 5% upcharge will be added to each product. Please contact client services for additional information.

MELINA MEETING TABLES | Licensed from Wiesner Hager - Austria

POWER NODE UNIT:

- Available on all top surfaces excluding glass.
- Power Node is 3-3/8" in diameter and 72" electrical cord.
- Chrome and white color options.
- Unless specified otherwise, unit will be positioned in center of table-top.



Power Node (PNI):

- One outlet, one USB-A and one USB-C charging port.

EDGE DETAIL:

Laminate*/Veneer/Fenix Top



Exposed Plywood Edge

Glass Top



1/2" Exposed Plywood Substrate

Solid Surface Top



1/2" Plywood Substrate

*Please note that laminate thickness is nominal and may vary.

All shipments for this series will be blanket-wrapped as standard. For customers located in Territory 1 who require cartoning, a 5% upcharge will be added to each product. Please contact client services for additional information.

MELINA MEETING TABLES | Licensed from Wiesner Hager - Austria

ORDERING REQUIREMENTS:

- Model number
- Top surface
- Top finish, as applicable
- Column/base finish
- Options, as applicable

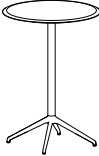
| MODEL | veneER TOP (-V) | LAMINATE TOP (-L) | FENIX TOP (-FE) | SOLID SURFACE TOP (-SF) | BACK-PAINTED GLASS TOP (-GL) | WEIGHT |
|--|-----------------|-------------------|-----------------|-------------------------|------------------------------|---------|
|  <p>☼ Round Top, 29" Height</p> | 5220-3029-() | 2,204 | 2,492 | 2,898 | 2,582 | 38 lbs. |
| | 5220-3629-() | 2,637 | 3,052 | 3,636 | 3,154 | 48 lbs. |
| | 5220-4229-() | 2,751 | 3,315 | 4,111 | 3,283 | 59 lbs. |
|  <p>☼ Round Top, 42" Height</p> | 5220-3042-() | 2,363 | 2,651 | 3,057 | 2,743 | 38 lbs. |
| | 5220-3642-() | 2,796 | 3,211 | 3,795 | 3,323 | 48 lbs. |
| | 5220-4242-() | 2,911 | 3,475 | 4,271 | 3,448 | 59 lbs. |

OPTIONS

- PFM02 Premium Metal Base Finish \$101
- PFW04 Premium Wood Top Finish \$46
- PNI-() **☼** Power Node \$724
(Not available on models with glass tops)

Note: please specify (-C) for chrome and (-W) for white on Power Node Units.



☼ = Available on quick-ship program (veneER, laminate, Fenix and solid surface tops with 0535 Metallic Silver or 0299 Polished Aluminum base finishes only).

All shipments for this series will be blanket-wrapped as standard. For customers located in Territory 1 who require cartoning, a 5% upcharge will be added to each product. Please contact client services for additional information.

MELINA MEETING TABLES | Licensed from Wiesner Hager - Austria

ORDERING REQUIREMENTS:

- Model number
- Top surface
- Top finish, as applicable
- Column/base finish
- Options, as applicable

| MODEL | veneER TOP (-V) | LAMINATE TOP (-L) | FENIX TOP (-FE) | SOLID SURFACE TOP (-SF) | BACK-PAINTED GLASS TOP (-GL) | WEIGHT |
|---|-----------------|-------------------|-----------------|-------------------------|------------------------------|---------|
|  <p>☼ Square Top, 29" Height</p> | 5225-303029-() | 2,205 | 2,493 | 2,899 | 2,619 | 38 lbs. |
| | 5225-363629-() | 2,639 | 3,054 | 3,638 | 3,203 | 48 lbs. |
| | 5225-424229-() | 2,757 | 3,321 | 4,117 | 3,328 | 59 lbs. |
|  <p>☼ Square Top, 42" Height</p> | 5225-303042-() | 2,366 | 2,654 | 3,060 | 2,785 | 42 lbs. |
| | 5225-363642-() | 2,798 | 3,213 | 3,797 | 3,366 | 52 lbs. |
| | 5225-424242-() | 2,831 | 3,395 | 4,191 | 3,494 | 63 lbs. |

OPTIONS

- PFM02 Premium Metal Base Finish \$101
- PFW04 Premium Wood Top Finish \$46
- PNI-() **☼** Power Node \$724
(Not available on models with glass tops)

Note: please specify (-C) for chrome and (-W) for white on Power Node Units.

☼ = Available on quick-ship program (veneER, laminate, Fenix and solid surface tops with 0535 Metallic Silver or 0299 Polished Aluminum base finishes only).

MELINA OCCASIONAL TABLES | Licensed from Wiesner Hager - Austria

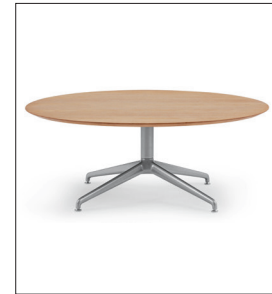

SPECIFICATIONS:

- Round and square top shapes offered in 16" height.
- Four table surface options: wood veneer, laminate, Fenix solid surface or Starphire® glass.
- Wood veneer available in all standard and custom finishes on Ash.
- For custom wood finishes, please contact client services and add one-time upcharge of \$531 List per color per order.
- For Alabaster and Super Matte Sable Ash, premium wood finish upcharge applies. Refer to options section for pricing.
- For custom laminate options, add \$649 List per color per order. Pre-approval required, please contact client services.
- Fenix offered in five standard colorways.
- For non-standard Fenix colors, please contact client services for pricing.
- For veneer, standard wood grain and solid black laminate, as well as Fenix Nero Ingo (black), edge will match top finish color, unless specified otherwise.
- For all other finishes, edge will be exposed plywood with a clear coat finish as standard.
- Solid surface available in white only.
- Glass tops are back-painted white as standard.
- Back-painted glass and solid surface tops feature exposed plywood substrate edge with clear coat finish.
- Column and base offered in standard and premium metal finishes. Please refer to listing below.
- All dimensions are nominal.
- Refer to terms and conditions for general information regarding finishes, warranty, freight, complete condition of sales and more.

STANDARD METAL COLUMN/BASE FINISH COLORS:

- 0405 Charcoal Grey
- 0535 Metallic Silver
- 0299 Polished Aluminum
- 0630 Satin Black

PREMIUM METAL COLUMN/BASE FINISH COLORS:

- 0605 Matte Black
- 0705 Matte Cotton
- 0788 Glossy Cotton
- 0805 Oasis
- 0905 Mint
- 1005 Mercury
- 1105 Canary
- 1205 Stone
- 1305 Sage
- 1405 Ice Blue
- 1505 Clay

All shipments for this series will be blanket-wrapped as standard. For customers located in Territory 1 who require cartoning, a 5% upcharge will be added to each product. Please contact client services for additional information.

POWER NODE UNIT:

- Available on all top surfaces excluding glass.
- Power Node is 3-3/8" in diameter and 72" electrical cord.
- Chrome and white color options.
- Unless specified otherwise, unit will be positioned in center of table-top.



Power Node (PNI):

- One outlet, one USB-A and one USB-C charging port.

EDGE DETAIL:

Laminate*/Veneer/Fenix Top



Exposed Plywood Edge

Glass Top



1/4" Exposed Plywood Substrate

Solid Surface Top



1/4" Plywood Substrate



*Please note that laminate thickness is nominal and may vary.

All shipments for this series will be blanket-wrapped as standard. For customers located in Territory 1 who require cartoning, a 5% upcharge will be added to each product. Please contact client services for additional information.

MELINA OCCASIONAL TABLES | Licensed from Wiesner Hager - Austria

ORDERING REQUIREMENTS:

- Model number
- Top surface
- Top finish, as applicable
- Column/base finish
- Options, as applicable

| MODEL | veneER TOP (-V) | LAMINATE TOP (-L) | FENIX TOP (-FE) | SOLID SURFACE TOP (-SF) | BACK-PAINTED GLASS TOP (-GL) | WEIGHT |
|--|-----------------|-------------------|-----------------|-------------------------|------------------------------|---------|
|  Round Top, 16" Height 5220-3016-() 5220-3616-() 5220-4216-() | 2,065 | 1,971 | 2,259 | 2,665 | 2,351 | 34 lbs. |
| | 2,581 | 2,404 | 2,819 | 3,403 | 2,915 | 44 lbs. |
| | 2,693 | 2,520 | 3,084 | 3,880 | 3,052 | 55 lbs. |
|  Square Top, 16" Height 5225-303016-() 5225-363616-() 5225-424216-() | 2,108 | 1,972 | 2,260 | 2,666 | 2,382 | 34 lbs. |
| | 2,627 | 2,406 | 2,821 | 3,405 | 2,966 | 44 lbs. |
| | 2,735 | 2,526 | 3,090 | 3,886 | 3,091 | 55 lbs. |

OPTIONS

- PFM02 Premium Metal Base Finish \$101
- PFW04 Premium Wood Top Finish \$46
- PNI-()  Power Node \$724
(Not available on models with glass tops)

Note: please specify (-C) for chrome and (-W) for white on Power Node Units.

 = Available on quick-ship program (veneER, laminate, Fenix and solid surface tops with 0535 Metallic Silver or 0299 Polished Aluminum base finishes only).

All shipments for this series will be cartoned as standard. If blanket-wrapped shipping is required, please contact client services for additional information.

MEMENTO EXECUTIVE



SPECIFICATIONS:

- Fully upholstered seat and back.
- Channel back stitching also offered.
- Armless, adjustable t-arm and polished aluminum cantilever arm models.
- Polished aluminum cantilever arm features black soft-touch arm cap.
- Optional fully polished aluminum cantilever arm without arm cap also available.
- Adjustable t-arms available with chrome trim detail.
- Adjustable t-arm features 4" arm height adjustment as standard.
- Fixed back height.
- Memory foam standard on seat.
- Swivel-tilt with tilt lock, synchro-tilt and synchro knee-tilt mechanisms available.
- Two base options: black nylon and polished aluminum.
- 300 lb. weight capacity.
- Ships KD (knocked down).
- All dimensions are nominal.
- Refer to terms and conditions for general information regarding fabrics, finishes, warranty, freight, complete condition of sales and more.



All shipments for this series will be cartoned as standard. If blanket-wrapped shipping is required, please contact client services for additional information.

MEMENTO EXECUTIVE

Swivel-Tilt with Tilt Lock Mechanism

ORDERING REQUIREMENTS:

- Model number
- Base finish
- Upholstery selection
- Options, as applicable

| MODEL | PRODUCT SPECIFICATIONS | BASE FINISH | FABRIC GRADES | | | | | | | | LEATHER | | | |
|--|--|---------------------------|---------------|-------|-------|-------|-------|-------|----------|-------|---------|-------|-------|-------|
| | | | COM | A | 1 | 2 | 3 | 4 | COL 5 | 6 | 7 | 8 | L1 | L2 |
| 5551-U  | Ⓞ Upholstered Back, Armless 20" W x 22" D x 39"- 44" H Seat: 20.5" W x 18.5" D Seat Ht: 17" - 22" Back: 19" W x 24" H COM: 1.5 yds. COL: 30 sq. ft. 32 lbs. | Black Nylon | 1,340 | 1,442 | 1,496 | 1,529 | 1,582 | 1,639 | 1,690 | 1,742 | 1,795 | 1,849 | 2,096 | 2,276 |
| | | Polished Aluminum (-AB01) | 1,455 | 1,557 | 1,611 | 1,644 | 1,697 | 1,754 | 1,805 | 1,857 | 1,910 | 1,964 | 2,211 | 2,391 |
| 5553-U  | Ⓞ Upholstered Back, Adjustable T-Arms 27" W x 22" D x 39"- 44" H Seat: 20.5" W x 18.5" D Seat Ht: 17" - 22" Back: 19" W x 24" H COM: 1.5 yds. COL: 30 sq. ft. 38 lbs. | Black Nylon | 1,558 | 1,660 | 1,714 | 1,747 | 1,800 | 1,857 | 1,908 | 1,960 | 2,013 | 2,067 | 2,314 | 2,494 |
| | | Polished Aluminum (-AB01) | 1,673 | 1,775 | 1,829 | 1,862 | 1,915 | 1,972 | 2,023 | 2,075 | 2,128 | 2,182 | 2,429 | 2,609 |
| 5554-U  | Ⓞ Upholstered Back, Polished Aluminum Cantilever Arms 24.5" W x 22" D x 39"- 44" H Seat: 20.5" W x 18.5" D Seat Ht: 17" - 22" Back: 19" W x 24" H COM: 1.5 yds. COL: 30 sq. ft. 38 lbs. | Black Nylon | 1,592 | 1,694 | 1,748 | 1,781 | 1,834 | 1,891 | 1,942 | 1,994 | 2,047 | 2,101 | 2,348 | 2,528 |
| | | Polished Aluminum (-AB01) | 1,707 | 1,809 | 1,863 | 1,896 | 1,949 | 2,006 | 2,057 | 2,109 | 2,162 | 2,216 | 2,463 | 2,643 |

Note:
For two-tone upholstery, COM requirements are .75 yd. for seat and 1 yd. for back.

OPTIONS

| | | | | | |
|--------|---|------|---------|---------------------------------|-------|
| -FP01 | Fully Polished Arms (no arm cap) (5554-U model only) | \$80 | -STLC02 | Soft Tread Self-Locking Casters | \$63 |
| -WA01 | Width Adjustable Arms | \$38 | -GD04 | Glides | \$30 |
| -PV01 | Pivot Arms | \$71 | -SK01 | Stool Kit* | \$120 |
| -STC02 | Soft Tread Casters | \$33 | -J01 | Jury Base (black only) | \$199 |

* Stool models feature non-tilting mechanism.

Ⓞ = Available on quick-ship program.







All shipments for this series will be cartoned as standard. If blanket-wrapped shipping is required, please contact client services for additional information.

MEMENTO EXECUTIVE

Synchro Knee-Tilt Mechanism

ORDERING REQUIREMENTS:

- Model number
- Base finish
- Upholstery selection
- Options, as applicable

| MODEL | PRODUCT SPECIFICATIONS | BASE FINISH | FABRIC GRADES | | | | | | | | LEATHER | | | |
|--|--|----------------------------------|---------------|-------|-------|-------|-------|-------|----------|-------|---------|-------|-------|-------|
| | | | COM | A | 1 | 2 | 3 | 4 | COL 5 | 6 | 7 | 8 | L1 | L2 |
| 5581-U  |  Upholstered Back, Armless 20" W x 22" D x 39"- 44" H Seat: 20.5" W x 18.5" D Seat Ht: 17" - 22" Back: 19" W x 24" H COM: 1.5 yds. COL: 30 sq. ft. 34 lbs. | Black Nylon | 1,585 | 1,687 | 1,741 | 1,774 | 1,827 | 1,884 | 1,935 | 1,987 | 2,040 | 2,094 | 2,341 | 2,521 |
| | | Polished Aluminum (-AB01) | 1,700 | 1,802 | 1,856 | 1,889 | 1,942 | 1,999 | 2,050 | 2,102 | 2,155 | 2,209 | 2,456 | 2,636 |
| 5583-U  |  Upholstered Back, Adjustable T-Arms 27" W x 22" D x 39"- 44" H Seat: 20.5" W x 18.5" D Seat Ht: 17" - 22" Back: 19" W x 24" H COM: 1.5 yds. COL: 30 sq. ft. 40 lbs. | Black Nylon | 1,803 | 1,905 | 1,959 | 1,992 | 2,045 | 2,102 | 2,153 | 2,205 | 2,258 | 2,312 | 2,559 | 2,739 |
| | | Polished Aluminum (-AB01) | 1,918 | 2,020 | 2,074 | 2,107 | 2,160 | 2,217 | 2,268 | 2,320 | 2,373 | 2,427 | 2,674 | 2,854 |
| 5584-U  |  Upholstered Back, Polished Aluminum Cantilever Arms 24.5" W x 22" D x 39"- 44" H Seat: 20.5" W x 18.5" D Seat Ht: 17" - 22" Back: 19" W x 24" H COM: 1.5 yds. COL: 30 sq. ft. 40 lbs. | Black Nylon | 1,837 | 1,939 | 1,993 | 2,026 | 2,079 | 2,136 | 2,187 | 2,239 | 2,292 | 2,346 | 2,593 | 2,773 |
| | | Polished Aluminum (-AB01) | 1,952 | 2,054 | 2,108 | 2,141 | 2,194 | 2,251 | 2,302 | 2,354 | 2,407 | 2,461 | 2,708 | 2,888 |

Note:
For two-tone upholstery, COM requirements are .75 yd. for seat and 1 yd. for back.

OPTIONS

| | | | | | |
|--------|---|------|---------|---------------------------------|-------|
| -FP01 | Fully Polished Arms (no arm cap) (5584-U model only) | \$80 | -STLC02 | Soft Tread Self-Locking Casters | \$63 |
| -WA01 | Width Adjustable Arms | \$38 | -GD04 | Glides | \$30 |
| -PV01 | Pivot Arms | \$71 | -J01 | Jury Base (black only) | \$199 |
| -STC02 | Soft Tread Casters | \$33 | | | |

 = Available on quick-ship program.



All shipments for this series will be cartoned as standard. If blanket-wrapped shipping is required, please contact client services for additional information.

MEMENTO EXECUTIVE

Synchro-Tilt Mechanism

ORDERING REQUIREMENTS:

- Model number
- Base finish
- Upholstery selection
- Options, as applicable

| MODEL | PRODUCT SPECIFICATIONS | BASE FINISH | FABRIC GRADES | | | | | | | | | | LEATHER | |
|--|--|----------------------------------|---------------|-------|-------|-------|-------|-------|-------|-------|-------|-------|---------|-------|
| | | | COM | A | 1 | 2 | 3 | 4 | COL 5 | 6 | 7 | 8 | L1 | L2 |
| 5591-U  | Ⓢ Upholstered Back, Armless 20" W x 22" D x 39"- 44" H Seat: 20.5" W x 18.5" D Seat Ht: 17" - 22" Back: 19" W x 24" H COM: 1.5 yds. COL: 30 sq. ft. 32 lbs. | Black Nylon | 1,417 | 1,519 | 1,573 | 1,606 | 1,659 | 1,716 | 1,767 | 1,819 | 1,872 | 1,926 | 2,173 | 2,353 |
| | | Polished Aluminum (-AB01) | 1,532 | 1,634 | 1,688 | 1,721 | 1,774 | 1,831 | 1,882 | 1,934 | 1,987 | 2,041 | 2,288 | 2,468 |
| 5593-U  | Ⓢ Upholstered Back, Adjustable T-Arms 27" W x 22" D x 39"- 44" H Seat: 20.5" W x 18.5" D Seat Ht: 17" - 22" Back: 19" W x 24" H COM: 1.5 yds. COL: 30 sq. ft. 38 lbs. | Black Nylon | 1,635 | 1,737 | 1,791 | 1,824 | 1,877 | 1,934 | 1,985 | 2,037 | 2,090 | 2,144 | 2,391 | 2,571 |
| | | Polished Aluminum (-AB01) | 1,750 | 1,852 | 1,906 | 1,939 | 1,992 | 2,049 | 2,100 | 2,152 | 2,205 | 2,259 | 2,506 | 2,686 |
| 5594-U  | Ⓢ Upholstered Back, Polished Aluminum Cantilever Arms 24.5" W x 22" D x 39"- 44" H Seat: 20.5" W x 18.5" D Seat Ht: 17" - 22" Back: 19" W x 24" H COM: 1.5 yds. COL: 30 sq. ft. 38 lbs. | Black Nylon | 1,669 | 1,771 | 1,825 | 1,858 | 1,911 | 1,968 | 2,019 | 2,071 | 2,124 | 2,178 | 2,425 | 2,605 |
| | | Polished Aluminum (-AB01) | 1,784 | 1,886 | 1,940 | 1,973 | 2,026 | 2,083 | 2,134 | 2,186 | 2,239 | 2,293 | 2,540 | 2,720 |

Note:
For two-tone upholstery, COM requirements are .75 yd. for seat and 1 yd. for back.

OPTIONS

| | | | | | |
|-------|--|-------|---------|---------------------------------|-------|
| -FP01 | Fully Polished Arms (no arm cap) (5594-U model only) | \$80 | -STC02 | Soft Tread Casters | \$33 |
| -WA01 | Width Adjustable Arms | \$38 | -STLC02 | Soft Tread Self-Locking Casters | \$63 |
| -PV01 | Pivot Arms | \$71 | -GD04 | Glides | \$30 |
| -SS01 | Seat Slider | \$102 | -J01 | Jury Base (black only) | \$199 |

Ⓢ = Available on quick-ship program.



All shipments for this series will be cartoned as standard. If blanket-wrapped shipping is required, please contact client services for additional information.

MEMENTO EXECUTIVE

Swivel-Tilt with Tilt Lock Mechanism

ORDERING REQUIREMENTS:

- Model number
- Base finish
- Upholstery selection
- Options, as applicable

| MODEL | PRODUCT SPECIFICATIONS | BASE FINISH | FABRIC GRADES | | | | | | | | LEATHER | | | |
|--|--|----------------------------------|---------------|-------|-------|-------|-------|-------|----------|-------|---------|-------|-------|-------|
| | | | COM | A | 1 | 2 | 3 | 4 | COL 5 | 6 | 7 | 8 | L1 | L2 |
| 5551-C  | Upholstered Channel Back, Armless 20" W x 22" D x 39"- 44" H Seat: 20.5" W x 18.5" D Seat Ht: 17" - 22" Back: 19" W x 24" H COM: 1.5 yds. COL: 30 sq. ft. 32 lbs. | Black Nylon | 1,420 | 1,522 | 1,576 | 1,609 | 1,662 | 1,719 | 1,770 | 1,822 | 1,875 | 1,929 | 2,176 | 2,356 |
| | | Polished Aluminum (-AB01) | 1,535 | 1,637 | 1,691 | 1,724 | 1,777 | 1,834 | 1,885 | 1,937 | 1,990 | 2,044 | 2,291 | 2,471 |
| 5553-C  | Upholstered Channel Back, Adjustable T-Arms 27" W x 22" D x 39"- 44" H Seat: 20.5" W x 18.5" D Seat Ht: 17" - 22" Back: 19" W x 24" H COM: 1.5 yds. COL: 30 sq. ft. 38 lbs. | Black Nylon | 1,638 | 1,740 | 1,794 | 1,827 | 1,880 | 1,937 | 1,988 | 2,040 | 2,093 | 2,147 | 2,394 | 2,574 |
| | | Polished Aluminum (-AB01) | 1,753 | 1,855 | 1,909 | 1,942 | 1,995 | 2,052 | 2,103 | 2,155 | 2,208 | 2,262 | 2,509 | 2,689 |
| 5554-C  | Upholstered Channel Back, Polished Aluminum Cantilever Arms 24.5" W x 22" D x 39"- 44" H Seat: 20.5" W x 18.5" D Seat Ht: 17" - 22" Back: 19" W x 24" H COM: 1.5 yds. COL: 30 sq. ft. 38 lbs. | Black Nylon | 1,672 | 1,774 | 1,828 | 1,861 | 1,914 | 1,971 | 2,022 | 2,074 | 2,127 | 2,181 | 2,428 | 2,608 |
| | | Polished Aluminum (-AB01) | 1,787 | 1,889 | 1,943 | 1,976 | 2,029 | 2,086 | 2,137 | 2,189 | 2,242 | 2,296 | 2,543 | 2,723 |

Note:
For two-tone upholstery, COM requirements are .75 yd. for seat and 1 yd. for back.

OPTIONS

| | | | | | |
|---------|--|------|-------|------------------------|-------|
| -FP01 | Fully Polished Arms (no arm cap) (5554-C model only) | \$80 | -GD04 | Glides | \$30 |
| -WA01 | Width Adjustable Arms | \$38 | -SK01 | Stool Kit* | \$120 |
| -PV01 | Pivot Arms | \$71 | -J01 | Jury Base (black only) | \$199 |
| -STC02 | Soft Tread Casters | \$33 | | | |
| -STLC02 | Soft Tread Self-Locking Casters | \$63 | | | |

* Stool models feature non-tilting mechanism.



All shipments for this series will be cartoned as standard. If blanket-wrapped shipping is required, please contact client services for additional information.

MEMENTO EXECUTIVE

Synchro Knee-Tilt Mechanism

ORDERING REQUIREMENTS:

- Model number
- Base finish
- Upholstery selection
- Options, as applicable

| MODEL | PRODUCT SPECIFICATIONS | BASE FINISH | FABRIC GRADES | | | | | | | | LEATHER | | | |
|--|--|----------------------------------|---------------|-------|-------|-------|-------|-------|----------|-------|---------|-------|-------|-------|
| | | | COM | A | 1 | 2 | 3 | 4 | COL 5 | 6 | 7 | 8 | L1 | L2 |
| 5581-C  | Upholstered Channel Back, Armless 20" W x 22" D x 39"- 44" H Seat: 20.5" W x 18.5" D Seat Ht: 17" - 22" Back: 19" W x 24" H COM: 1.5 yds. COL: 30 sq. ft. 34 lbs. | Black Nylon | 1,663 | 1,765 | 1,819 | 1,852 | 1,905 | 1,962 | 2,013 | 2,065 | 2,118 | 2,172 | 2,419 | 2,599 |
| | | Polished Aluminum (-AB01) | 1,778 | 1,880 | 1,934 | 1,967 | 2,020 | 2,077 | 2,128 | 2,180 | 2,233 | 2,287 | 2,534 | 2,714 |
| 5583-C  | Upholstered Channel Back, Adjustable T-Arms 27" W x 22" D x 39"- 44" H Seat: 20.5" W x 18.5" D Seat Ht: 17" - 22" Back: 19" W x 24" H COM: 1.5 yds. COL: 30 sq. ft. 40 lbs. | Black Nylon | 1,881 | 1,983 | 2,037 | 2,070 | 2,123 | 2,180 | 2,231 | 2,283 | 2,336 | 2,390 | 2,637 | 2,817 |
| | | Polished Aluminum (-AB01) | 1,996 | 2,098 | 2,152 | 2,185 | 2,238 | 2,295 | 2,346 | 2,398 | 2,451 | 2,505 | 2,752 | 2,932 |
| 5584-C  | Upholstered Channel Back, Polished Aluminum Cantilever Arms 24.5" W x 22" D x 39"- 44" H Seat: 20.5" W x 18.5" D Seat Ht: 17" - 22" Back: 19" W x 24" H COM: 1.5 yds. COL: 30 sq. ft. 40 lbs. | Black Nylon | 1,915 | 2,017 | 2,071 | 2,104 | 2,157 | 2,214 | 2,265 | 2,317 | 2,370 | 2,424 | 2,671 | 2,851 |
| | | Polished Aluminum (-AB01) | 2,030 | 2,132 | 2,186 | 2,219 | 2,272 | 2,329 | 2,380 | 2,432 | 2,485 | 2,539 | 2,786 | 2,966 |

Note:
For two-tone upholstery, COM requirements are .75 yd. for seat and 1 yd. for back.

OPTIONS

| | | | | | |
|-------|--|------|---------|---------------------------------|-------|
| -FP01 | Fully Polished Arms (no arm cap) (5584-C model only) | \$80 | -STC02 | Soft Tread Casters | \$33 |
| -WA01 | Width Adjustable Arms | \$38 | -STLC02 | Soft Tread Self-Locking Casters | \$63 |
| -PV01 | Pivot Arms | \$71 | -GD04 | Glides | \$30 |
| | | | -J01 | Jury Base (black only) | \$199 |



All shipments for this series will be cartoned as standard. If blanket-wrapped shipping is required, please contact client services for additional information.

MEMENTO EXECUTIVE

Synchro-Tilt Mechanism

ORDERING REQUIREMENTS:

- Model number
- Base finish
- Upholstery selection
- Options, as applicable

| MODEL | PRODUCT SPECIFICATIONS | BASE FINISH | FABRIC GRADES | | | | | | | | LEATHER | | | |
|--|--|----------------------------------|---------------|-------|-------|-------|-------|-------|----------|-------|---------|-------|-------|-------|
| | | | COM | A | 1 | 2 | 3 | 4 | COL 5 | 6 | 7 | 8 | L1 | L2 |
| 5591-C  | Upholstered Channel Back, Armless 20" W x 22" D x 39"- 44" H Seat: 20.5" W x 18.5" D Seat Ht: 17" - 22" Back: 19" W x 24" H COM: 1.5 yds. COL: 30 sq. ft. 32 lbs. | Black Nylon | 1,478 | 1,580 | 1,634 | 1,667 | 1,720 | 1,777 | 1,828 | 1,880 | 1,933 | 1,987 | 2,234 | 2,414 |
| | | Polished Aluminum (-AB01) | 1,593 | 1,695 | 1,749 | 1,782 | 1,835 | 1,892 | 1,943 | 1,995 | 2,048 | 2,102 | 2,349 | 2,529 |
| 5593-C  | Upholstered Channel Back, Adjustable T-Arms 27" W x 22" D x 39"- 44" H Seat: 20.5" W x 18.5" D Seat Ht: 17" - 22" Back: 19" W x 24" H COM: 1.5 yds. COL: 30 sq. ft. 38 lbs. | Black Nylon | 1,696 | 1,798 | 1,852 | 1,885 | 1,938 | 1,995 | 2,046 | 2,098 | 2,151 | 2,205 | 2,452 | 2,632 |
| | | Polished Aluminum (-AB01) | 1,811 | 1,913 | 1,967 | 2,000 | 2,053 | 2,110 | 2,161 | 2,213 | 2,266 | 2,320 | 2,567 | 2,747 |
| 5594-C  | Upholstered Channel Back, Polished Aluminum Cantilever Arms 24.5" W x 22" D x 39"- 44" H Seat: 20.5" W x 18.5" D Seat Ht: 17" - 22" Back: 19" W x 24" H COM: 1.5 yds. COL: 30 sq. ft. 38 lbs. | Black Nylon | 1,730 | 1,832 | 1,886 | 1,919 | 1,972 | 2,029 | 2,080 | 2,132 | 2,185 | 2,239 | 2,486 | 2,666 |
| | | Polished Aluminum (-AB01) | 1,845 | 1,947 | 2,001 | 2,034 | 2,087 | 2,144 | 2,195 | 2,247 | 2,300 | 2,354 | 2,601 | 2,781 |

Note:
For two-tone upholstery, COM requirements are .75 yd. for seat and 1 yd. for back.

OPTIONS

| | | | | | |
|-------|--|-------|---------|---------------------------------|-------|
| -FP01 | Fully Polished Arms (no arm cap) (5594-C model only) | \$80 | -STC02 | Soft Tread Casters | \$33 |
| -SS01 | Seat Slider | \$102 | -STLC02 | Soft Tread Self-Locking Casters | \$63 |
| -WA01 | Width Adjustable Arms | \$38 | -GD04 | Glides | \$30 |
| -PV01 | Pivot Arms | \$71 | -J01 | Jury Base (black only) | \$199 |

All shipments for this series will be cartoned as standard. If blanket-wrapped shipping is required, please contact client services for additional information.

MEMENTO TASK

Please note that effective April 1st, 2025, a 4.5% tariff surcharge will be applied to the net subtotal on all orders.



SPECIFICATIONS:

- Fully upholstered back and seat.
- Channel back stitching also offered.
- Armless, adjustable t-arm and polished aluminum cantilever arm models.
- Polished aluminum cantilever arm features black soft-touch arm cap.
- Adjustable t-arms available with chrome trim detail.
- Adjustable t-arm features 4" arm height adjustment as standard.
- 2½" back height adjustment.
- Memory foam standard on seat.
- Swivel-tilt with tilt lock, task intensive and synchro-tilt mechanism.
- Stool models feature non-tilting mechanism.
- Two base options: black nylon and polished aluminum.
- 300 lb. weight capacity.
- Ships KD (knocked down).
- All dimensions are nominal.
- Refer to terms and conditions for general information regarding fabrics, finishes, warranty, freight, complete condition of sales and more.



All shipments for this series will be cartoned as standard. If blanket-wrapped shipping is required, please contact client services for additional information.

MEMENTO TASK

Task Intensive Mechanism

ORDERING REQUIREMENTS:

- Model number
- Base finish
- Upholstery selection
- Options, as applicable

| MODEL | PRODUCT SPECIFICATIONS | BASE FINISH | FABRIC GRADES | | | | | | | | | | LEATHER | |
|--|--|---------------------------|---------------|-------|-------|-------|-------|-------|----------|-------|-------|-------|---------|-------|
| | | | COM | A | 1 | 2 | 3 | 4 | COL 5 | 6 | 7 | 8 | L1 | L2 |
| 5641-U  | Ⓢ Upholstered Back, Armless 20" W x 22" D x 34.5"- 39.5" H Seat: 20.5" W x 18" D Seat Ht: 17" - 22" Back: 18.5" W x 20" H COM: 1.5 yds. COL: 30 sq. ft. 44 lbs. | Black Nylon | 1,356 | 1,458 | 1,512 | 1,545 | 1,598 | 1,655 | 1,706 | 1,758 | 1,811 | 1,865 | 2,112 | 2,292 |
| | | Polished Aluminum (-AB01) | 1,471 | 1,573 | 1,627 | 1,660 | 1,713 | 1,770 | 1,821 | 1,873 | 1,926 | 1,980 | 2,227 | 2,407 |
| 5643-U  | Ⓢ Upholstered Back, Adjustable T-Arms 27" W x 22" D x 34.5"- 39.5" H Seat: 20.5" W x 18" D Seat Ht: 17" - 22" Back: 18.5" W x 20" H COM: 1.5 yds. COL: 30 sq. ft. 50 lbs. | Black Nylon | 1,574 | 1,676 | 1,730 | 1,763 | 1,816 | 1,873 | 1,924 | 1,976 | 2,029 | 2,083 | 2,330 | 2,510 |
| | | Polished Aluminum (-AB01) | 1,689 | 1,791 | 1,845 | 1,878 | 1,931 | 1,988 | 2,039 | 2,091 | 2,144 | 2,198 | 2,445 | 2,625 |
| 5644-U  | Ⓢ Upholstered Back, Polished Aluminum Cantilever Arms 24.5" W x 22" D x 34.5"- 39.5" H Seat: 20.5" W x 18" D Seat Ht: 17" - 22" Back: 18.5" W x 20" H COM: 1.5 yds. COL: 30 sq. ft. 50 lbs. | Black Nylon | 1,608 | 1,710 | 1,764 | 1,797 | 1,850 | 1,907 | 1,958 | 2,010 | 2,063 | 2,117 | 2,364 | 2,544 |
| | | Polished Aluminum (-AB01) | 1,723 | 1,825 | 1,879 | 1,912 | 1,965 | 2,022 | 2,073 | 2,125 | 2,178 | 2,232 | 2,479 | 2,659 |

Note:
For two-tone upholstery, COM requirements are .75 yd. for seat and 1 yd. for back.

OPTIONS

| | | | | | |
|-------|--|-------|---------|---------------------------------|-------|
| -FP01 | Fully Polished Arms (no arm cap) (5644-U model only) | \$80 | -STC02 | Soft Tread Casters | \$33 |
| -SS01 | Seat Slider | \$102 | -STLC02 | Soft Tread Self-Locking Casters | \$63 |
| -WA01 | Width Adjustable Arms | \$38 | -GD04 | Glides | \$30 |
| -PV01 | Pivot Arms | \$71 | -J01 | Jury Base (black only) | \$199 |

Ⓢ = Available on quick-ship program.



All shipments for this series will be cartoned as standard. If blanket-wrapped shipping is required, please contact client services for additional information.

MEMENTO TASK

Swivel-Tilt with Tilt Lock Mechanism

ORDERING REQUIREMENTS:

- Model number
- Base finish
- Upholstery selection
- Options, as applicable

| MODEL | PRODUCT SPECIFICATIONS | BASE FINISH | FABRIC GRADES | | | | | | | | LEATHER | | | |
|--|--|----------------------------------|---------------|-------|-------|-------|-------|-------|-------|-------|---------|-------|-------|-------|
| | | | COM | A | 1 | 2 | 3 | 4 | COL 5 | 6 | 7 | 8 | L1 | L2 |
| 5651-U  | Q/S Upholstered Back, Armless 20" W x 22" D x 34.5"- 39.5" H Seat: 20.5" W x 18" D Seat Ht: 17" - 22" Back: 18.5" W x 20" H COM: 1.5 yds. COL: 30 sq. ft. 36 lbs. | Black Nylon | 1,268 | 1,370 | 1,424 | 1,457 | 1,510 | 1,567 | 1,618 | 1,670 | 1,723 | 1,777 | 2,024 | 2,204 |
| | | Polished Aluminum (-AB01) | 1,383 | 1,485 | 1,539 | 1,572 | 1,625 | 1,682 | 1,733 | 1,785 | 1,838 | 1,892 | 2,139 | 2,319 |
| 5653-U  | Q/S Upholstered Back, Adjustable T-Arms 27" W x 22" D x 34.5"- 39.5" H Seat: 20.5" W x 18" D Seat Ht: 17" - 22" Back: 18.5" W x 20" H COM: 1.5 yds. COL: 30 sq. ft. 42 lbs. | Black Nylon | 1,486 | 1,588 | 1,642 | 1,675 | 1,728 | 1,785 | 1,836 | 1,888 | 1,941 | 1,995 | 2,242 | 2,422 |
| | | Polished Aluminum (-AB01) | 1,601 | 1,703 | 1,757 | 1,790 | 1,843 | 1,900 | 1,951 | 2,003 | 2,056 | 2,110 | 2,357 | 2,537 |
| 5654-U  | Q/S Upholstered Back, Polished Aluminum Cantilever Arms 24.5" W x 22" D x 34.5"- 39.5" H Seat: 20.5" W x 18" D Seat Ht: 17" - 22" Back: 18.5" W x 20" H COM: 1.5 yds. COL: 30 sq. ft. 42 lbs. | Black Nylon | 1,520 | 1,622 | 1,676 | 1,709 | 1,762 | 1,819 | 1,870 | 1,922 | 1,975 | 2,029 | 2,276 | 2,456 |
| | | Polished Aluminum (-AB01) | 1,635 | 1,737 | 1,791 | 1,824 | 1,877 | 1,934 | 1,985 | 2,037 | 2,090 | 2,144 | 2,391 | 2,571 |

Note:
For two-tone upholstery, COM requirements are .75 yd. for seat and 1 yd. for back.

OPTIONS

| | | | | | |
|--------|--|-------|---------|---------------------------------|-------|
| -FP01 | Fully Polished Arms (no arm cap) (5654-U model only) | \$80 | -STLC02 | Soft Tread Self-Locking Casters | \$63 |
| -SS01 | Seat Slider | \$102 | -GD04 | Glides | \$30 |
| -WA01 | Width Adjustable Arms | \$38 | -SK01 | Stool Kit ¹ | \$120 |
| -PV01 | Pivot Arms | \$71 | -J01 | Jury Base (black only) | \$199 |
| -STC02 | Soft Tread Casters | \$33 | | | |

¹ Stool models feature non-tilting mechanism.

 = Available on quick-ship program.







All shipments for this series will be cartoned as standard. If blanket-wrapped shipping is required, please contact client services for additional information.

MEMENTO TASK

Synchro-Tilt Mechanism

ORDERING REQUIREMENTS:

- Model number
- Base finish
- Upholstery selection
- Options, as applicable

| MODEL | PRODUCT SPECIFICATIONS | BASE FINISH | FABRIC GRADES | | | | | | | | | | LEATHER | |
|--|--|----------------------------------|---------------|-------|-------|-------|-------|-------|----------|-------|-------|-------|---------|-------|
| | | | COM | A | 1 | 2 | 3 | 4 | COL 5 | 6 | 7 | 8 | L1 | L2 |
| 5691-U  |  Upholstered Back, Armless 20" W x 22" D x 34.5"- 39.5" H Seat: 20.5" W x 18" D Seat Ht: 17" - 22" Back: 18.5" W x 20" H COM: 1.5 yds. COL: 30 sq. ft. 37 lbs. | Black Nylon | 1,330 | 1,432 | 1,486 | 1,519 | 1,572 | 1,629 | 1,680 | 1,732 | 1,785 | 1,839 | 2,086 | 2,266 |
| | | Polished Aluminum (-AB01) | 1,445 | 1,547 | 1,601 | 1,634 | 1,687 | 1,744 | 1,795 | 1,847 | 1,900 | 1,954 | 2,201 | 2,381 |
| 5693-U  |  Upholstered Back, Adjustable T-Arms 27" W x 22" D x 34.5"- 39.5" H Seat: 20.5" W x 18" D Seat Ht: 17" - 22" Back: 18.5" W x 20" H COM: 1.5 yds. COL: 30 sq. ft. 43 lbs. | Black Nylon | 1,548 | 1,650 | 1,704 | 1,737 | 1,790 | 1,847 | 1,898 | 1,950 | 2,003 | 2,057 | 2,304 | 2,484 |
| | | Polished Aluminum (-AB01) | 1,663 | 1,765 | 1,819 | 1,852 | 1,905 | 1,962 | 2,013 | 2,065 | 2,118 | 2,172 | 2,419 | 2,599 |
| 5694-U  |  Upholstered Back, Polished Aluminum Cantilever Arms 24.5" W x 22" D x 34.5"- 39.5" H Seat: 20.5" W x 18" D Seat Ht: 17" - 22" Back: 18.5" W x 20" H COM: 1.5 yds. COL: 30 sq. ft. 43 lbs. | Black Nylon | 1,582 | 1,684 | 1,738 | 1,771 | 1,824 | 1,881 | 1,932 | 1,984 | 2,037 | 2,091 | 2,338 | 2,518 |
| | | Polished Aluminum (-AB01) | 1,697 | 1,799 | 1,853 | 1,886 | 1,939 | 1,996 | 2,047 | 2,099 | 2,152 | 2,206 | 2,453 | 2,633 |

Note:
For two-tone upholstery, COM requirements are .75 yd. for seat and 1 yd. for back.

OPTIONS

| | | | | | |
|-------|--|-------|---------|---------------------------------|-------|
| -FP01 | Fully Polished Arms (no arm cap) (5694-U model only) | \$80 | -STC02 | Soft Tread Casters | \$33 |
| -SS01 | Seat Slider | \$102 | -STLC02 | Soft Tread Self-Locking Casters | \$63 |
| -WA01 | Width Adjustable Arms | \$38 | -GD04 | Glides | \$30 |
| -PV01 | Pivot Arms | \$71 | -J01 | Jury Base (black only) | \$199 |

* Stool models feature non-tilting mechanism.

 = Available on quick-ship program.



All shipments for this series will be cartoned as standard. If blanket-wrapped shipping is required, please contact client services for additional information.

MEMENTO TASK

Task Intensive Mechanism

ORDERING REQUIREMENTS:

- Model number
- Base finish
- Upholstery selection
- Options, as applicable

| MODEL | PRODUCT SPECIFICATIONS | BASE FINISH | FABRIC GRADES | | | | | | | | LEATHER | | | |
|--|--|---------------------------|---------------|-------|-------|-------|-------|-------|----------|-------|---------|-------|-------|-------|
| | | | COM | A | 1 | 2 | 3 | 4 | COL 5 | 6 | 7 | 8 | L1 | L2 |
| 5641-C  | Upholstered Channel Back, Armless 20" W x 22" D x 34.5"- 39.5" H Seat: 20.5" W x 18" D Seat Ht: 17" - 22" Back: 18.5" W x 20" H COM: 1.5 yds. COL: 30 sq. ft. 44 lbs. | Black Nylon | 1,515 | 1,617 | 1,671 | 1,704 | 1,757 | 1,814 | 1,865 | 1,917 | 1,970 | 2,024 | 2,271 | 2,451 |
| | | Polished Aluminum (-AB01) | 1,630 | 1,732 | 1,786 | 1,819 | 1,872 | 1,929 | 1,980 | 2,032 | 2,085 | 2,139 | 2,386 | 2,566 |
| 5643-C  | Upholstered Channel Back, Adjustable T-Arms 27" W x 22" D x 34.5"- 39.5" H Seat: 20.5" W x 18" D Seat Ht: 17" - 22" Back: 18.5" W x 20" H COM: 1.5 yds. COL: 30 sq. ft. 50 lbs. | Black Nylon | 1,733 | 1,835 | 1,889 | 1,922 | 1,975 | 2,032 | 2,083 | 2,135 | 2,188 | 2,242 | 2,489 | 2,669 |
| | | Polished Aluminum (-AB01) | 1,848 | 1,950 | 2,004 | 2,037 | 2,090 | 2,147 | 2,198 | 2,250 | 2,303 | 2,357 | 2,604 | 2,784 |
| 5644-C  | Upholstered Channel Back, Polished Aluminum Cantilever Arms 24.5" W x 22" D x 34.5"- 39.5" H Seat: 20.5" W x 18" D Seat Ht: 17" - 22" Back: 18.5" W x 20" H COM: 1.5 yds. COL: 30 sq. ft. 50 lbs. | Black Nylon | 1,767 | 1,869 | 1,923 | 1,956 | 2,009 | 2,066 | 2,117 | 2,169 | 2,222 | 2,276 | 2,523 | 2,703 |
| | | Polished Aluminum (-AB01) | 1,882 | 1,984 | 2,038 | 2,071 | 2,124 | 2,181 | 2,232 | 2,284 | 2,337 | 2,391 | 2,638 | 2,818 |

Note:
For two-tone upholstery, COM requirements are .75 yd. for seat and 1 yd. for back.

OPTIONS

| | | | | | |
|--------|--|-------|---------|---------------------------------|-------|
| -FP01 | Fully Polished Arms (no arm cap) (5644-C model only) | \$80 | -STLC02 | Soft Tread Self-Locking Casters | \$63 |
| -SS01 | Seat Slider | \$102 | -GD04 | Glides | \$30 |
| -WA01 | Width Adjustable Arms | \$38 | -J01 | Jury Base (black only) | \$199 |
| -PV01 | Pivot Arms | \$71 | | | |
| -STC02 | Soft Tread Casters | \$33 | | | |



All shipments for this series will be cartoned as standard. If blanket-wrapped shipping is required, please contact client services for additional information.

MEMENTO TASK

Swivel-Tilt with Tilt Lock Mechanism

ORDERING REQUIREMENTS:

- Model number
- Base finish
- Upholstery selection
- Options, as applicable

| MODEL | PRODUCT SPECIFICATIONS | BASE FINISH | FABRIC GRADES | | | | | | | | LEATHER | | | |
|--|--|---------------------------|---------------|-------|-------|-------|-------|-------|-------|-------|---------|-------|-------|-------|
| | | | COM | A | 1 | 2 | 3 | 4 | COL 5 | 6 | 7 | 8 | L1 | L2 |
| 5651-C  | Upholstered Channel Back, Armless 20" W x 22" D x 34.5"- 39.5" H Seat: 20.5" W x 18" D Seat Ht: 17" - 22" Back: 18.5" W x 20" H COM: 1.5 yds. COL: 30 sq. ft. 36 lbs. | Black Nylon | 1,438 | 1,540 | 1,594 | 1,627 | 1,680 | 1,737 | 1,788 | 1,840 | 1,893 | 1,947 | 2,194 | 2,374 |
| | | Polished Aluminum (-AB01) | 1,553 | 1,655 | 1,709 | 1,742 | 1,795 | 1,852 | 1,903 | 1,955 | 2,008 | 2,062 | 2,309 | 2,489 |
| 5653-C  | Upholstered Channel Back, Adjustable T-Arms 27" W x 22" D x 34.5"- 39.5" H Seat: 20.5" W x 18" D Seat Ht: 17" - 22" Back: 18.5" W x 20" H COM: 1.5 yds. COL: 30 sq. ft. 42 lbs. | Black Nylon | 1,656 | 1,758 | 1,812 | 1,845 | 1,898 | 1,955 | 2,006 | 2,058 | 2,111 | 2,165 | 2,412 | 2,592 |
| | | Polished Aluminum (-AB01) | 1,771 | 1,873 | 1,927 | 1,960 | 2,013 | 2,070 | 2,121 | 2,173 | 2,226 | 2,280 | 2,527 | 2,707 |
| 5654-C  | Upholstered Channel Back, Polished Aluminum Cantilever Arms 24.5" W x 22" D x 34.5"- 39.5" H Seat: 20.5" W x 18" D Seat Ht: 17" - 22" Back: 18.5" W x 20" H COM: 1.5 yds. COL: 30 sq. ft. 42 lbs. | Black Nylon | 1,690 | 1,792 | 1,846 | 1,879 | 1,932 | 1,989 | 2,040 | 2,092 | 2,145 | 2,199 | 2,446 | 2,626 |
| | | Polished Aluminum (-AB01) | 1,805 | 1,907 | 1,961 | 1,994 | 2,047 | 2,104 | 2,155 | 2,207 | 2,260 | 2,314 | 2,561 | 2,741 |

Note:
For two-tone upholstery, COM requirements are .75 yd. for seat and 1 yd. for back.

OPTIONS

| | | | | | |
|--------|--|-------|---------|---------------------------------|-------|
| -FP01 | Fully Polished Arms (no arm cap) (5654-C model only) | \$80 | -STLC02 | Soft Tread Self-Locking Casters | \$63 |
| -SS01 | Seat Slider | \$102 | -GD04 | Glides | \$30 |
| -WA01 | Width Adjustable Arms | \$38 | -SK01 | Stool Kit ¹ | \$120 |
| -PV01 | Pivot Arms | \$71 | -J01 | Jury Base (black only) | \$199 |
| -STC02 | Soft Tread Casters | \$33 | | | |

¹ Stool models feature non-tilting mechanism.



All shipments for this series will be cartoned as standard. If blanket-wrapped shipping is required, please contact client services for additional information.

MEMENTO TASK

Synchro-Tilt Mechanism

ORDERING REQUIREMENTS:

- Model number
- Base finish
- Upholstery selection
- Options, as applicable

| MODEL | PRODUCT SPECIFICATIONS | BASE FINISH | FABRIC GRADES | | | | | | | | LEATHER | | | |
|--|--|---------------------------|---------------|-------|-------|-------|-------|-------|-------|-------|---------|-------|-------|-------|
| | | | COM | A | 1 | 2 | 3 | 4 | COL 5 | 6 | 7 | 8 | L1 | L2 |
| 5691-C  | Upholstered Channel Back, Armless 20" W x 22" D x 34.5"- 39.5" H Seat: 20.5" W x 18" D Seat Ht: 17" - 22" Back: 18.5" W x 20" H COM: 1.5 yds. COL: 30 sq. ft. 37 lbs. | Black Nylon | 1,500 | 1,602 | 1,656 | 1,689 | 1,742 | 1,799 | 1,850 | 1,902 | 1,955 | 2,009 | 2,256 | 2,436 |
| | | Polished Aluminum (-AB01) | 1,615 | 1,717 | 1,771 | 1,804 | 1,857 | 1,914 | 1,965 | 2,017 | 2,070 | 2,124 | 2,371 | 2,551 |
| 5693-C  | Upholstered Channel Back, Adjustable T-Arms 27" W x 22" D x 34.5"- 39.5" H Seat: 20.5" W x 18" D Seat Ht: 17" - 22" Back: 18.5" W x 20" H COM: 1.5 yds. COL: 30 sq. ft. 43 lbs. | Black Nylon | 1,718 | 1,820 | 1,874 | 1,907 | 1,960 | 2,017 | 2,068 | 2,120 | 2,173 | 2,227 | 2,474 | 2,654 |
| | | Polished Aluminum (-AB01) | 1,833 | 1,935 | 1,989 | 2,022 | 2,075 | 2,132 | 2,183 | 2,235 | 2,288 | 2,342 | 2,589 | 2,769 |
| 5694-C  | Upholstered Channel Back, Polished Aluminum Cantilever Arms 24.5" W x 22" D x 34.5"- 39.5" H Seat: 20.5" W x 18" D Seat Ht: 17" - 22" Back: 18.5" W x 20" H COM: 1.5 yds. COL: 30 sq. ft. 43 lbs. | Black Nylon | 1,752 | 1,854 | 1,908 | 1,941 | 1,994 | 2,051 | 2,102 | 2,154 | 2,207 | 2,261 | 2,508 | 2,688 |
| | | Polished Aluminum (-AB01) | 1,867 | 1,969 | 2,023 | 2,056 | 2,109 | 2,166 | 2,217 | 2,269 | 2,322 | 2,376 | 2,623 | 2,803 |

Note:
For two-tone upholstery, COM requirements are .75 yd. for seat and 1 yd. for back.

OPTIONS

| | | | | | |
|-------|--|-------|---------|---------------------------------|-------|
| -FP01 | Fully Polished Arms (no arm cap) (5694-C model only) | \$80 | -STC02 | Soft Tread Casters | \$33 |
| -SS01 | Seat Slider | \$102 | -STLC02 | Soft Tread Self-Locking Casters | \$63 |
| -WA01 | Width Adjustable Arms | \$38 | -GD04 | Glides | \$30 |
| -PV01 | Pivot Arms | \$71 | -J01 | Jury Base (black only) | \$199 |

MOZIE GUEST



SPECIFICATIONS:

- Arm and armless models with open upholstered back.
- Arms feature black finish as standard.
- Silver arm finish also available. Please specify (-SA01) after model number and add \$32 list.
- Elliptical tubular steel frame.
- Frame available in standard and premium finishes. See below for options.
- Available with glides or on casters.
- Single guest chairs with glides or casters stack up to 4 high standing or 5 with dolly.
- Dolly not recommended for caster models.
- Guest chairs feature 400 lb. weight capacity.
- Bariatric models feature enhanced seat and back size and 750 lb. weight capacity.
- Optional ganging bracket available for chair to chair connection.
- Please note that to gang two chairs together, separate ganging brackets must be ordered for each unit.
- Ganging brackets fold under seat when not in use.
- If cartoning is required, chairs are packaged in units of two (2). A \$20 List carton break charge will be applied for orders with only one chair.
- All dimensions are nominal.
- Refer to terms and conditions for general information regarding fabrics, finishes, warranty, freight, complete condition of sales and more.

STANDARD METAL BASE FINISH COLORS:

- 0405 Charcoal Grey
- 0535 Metallic Silver
- 0630 Satin Black

PREMIUM METAL BASE FINISH COLORS:





- 0605 Matte Black
- 0705 Matte Cotton
- 0788 Glossy Cotton
- 0805 Oasis
- 0905 Mint
- 1005 Mercury
- 1105 Canary
- 1205 Stone
- 1305 Sage
- 1405 Ice Blue
- 1505 Clay

All shipments for this series will be blanket-wrapped as standard. For customers located in Territory 1 who require cartoning, a 5% upcharge will be added to each product. Please contact client services for additional information.

MOZIE GUEST

ORDERING REQUIREMENTS:

- Model number
- Arm finish
- Frame finish
- Upholstery selection
- Options, as applicable

| MODEL | PRODUCT SPECIFICATIONS | FABRIC GRADES | | | | | | | | LEATHER | | | |
|---|---|---------------|-----|-----|-----|-------|-------|----------|-------|---------|-------|-------|-------|
| | | COM | A | 1 | 2 | 3 | 4 | COL 5 | 6 | 7 | 8 | L1 | L2 |
| 2715  |  Guest Chair, Arms, Casters 24" W x 25" D x 32" H Seat: 19.5" W x 18" D Seat Ht: 18" Arm Ht: 25.5" COM: 1.5 yds. COL: 30 sq. ft. 28 lbs. | 810 | 912 | 966 | 999 | 1,052 | 1,109 | 1,160 | 1,212 | 1,265 | 1,319 | 1,566 | 1,746 |
| 2735  |  Guest Chair, Armless, Casters 21.5" W x 25" D x 32" H Seat: 19.5" W x 18" D Seat Ht: 18" COM: 1.5 yds. COL: 30 sq. ft. 26 lbs. | 740 | 842 | 896 | 929 | 982 | 1,039 | 1,090 | 1,142 | 1,195 | 1,249 | 1,496 | 1,676 |

OPTIONS

| | | | | | |
|--------|-------------------------------|-------|-------|------------------------------|------|
| -PFM02 | Premium Metal Frame Finish | \$101 | -EF01 | 1" Additional Seat Foam | \$44 |
| -SA01 | Silver Arms | \$32 | -MB01 | Moisture Barrier (seat only) | \$68 |
| -STC02 | Soft Tread Casters | \$33 | | | |
| -GC05 | Ganging Connector (per chair) | \$42 | | | |





 = Available on quick-ship program (0535 Metallic Silver base finish only).

All shipments for this series will be blanket-wrapped as standard. For customers located in Territory 1 who require cartoning, a 5% upcharge will be added to each product. Please contact client services for additional information.

MOZIE GUEST

ORDERING REQUIREMENTS:

- Model number
- Arm finish
- Frame finish
- Upholstery selection
- Options, as applicable

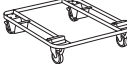
| MODEL | PRODUCT SPECIFICATIONS | FABRIC GRADES | | | | | | | | LEATHER | | | |
|--|--|---------------|-----|-----|-----|-------|-------|----------|-------|---------|-------|-------|-------|
| | | COM | A | 1 | 2 | 3 | 4 | COL 5 | 6 | 7 | 8 | L1 | L2 |
| 2710  |  Guest Chair, Arms, Glides 24" W x 25" D x 32" H Seat: 19.5" W x 18" D Seat Ht: 18" Arm Ht: 25.5" COM: 1.5 yds. COL: 30 sq. ft. 28 lbs. | 804 | 906 | 960 | 993 | 1,046 | 1,103 | 1,154 | 1,206 | 1,259 | 1,313 | 1,560 | 1,740 |
| 2730  |  Guest Chair, Armless, Glides 21.5" W x 25" D x 32" H Seat: 19.5" W x 18" D Seat Ht: 18" COM: 1.5 yds. COL: 30 sq. ft. 26 lbs. | 734 | 836 | 890 | 923 | 976 | 1,033 | 1,084 | 1,136 | 1,189 | 1,243 | 1,490 | 1,670 |
| 2500  | Dolly (Black Finish Only) 24" W x 30" D x 6" H Weight: 37 lbs. | 457 | | | | | | | | | | | |

OPTIONS

| | | | | | |
|--------|-------------------------------|-------|-------|------------------------------|------|
| -PFM02 | Premium Metal Frame Finish | \$101 | -MB01 | Moisture Barrier (seat only) | \$68 |
| -SA01 | Silver Arms | \$32 | -WS | Wall-Saver Leg | n/c |
| -GC05 | Ganging Connector (per chair) | \$42 | | | |
| -EF01 | 1" Additional Seat Foam | \$44 | | | |

 = Available on quick-ship program (0535 Metallic Silver base finish only).

All shipments for this series will be blanket-wrapped as standard. For customers located in Territory 1 who require cartoning, a 5% upcharge will be added to each product. Please contact client services for additional information.

MOZIE GUEST

ORDERING REQUIREMENTS:

- Model number
- Arm finish
- Frame finish
- Upholstery selection
- Options, as applicable

| MODEL | PRODUCT SPECIFICATIONS | FABRIC GRADES | | | | | | | | LEATHER | | | |
|--|---|---------------|-------|-------|-------|-------|-------|----------|-------|---------|-------|-------|-------|
| | | COM | A | 1 | 2 | 3 | 4 | COL 5 | 6 | 7 | 8 | L1 | L2 |
| 2780  | Bariatric Chair, Arms, Glides 34.5" W x 26" D x 33" H Seat: 30" W x 18" D Seat Ht: 19" Arm Ht: 26.5" COM: 2.25 yds. COL: 45 sq. ft. 55 lbs. | 1,276 | 1,429 | 1,510 | 1,560 | 1,639 | 1,724 | 1,801 | 1,879 | 1,958 | 2,039 | 2,410 | 2,680 |

OPTIONS

| | | |
|--------|------------------------------|-------|
| -PFM02 | Premium Metal Frame Finish | \$101 |
| -SA01 | Silver Arms | \$32 |
| -EF02 | 1" Additional Seat Foam | \$98 |
| -MB02 | Moisture Barrier (seat only) | \$89 |
| -WS | Wall-Saver Leg | n/c |

MOZIE GUEST

UPHOLSTERY COMBINATIONS:

- For upholstery combinations, refer to the pricing below.
- When combining two COM/COV/COL fabrics, or fabrics with the same grade, add \$120 List per unit.
- When combining three or more COM/COV/COL fabrics, or fabrics with the same grade, add \$150 List per unit.
- When combining different grades of fabric, price will be based on the highest grade specified.
- Two-tone upholstery examples and yardage requirements for the most common combinations are listed below. Additional combinations available; please contact client services for yardage requirements and pricing.
- Note: Yardage amounts are based on fabric which is plain (i.e. non-directional) and a full 54" wide.
- Appropriate upholstery code must be included.



| Code | MO1 |
|--------------|------------------------|
| <u>Model</u> | <u>COM Requirement</u> |
| 2710 | Seat = 1 yd. |
| 2715 | Back = 1 yd. |
| 2730 | |
| 2735 | |

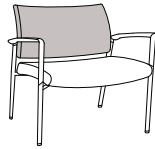

| Code | MO2 |
|--------------|------------------------|
| <u>Model</u> | <u>COM Requirement</u> |
| 2780 | Seat = 1.25 yds. |
| | Back = 1.25 yds. |

MOZIE OCCASIONAL TABLES



SPECIFICATIONS:

- Square and rectangular top shapes.
- Laminate and solid surface top material options.
- Laminate tops are ¾" thick, solid surface tops are ½" thick.
- Laminate available in all standard colors.
- For custom laminate options, add \$649 List per color per order. Pre-approval required, please contact client services.
- Solid surface available in white only.
- Self edge standard.
- Round metal legs available in standard and premium finishes. Refer to options below.
- Apron will match leg finish unless specified otherwise.
- All dimensions are nominal.
- Refer to terms and conditions for general information regarding fabrics, finishes, warranty, freight, complete condition of sales and more.

STANDARD METAL BASE FINISH COLORS:

- 0405 Charcoal Grey
- 0535 Metallic Silver
- 0630 Satin Black

PREMIUM METAL BASE FINISH COLORS:

- 0605 Matte Black
- 0705 Matte Cotton
- 0788 Glossy Cotton
- 0805 Oasis
- 0905 Mint
- 1005 Mercury
- 1105 Canary
- 1205 Stone
- 1305 Sage
- 1405 Ice Blue
- 1505 Clay

All shipments for this series will be blanket-wrapped as standard. For customers located in Territory 1 who require cartoning, a 5% upcharge will be added to each product. Please contact client services for additional information.

MOZIE OCCASIONAL TABLES

ORDERING REQUIREMENTS:

- Model number
- Top surface material
- Top finish, as applicable
- PVC edge color, as applicable
- Leg finish
- Options, as applicable

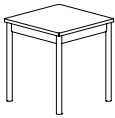
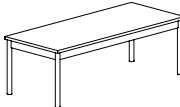
| | MODEL | DIMENSIONS | LAMINATE TOP (-L) | SOLID SURFACE TOP (-SF) | WEIGHT |
|---|--------------------------|-----------------------|-------------------|-------------------------|---------|
|  | Square Table | | | | |
| | 270-181820-() | 18" W x 18" D x 20" H | 985 | 1,172 | 16 lbs. |
| | 270-222220-() | 22" W x 22" D x 20" H | 1,085 | 1,417 | 20 lbs. |
| | 270-303020-() | 30" W x 30" D x 20" H | 1,363 | 2,057 | 25 lbs. |
|  | Rectangular Table | | | | |
| | 270-482016-() | 48" W x 20" D x 16" H | 1,481 | 2,221 | 36 lbs. |

OPTIONS

-PFM02 Premium Metal Leg Finish \$101

All shipments for this series will be blanket-wrapped as standard. For customers located in Territory 1 who require cartoning, a 5% upcharge will be added to each product. Please contact client services for additional information.

OUTSET OCCASIONAL TABLES | Designed by Chris & Jon Panichella



SPECIFICATIONS:

- Tops offered in Ash and Walnut veneer as well as laminate, Fenix and solid surface.
- All standard and custom wood finishes available.
- For veneer, edge finish will always match the top finish color, unless otherwise specified.
- For wood grain and solid black laminates, as well as Fenix Nero Ingo (black), edge will match the top color, unless otherwise specified.
- For all other solid color laminates and Fenix, edge finish will be natural (clear coat) as standard, unless otherwise specified.
- Edges are also available in all standard wood finishes, please specify. For custom edge finishes (e.g. to match standard solid color laminates), please add one-time upcharge of \$531 List per color, per order.
- For custom wood finishes, please contact client services and add one-time upcharge of \$531 List per color per order.
- For Alabaster and Super Matte Sable Ash, premium wood finish upcharge applies. Refer to options section for pricing.
- For custom laminate options, add \$649 List per color per order. Pre-approval required, please contact client services.
- Fenix offered in five standard colorways.
- For non-standard Fenix colors, please contact client services for pricing.
- Solid surface available in white only.
- 5/8" diameter metal rod base available in standard and premium finishes. Please refer to listing below.
- Standard with adjustable glides.
- All dimensions are nominal.
- Refer to terms and conditions for general information regarding finishes, warranty, freight, complete condition of sales and more.

FENIX COLORS:

- Bianco Kos
- Nero Ingo
- Grigio Efeso
- Grigio Londra
- Grigio Bromo

STANDARD METAL BASE FINISH COLORS:

- 0405 Charcoal Grey
- 0535 Metallic Silver
- 0630 Satin Black

PREMIUM METAL BASE FINISH COLORS:



- 0605 Matte Black
- 0705 Matte Cotton
- 0788 Glossy Cotton
- 0805 Oasis
- 0905 Mint
- 1005 Mercury
- 1105 Canary
- 1205 Stone
- 1305 Sage
- 1405 Ice Blue
- 1505 Clay

All shipments for this series will be blanket-wrapped as standard. For customers located in Territory 1 who require cartoning, a 5% upcharge will be added to each product. Please contact client services for additional information.

OUTSET OCCASIONAL TABLES | Designed by Chris & Jon Panichella

ORDERING REQUIREMENTS:

- Model number
- Top surface material
- Top finish, as applicable
- Base finish
- Options, as applicable

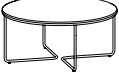
| MODEL | DIMENSIONS | VEENER TOP (-V) | LAMINATE TOP (-L) | FENIX TOP (-FE) | SOLID SURFACE TOP (-SF) | WEIGHT |
|---|---|-----------------|-------------------|-----------------|-------------------------|---------|
|  |  Round Tables 9500-2120-() 21" Dia. x 20" H | 1,095 | 991 | 1,387 | 1,246 | 14 lbs. |
| | 9500-2916-() 29" Dia. x 16" H | 1,382 | 1,226 | 1,980 | 1,711 | 20 lbs. |
| | 9500-3616-() 36" Dia. x 16" H | 1,888 | 1,575 | 2,989 | 2,574 | 26 lbs. |
|  | | | | | | |

OPTIONS

- PFM02 Premium Metal Base Finish \$101
- PFW02 Premium Wood Top Finish \$23

 = Available on quick-ship program (all tops with standard base finishes only).

All shipments for this series will be blanket-wrapped as standard. For customers located in Territory 1 who require cartoning, a 5% upcharge will be added to each product. Please contact client services for additional information.

PEPA GUEST | Designed by Gemma Bernal



SPECIFICATIONS:

- Fully upholstered arm and armless models.
- 3/4" diameter, 14 gauge round tubular steel frame.
- Frame available in standard and premium finishes. See below for options.
- For custom finish colors, please contact client services for pricing.
- All models feature wall-saver leg design.
- Chairs stack up to 4 high standing or 6 with dolly.
- If cartoning is required, chairs are packaged in units of three (3). A \$20 List carton break charge will be applied for orders with only one or two chairs.
- 275 lb. weight capacity.
- Refer to terms and conditions for general information regarding fabrics, finishes, warranty, freight, complete condition of sales and more.
- All dimensions are nominal.

STANDARD METAL FRAME FINISH COLORS:

- 0405 Charcoal Grey
- 0535 Metallic Silver
- 0630 Satin Black

PREMIUM METAL FRAME FINISH COLORS:



- 0605 Matte Black
- 0705 Matte Cotton
- 0788 Glossy Cotton
- 0805 Oasis
- 0905 Mint
- 1005 Mercury
- 1105 Canary
- 1205 Stone
- 1305 Sage
- 1405 Ice Blue
- 1505 Clay

All shipments for this series will be blanket-wrapped as standard. For customers located in Territory 1 who require cartoning, a 5% upcharge will be added to each product. Please contact client services for additional information.

PEPA GUEST | Designed by Gemma Bernal

ORDERING REQUIREMENTS:

- Model number
- Frame finish
- Upholstery selection
- Options, as applicable

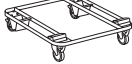
| MODEL | PRODUCT SPECIFICATIONS | FABRIC GRADES | | | | | | | | LEATHER | | | |
|--|--|---------------|-----|-----|-----|-----|-----|----------|-------|---------|-------|-------|-------|
| | | COM | A | 1 | 2 | 3 | 4 | COL 5 | 6 | 7 | 8 | L1 | L2 |
| 9401  | Guest Chair, Arms, Glides 20" W x 22.5" D x 32.75" H Seat: 18.5" W x 18" D Seat Ht: 18" Arm Ht: 27" COM: 1 yd. COL: 20 sq. ft. 20 lbs. | 798 | 866 | 902 | 924 | 959 | 997 | 1,031 | 1,066 | 1,101 | 1,137 | 1,302 | 1,422 |
| 9402  | Guest Chair, Armless, Glides 18" W x 22.5" D x 32.75" H Seat: 18.5" W x 18" D Seat Ht: 18" COM: 1 yd. COL: 20 sq. ft. 17 lbs. | 777 | 845 | 881 | 903 | 938 | 976 | 1,010 | 1,045 | 1,080 | 1,116 | 1,281 | 1,401 |
| 9400  | Dolly (Black Finish Only) 24" W x 30" D x 6" H 20 lbs. | 648 | | | | | | | | | | | |

OPTIONS

- PF02 Premium Metal Frame Finish \$101
- MB01 Moisture Barrier (seat only) \$68
- VCT04 VCT Tile Glides \$28

All shipments for this series will be blanket-wrapped as standard. For customers located in Territory 1 who require cartoning, a 5% upcharge will be added to each product. Please contact client services for additional information.

PEPA GUEST | Designed by Gemma Bernal

UPHOLSTERY COMBINATIONS:

- For upholstery combinations, refer to the pricing below.
- When combining two COM/COV/COL fabrics, or fabrics with the same grade, add \$120 List per unit.
- When combining three or more COM/COV/COL fabrics, or fabrics with the same grade, add \$150 List per unit.
- When combining different grades of fabric, price will be based on the highest grade specified.
- Two-tone upholstery examples and yardage requirements for the most common combinations are listed below. Additional combinations available; please contact client services for yardage requirements and pricing.
- Note: Yardage amounts are based on fabric which is plain (i.e. non-directional) and a full 54" wide.
- Appropriate upholstery code must be included.



| | |
|--------------|----------------------------------|
| Code | PE1 |
| <u>Model</u> | <u>COM Requirement</u> |
| All Models | Seat = .75 yd. Back = .75 yd. |

All shipments for this series will be blanket-wrapped as standard. For customers located in Territory 1 who require cartoning, a 5% upcharge will be added to each product. Please contact client services for additional information.

PIXIE STOOLS | Designed by Qdesign



SPECIFICATIONS:

- 30" height with triangular seat.
- ½" diameter steel rod frame.
- Frame available in standard and premium finishes. Please refer to listing below.
- For custom finish colors, please contact client services for pricing.
- 350 lb. weight capacity.
- Optional clear glides for hard surface flooring.
- All dimensions are nominal.
- Refer to terms and conditions for general information regarding fabrics, finishes, warranty, freight, complete condition of sales and more.

STANDARD METAL FRAME FINISH COLORS:

- 0405 Charcoal Grey
- 0535 Metallic Silver
- 0199 Chrome
- 0630 Satin Black

PREMIUM METAL FRAME FINISH COLORS:



- 0605 Matte Black
- 0705 Matte Cotton
- 0788 Glossy Cotton
- 0805 Oasis
- 0905 Mint
- 1005 Mercury
- 1105 Canary
- 1205 Stone
- 1305 Sage
- 1405 Ice Blue
- 1505 Clay

All shipments for this series will be blanket-wrapped as standard. For customers located in Territory 1 who require cartoning, a 5% upcharge will be added to each product. Please contact client services for additional information.

PIXIE STOOLS | Designed by Qdesign

ORDERING REQUIREMENTS:

- Model number
- Frame finish
- Upholstery selection
- Options, as applicable

| MODEL | PRODUCT SPECIFICATIONS | FABRIC GRADES | | | | | | | | | | LEATHER | |
|---|--|---------------|-----|-----|-----|-----|-----|----------|-----|-----|-----|---------|-----|
| | | COM | A | 1 | 2 | 3 | 4 | COL 5 | 6 | 7 | 8 | L1 | L2 |
| 1020-30  |  30" Bar-Height Stool 18.5" W x 15.5" D x 31" H Seat: 14" W x 13.25" D Seat Ht: 31" COM: .5 yd. COL: 10 sq. ft. 12 lbs. | 682 | 716 | 734 | 745 | 763 | 782 | 799 | 816 | 834 | 852 | 934 | 994 |

OPTIONS

- PFM02 Premium Metal Frame Finish \$101
- CG03 Clear Glides (set of 6) \$17

 = Available on quick-ship program (0535 Metallic Silver or 0199 Chrome base finishes only).

All shipments for this series will be blanket-wrapped as standard. For customers located in Territory 1 who require cartoning, a 5% upcharge will be added to each product. Please contact client services for additional information.

PLAYGROUND OCCASIONAL TABLES | Designed by Chris Panichella



SPECIFICATIONS:

- Round, square and rectangular top shapes.
- Wood veneer and laminate top surface options.
- Three wood species available: Beech, White Oak and Walnut.
- For custom wood finishes, please contact client services and add one-time upcharge of \$531 List per color per order.
- Premium wood finish upcharge applies to the following wood finishes. Refer to option section for pricing.
 - Super Matte Sable Beech
 - Alabaster Oak
 - Super Matte Sable Oak
- For custom laminate options, add \$649 List per color per order. Pre-approval required, please contact client services.
- For standard wood grain laminate or solid black laminate tops, edge will match unless specified otherwise.
- For all other solid laminates, edge will be exposed plywood substrate with clear coat finish.
- Metal legs offered in standard and premium finishes. Please refer to listing below.
- For custom finish colors, please contact client services for pricing.
- Optional 16" diameter fixed second-tier table offered in wood veneer or laminate.
- Second-tier table finish will match table-top finish unless specified otherwise.
- **Please note that second-tier table is only available on round and oval table sizes 29" diameter/width and larger. It is not available on square tables, rectangular tables or round table 7270-2116.**
- All dimensions are nominal.
- Refer to terms and conditions for general information regarding fabrics, finishes, warranty, freight, complete condition of sales and more.

STANDARD METAL LEG FINISH COLORS:

- 0405 Charcoal Grey
- 0535 Metallic Silver
- 0199 Chrome
- 0630 Satin Black

PREMIUM METAL LEG FINISH COLORS:



- 0605 Matte Black
- 0705 Matte Cotton
- 0788 Glossy Cotton
- 0805 Oasis
- 0905 Mint
- 1005 Mercury
- 1105 Canary
- 1205 Stone
- 1305 Sage
- 1405 Ice Blue
- 1505 Clay

All shipments for this series will be blanket-wrapped as standard. For customers located in Territory 1 who require cartoning, a 5% upcharge will be added to each product. Please contact client services for additional information.

PLAYGROUND OCCASIONAL TABLES | Designed by Chris Panichella

ORDERING REQUIREMENTS:

- Model number
- Top surface material
- Top finish
- Leg finish
- Options, as applicable

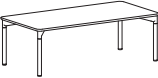
| | MODEL | DIMENSIONS | WOOD (-V) OR LAMINATE (-L) TOP | WEIGHT |
|---|--------------------------|-----------------------|--------------------------------|---------|
|  | Round Table | | | |
| | 7270-2116-() | 21" Dia. x 16" H | 1,016 | 15 lbs. |
| | 7270-2916-() | 29" Dia. x 16" H | 1,501 | 21 lbs. |
| | 7270-3616-() | 36" Dia. x 16" H | 1,887 | 28 lbs. |
| | 7270-4216-() | 42" Dia. x 16" H | 1,967 | 33 lbs. |
|  | Oval Table | | | |
| | 7275-362416-() | 36" W x 24" D x 16" H | 1,500 | 26 lbs. |
| | 7275-462416-() | 46" W x 24" D x 16" H | 1,731 | 22 lbs. |
|  | Square Table | | | |
| | 7280-222216-() | 22" W x 22" D x 16" H | 1,016 | 26 lbs. |
| | 7280-303016-() | 30" W x 30" D x 16" H | 1,501 | 22 lbs. |
| | 7280-363616-() | 36" W x 36" D x 16" H | 1,887 | 28 lbs. |
| | 7280-424216-() | 42" W x 42" D x 16" H | 1,967 | 33 lbs. |
|  | Rectangular Table | | | |
| 7280-482416-() | 48" W x 24" D x 16" H | 1,731 | 34 lbs. | |

OPTIONS

| | | |
|----------|----------------------------|-------|
| -PFM02 | Premium Metal Leg Finish | \$101 |
| -PFW04 | Premium Wood Finish* | \$46 |
| -NSO4 | Non-Skid Glides | \$26 |
| -STX02-W | Wood Second-Tier Table | \$527 |
| -STX02-L | Laminate Second-Tier Table | \$527 |

*Second-tier table, if specified, will match as standard with no additional upcharge.

All shipments for this series will be blanket-wrapped as standard. For customers located in Territory 1 who require cartoning, a 5% upcharge will be added to each product. Please contact client services for additional information.

PLAYGROUND MODULAR | Designed by Chris Panichella



SPECIFICATIONS:

- Metal frame available in standard and premium finishes. See following pages for options.
- For custom metal finish colors, please contact client services for pricing.
- Optional power units available for placement under seating units.
- Multiple bench sizes and shapes offered with or without backrest, available individually or in modular combinations.
- Optional ganging connector offered for modular configurations. Please specify "GCO7" with quantity and add \$66 List per set.
- Single seat benches feature 350 lb. weight capacity.
- Two-seat benches feature 600 lb. weight capacity.
- Please include layout drawings or sketch with each modular order.
- All dimensions are nominal.
- Refer to terms and conditions for general information regarding fabrics, finishes, warranty, freight, complete condition of sales and more.

ROTATING TABLET:

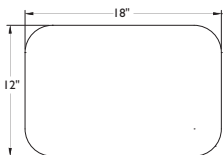

- Available on select modular bench units.
- Tablet size is 18" W x 12" D x .75" thick and features 360-degree turning radius.
- Two tablet surface options: wood veneer and laminate.
- Three wood species available: Beech, White Oak and Walnut.
- For custom wood finishes, please contact client services and add one-time upcharge of \$531 List per color per order.
- Premium wood finish upcharge applies to the following wood finishes. Refer to option section for pricing.
 - Super Matte Sable Beech
 - Alabaster Oak
 - Super Matte Sable Oak
- For custom laminate options, add \$649 List per color per order. Pre-approval required, please contact client services.
- For standard wood grain laminate or solid black laminate tops, edge will match unless specified otherwise.
- For all other solid laminates, edge will be exposed plywood substrate with clear coat finish.
- Tablet mounting post will match frame/leg finish unless specified otherwise.
- Please note that tablet is not available on modular corner units due to space limitations.

PLAYGROUND MODULAR | Designed by Chris Panichella

STATIONARY TABLE-ETTE:

- Available on select modular bench units.
- Table-ette size is 12" dia. x .75" thick.
- Two table-ette surface options: wood veneer and laminate.
- Three wood species available: Beech, White Oak and Walnut.
- For custom wood finishes, please contact client services and add one-time upcharge of \$531 List per color per order.
- Premium wood finish upcharge applies to the following wood finishes. Refer to option section for pricing.
 - Super Matte Sable Beech
 - Alabaster Oak
 - Super Matte Sable Oak
- For custom laminate options, add \$649 List per color per order. Pre-approval required, please contact client services.
- For standard wood grain laminate or solid black laminate tops, edge will match unless specified otherwise.
- For all other solid laminates, edge will be exposed plywood substrate with clear coat finish.
- Table-ette mounting post will match frame/leg finish unless specified otherwise.
- Please note that center placement for is only available on 56" straight bench and requires the addition of a center leg.
- Table-ette is not available on modular corner units due to space limitations.

STANDARD METAL FRAME FINISH COLORS:

- 0405 Charcoal Grey
- 0535 Metallic Silver
- 0199 Chrome
- 0630 Satin Black

PREMIUM METAL FRAME FINISH COLORS:

- 0605 Matte Black
- 0705 Matte Cotton
- 0788 Glossy Cotton
- 0805 Oasis
- 0905 Mint
- 1005 Mercury
- 1105 Canary
- 1205 Stone
- 1305 Sage
- 1405 Ice Blue
- 1505 Clay

PLAYGROUND MODULAR | Designed by Chris Panichella

MINI-TAP POWER UNITS:

- Available on all models.
- Dimensions: 3" W x 3" D x 1.75" H
- Black and white color options.
- 72" electrical cord (no hardwire option or daisy chain feature available for this series).
- Placement is located under seat and may be affixed to side or front of seating unit. For side placement, unit will be centered. For front placement, please specify left, center or right, as seated.
- UL listed.

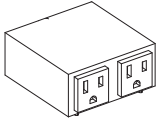

Mini-Tap 2 (MT2)

- Two outlets.

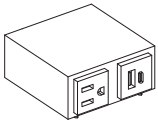

Mini-Tap 3 (MT3)

- One outlet, one USB-A and one USB-C charging port.

FABRIC APPLICATION:

- Fabric is cut "up the roll" as a standard cutting procedure (see example below). If another direction is required (i.e. "railroaded"), please specify and contact client services for yardage requirements.
- Note: Upholstery direction must be specified on corner units when patterned fabrics are selected. In the absence of specific instructions, Encore reserves the right to upholster at our discretion.

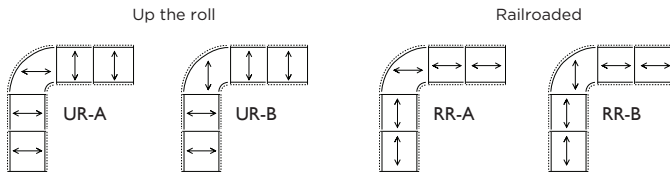

MODULAR ARRANGEMENTS:

- Optional ganging bracket available for modular bench units. Please specify "-GC07" with quantity and add \$66 List per set. One set contains two brackets for connecting two units together.
- Field assembly required.



- Note: Layout drawings or sketch is required with each modular order.

All shipments for this series will be blanket-wrapped as standard. For customers located in Territory 1 who require cartoning, a 5% upcharge will be added to each product. Please contact client services for additional information.

PLAYGROUND MODULAR | Designed by Chris Panichella

ORDERING REQUIREMENTS:

- Model number
- Frame finish
- Upholstery selection
- Options, as applicable

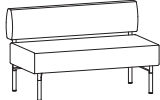
| MODEL | PRODUCT SPECIFICATIONS | FABRIC GRADES | | | | | | | | LEATHER | | | |
|--|--|---------------|-------|-------|-------|-------|-------|----------|-------|---------|-------|-------|-------|
| | | COM | A | 1 | 2 | 3 | 4 | COL 5 | 6 | 7 | 8 | L1 | L2 |
| 7224-BR  | Bench with Backrest 24" Straight 24" W x 26.75" D x 29.5 H" Seat: 24" W x 23" D Seat Ht: 17.5" COM: 1.75 yds. COL: 35 sq. ft. 42 lbs. | 2,036 | 2,155 | 2,218 | 2,257 | 2,318 | 2,385 | 2,444 | 2,505 | 2,567 | 2,630 | 2,918 | 3,128 |
| 7248-BR  | Bench with Backrest 48" Straight 48" W x 26.75" D x 29.5 H" Seat: 48" W x 23" D Seat Ht: 17.5" COM: 3.25 yds. COL: 65 sq. ft. 67 lbs. | 2,859 | 3,080 | 3,197 | 3,269 | 3,383 | 3,506 | 3,617 | 3,730 | 3,844 | 3,961 | 4,497 | 4,887 |

OPTIONS

| | | | | | |
|----------|---|-------|------------|--|-------|
| -PFM02 | Premium Metal Frame Finish | \$101 | -TAR02-() | Rotating Tablet, Right (as seated) | \$593 |
| -MB01 | Moisture Barrier (24" bench) | \$68 | -TAL02-() | Rotating Tablet, Left (as seated) | \$593 |
| -MB02 | Moisture Barrier (48" bench) | \$89 | -STR01-() | Stationary Table-ette, Right (as seated) | \$593 |
| -NS04 | Non-Skid Glides | \$26 | -STL01-() | Stationary Table-ette, Left (as seated) | \$593 |
| -GC07 | Ganging Connector | \$66 | -PFW01 | Premium Wood Finish (tablet/table-ette) | \$12 |
| -MT2-() | Mini-Tap Power Unit (2 power) | \$380 | | | |
| -MT3-() | Mini-Tap Power Unit (1 power, 1 USB-A, 1 USB-C) | \$414 | | | |



Note: Please specify (-B) for black and (-W) for white on Mini-Tap Power Units. Please specify (-W) for wood and (-L) for laminate on Rotating Tablet and Stationary Table-ette.

All shipments for this series will be blanket-wrapped as standard. For customers located in Territory 1 who require cartoning, a 5% upcharge will be added to each product. Please contact client services for additional information.

PLAYGROUND MODULAR | Designed by Chris Panichella

ORDERING REQUIREMENTS:

- Model number
- Frame finish
- Upholstery selection
- Options, as applicable

| MODEL | PRODUCT SPECIFICATIONS | FABRIC GRADES | | | | | | | | LEATHER | | | |
|---|---|---------------|-------|-------|-------|-------|-------|----------|-------|---------|-------|-------|-------|
| | | COM | A | 1 | 2 | 3 | 4 | COL 5 | 6 | 7 | 8 | L1 | L2 |
| 7223-BR-L  | Bench with Backrest Left End Corner Unit 26.75" W x 26.75" D x 29.5" H Seat: 23" W x 23" D Seat Ht: 17.5" COM: 2.25 yds. COL: 45 sq. ft. 45 lbs. | 2,286 | 2,439 | 2,520 | 2,570 | 2,649 | 2,734 | 2,811 | 2,889 | 2,968 | 3,049 | 3,420 | 3,690 |
| 7223-BR-C  | Bench with Backrest Corner Unit 26.75" W x 26.75" D x 29.5" H Seat: 23" W x 23" D Seat Ht: 17.5" COM: 2.25 yds. COL: 45 sq. ft. 45 lbs. | 2,286 | 2,439 | 2,520 | 2,570 | 2,649 | 2,734 | 2,811 | 2,889 | 2,968 | 3,049 | 3,420 | 3,690 |
| 7223-BR-R  | Bench with Backrest Right End Corner Unit 26.75" W x 26.75" D x 29.5" H Seat: 23" W x 23" D Seat Ht: 17.5" COM: 2.25 yds. COL: 45 sq. ft. 45 lbs. | 2,286 | 2,439 | 2,520 | 2,570 | 2,649 | 2,734 | 2,811 | 2,889 | 2,968 | 3,049 | 3,420 | 3,690 |

OPTIONS

| | | |
|---------|---|-------|
| -PFM02 | Premium Metal Frame Finish | \$101 |
| -MB01 | Moisture Barrier (seat only) | \$68 |
| -NS04 | Non-Skid Glides | \$26 |
| -GC07 | Ganging Connector | \$66 |
| -MT2(-) | Mini-Tap Power Unit (2 power) | \$380 |
| -MT3(-) | Mini-Tap Power Unit (1 power, 1 USB-A, 1 USB-C) | \$414 |

Note: Please specify (-B) for black and (-W) for white on Mini-Tap Power Units.

All shipments for this series will be blanket-wrapped as standard. For customers located in Territory 1 who require cartoning, a 5% upcharge will be added to each product. Please contact client services for additional information.

PLAYGROUND MODULAR | Designed by Chris Panichella

ORDERING REQUIREMENTS:

- Model number
- Frame finish
- Upholstery selection
- Options, as applicable

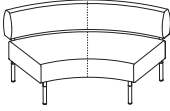
| MODEL | PRODUCT SPECIFICATIONS | FABRIC GRADES | | | | | | | | | | LEATHER | |
|---------|--|---------------|-------|-------|-------|-------|-------|----------|-------|-------|-------|---------|-------|
| | | COM | A | 1 | 2 | 3 | 4 | COL 5 | 6 | 7 | 8 | L1 | L2 |
| 7260-BR |  <p>Bench with Backrest 60-Degree Inside Wedge 61.5" W x 31.25" D x 29.5 H" Seat: 57.5" W x 27.5" D Seat Ht: 17.5" COM: 4.25 yds. COL: 85 sq. ft. 72 lbs.</p> | 3,419 | 3,708 | 3,861 | 3,955 | 4,104 | 4,265 | 4,410 | 4,558 | 4,707 | 4,860 | 5,561 | 6,071 |

OPTIONS

| | | | | | |
|----------|---|-------|------------|--|-------|
| -PFM02 | Premium Metal Frame Finish | \$101 | -TAR02-() | Rotating Tablet, Right (as seated) | \$593 |
| -MB02 | Moisture Barrier (seat only) | \$89 | -TAL02-() | Rotating Tablet, Left (as seated) | \$593 |
| -NS04 | Non-Skid Glides | \$26 | -STR01-() | Stationary Table-ette, Right (as seated) | \$593 |
| -GCO7 | Ganging Connector | \$66 | -STL01-() | Stationary Table-ette, Left (as seated) | \$593 |
| -MT2-() | Mini-Tap Power Unit (2 power) | \$380 | -PFW01 | Premium Wood Finish (tablet/table-ette) | \$12 |
| -MT3-() | Mini-Tap Power Unit (1 power, 1 USB-A, 1 USB-C) | \$414 | | | |



Note: Please specify (-B) for black and (-W) for white on Mini-Tap Power Units. Please specify (-W) for wood and (-L) for laminate on Rotating Tablet and Stationary Table-ette.

All shipments for this series will be blanket-wrapped as standard. For customers located in Territory 1 who require cartoning, a 5% upcharge will be added to each product. Please contact client services for additional information.

PLAYGROUND MODULAR | Designed by Chris Panichella

ORDERING REQUIREMENTS:

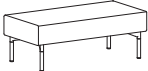
- Model number
- Leg finish
- Upholstery selection
- Options, as applicable

| MODEL | PRODUCT SPECIFICATIONS | FABRIC GRADES | | | | | | | | | | LEATHER | |
|--|--|---------------|-------|-------|-------|-------|-------|----------|-------|-------|-------|---------|-------|
| | | COM | A | 1 | 2 | 3 | 4 | COL 5 | 6 | 7 | 8 | L1 | L2 |
| 7224  | 24" Straight Bench Overall: 24" W x 23" D x 17.5" H COM: 1.25 yds. COL: 25 sq. ft. 33 lbs. | 1,336 | 1,421 | 1,466 | 1,494 | 1,538 | 1,585 | 1,628 | 1,671 | 1,715 | 1,760 | 1,966 | 2,116 |
| 7248  | 48" Straight Bench Overall: 48" W x 23" D x 17.5" H COM: 1.75 yds. COL: 35 sq. ft. 56 lbs. | 1,810 | 1,929 | 1,992 | 2,031 | 2,092 | 2,159 | 2,218 | 2,279 | 2,341 | 2,404 | 2,692 | 2,902 |
| 7256  | 56" Straight Bench Overall: 56" W x 23" D x 17.5" H COM: 2.5 yds. COL: 40 sq. ft. 66 lbs. | 2,121 | 2,291 | 2,381 | 2,436 | 2,524 | 2,619 | 2,704 | 2,791 | 2,879 | 2,969 | 3,381 | 3,681 |

OPTIONS

| | | | | | |
|----------|---|-------|------------|--|-------|
| -PFM02 | Premium Metal Leg Finish | \$101 | -TAR02-() | Rotating Tablet, Right (as seated) | \$593 |
| -MB01 | Moisture Barrier (24" bench) | \$68 | -TAC01-() | Rotating Tablet, Center | \$593 |
| -MB02 | Moisture Barrier (48" & 56" bench) | \$89 | -TAL02-() | Rotating Tablet, Left (as seated) | \$593 |
| -NS04 | Non-Skid Glides | \$26 | -STR01-() | Stationary Table-ette, Right (as seated) | \$593 |
| -GC07 | Ganging Connector | \$66 | -STC02-() | Stationary Table-ette, Center | \$593 |
| -MT2-() | Mini-Tap Power Unit (2 power) | \$414 | -STL01-() | Stationary Table-ette, Left (as seated) | \$593 |
| -MT3-() | Mini-Tap Power Unit (1 power, 1 USB-A, 1 USB-C) | \$380 | -PFW01 | Premium Wood Finish (tablet/table-ette) | \$12 |



Note: Please specify (-B) for black and (-W) for white on Mini-Tap Power Units. Please specify (-W) for wood and (-L) for laminate on Rotating Tablet and Stationary Table-ette.

All shipments for this series will be blanket-wrapped as standard. For customers located in Territory 1 who require cartoning, a 5% upcharge will be added to each product. Please contact client services for additional information.

PLAYGROUND MODULAR | Designed by Chris Panichella

ORDERING REQUIREMENTS:

- Model number
- Leg finish
- Upholstery selection
- Options, as applicable

| MODEL | PRODUCT SPECIFICATIONS | FABRIC GRADES | | | | | | | | LEATHER | | | |
|--|---|---------------|-------|-------|-------|-------|-------|----------|-------|---------|-------|-------|-------|
| | | COM | A | 1 | 2 | 3 | 4 | COL 5 | 6 | 7 | 8 | L1 | L2 |
| 7223-L  | Left End Corner Unit Overall: 23" W x 23" D x 17.5" H COM: 1.25 yds. COL: 25 sq. ft. 36 lbs. | 1,389 | 1,474 | 1,519 | 1,547 | 1,591 | 1,638 | 1,681 | 1,724 | 1,768 | 1,813 | 2,019 | 2,169 |
| 7223-C  | Corner Unit Overall: 23" W x 23" D x 17.5" H COM: 1.25 yds. COL: 25 sq. ft. 36 lbs. | 1,389 | 1,474 | 1,519 | 1,547 | 1,591 | 1,638 | 1,681 | 1,724 | 1,768 | 1,813 | 2,019 | 2,169 |
| 7223-R  | Right End Corner Unit Overall: 23" W x 23" D x 17.5" H COM: 1.25 yds. COL: 25 sq. ft. 36 lbs. | 1,389 | 1,474 | 1,519 | 1,547 | 1,591 | 1,638 | 1,681 | 1,724 | 1,768 | 1,813 | 2,019 | 2,169 |

OPTIONS

| | | |
|---------|---|-------|
| -PFM02 | Premium Metal Frame Finish | \$101 |
| -MB02 | Moisture Barrier (seat only) | \$68 |
| -NS04 | Non-Skid Glides | \$26 |
| -GC07 | Ganging Connector | \$66 |
| -MT2(-) | Mini-Tap Power Unit (2 power) | \$380 |
| -MT3(-) | Mini-Tap Power Unit (1 power, 1 USB-A, 1 USB-C) | \$414 |

Note: Please specify (-B) for black and (-W) for white on Mini-Tap Power Units.

All shipments for this series will be blanket-wrapped as standard. For customers located in Territory 1 who require cartoning, a 5% upcharge will be added to each product. Please contact client services for additional information.

PLAYGROUND MODULAR | Designed by Chris Panichella

ORDERING REQUIREMENTS:

- Model number
- Leg finish
- Upholstery selection
- Options, as applicable

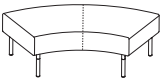
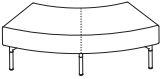
| MODEL | PRODUCT SPECIFICATIONS | FABRIC GRADES | | | | | | | | | | LEATHER | |
|---|--|---------------|-------|-------|-------|-------|-------|----------|-------|-------|-------|---------|-------|
| | | COM | A | 1 | 2 | 3 | 4 | COL 5 | 6 | 7 | 8 | L1 | L2 |
| 7260  | 60-Degree Inside Wedge Bench Overall: 57.75" W x 27.5" D x 17.5" H COM: 2.25 yds. COL: 45 sq. ft. 48 lbs. | 2,270 | 2,423 | 2,504 | 2,554 | 2,633 | 2,718 | 2,795 | 2,873 | 2,952 | 3,033 | 3,404 | 3,674 |
| 7261  | 60-Degree Outside Wedge Bench Overall: 57.75" W x 27.5" D x 17.5" H COM: 2.25 yds. COL: 45 sq. ft. 48 lbs. | 2,270 | 2,423 | 2,504 | 2,554 | 2,633 | 2,718 | 2,795 | 2,873 | 2,952 | 3,033 | 3,404 | 3,674 |

OPTIONS

| | | | | | |
|----------|---|-------|------------|--|-------|
| -PFM02 | Premium Metal Leg Finish | \$101 | -TAR02-() | Rotating Tablet, Right (as seated) | \$593 |
| -MB02 | Moisture Barrier | \$89 | -TAL02-() | Rotating Tablet, Left (as seated) | \$593 |
| -NS04 | Non-Skid Glides | \$26 | -STR01-() | Stationary Table-ette, Right (as seated) | \$593 |
| -GC07 | Ganging Connector | \$66 | -STL01-() | Stationary Table-ette, Left (as seated) | \$593 |
| -MT2-() | Mini-Tap Power Unit (2 power) | \$414 | -PFW01 | Premium Wood Finish (tablet/table-ette) | \$12 |
| -MT3-() | Mini-Tap Power Unit (1 power, 1 USB-A, 1 USB-C) | \$380 | | | |

Note: Please specify (-B) for black and (-W) for white on Mini-Tap Power Units. Please specify (-W) for wood and (-L) for laminate on Rotating Tablet and Stationary Table-ette.

All shipments for this series will be blanket-wrapped as standard. For customers located in Territory 1 who require cartoning, a 5% upcharge will be added to each product. Please contact client services for additional information.

PLAYGROUND MODULAR - CONFIGURATION & ORDERING EXAMPLES

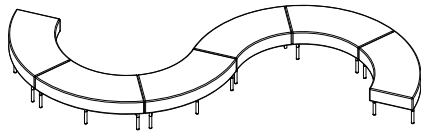

| <u>Qty.</u> | <u>Model #</u> | <u>Description</u> | <u>COM List</u> |
|-------------|----------------|--|-----------------|
| 6 | 7260 | 60-Degree Inside Wedge Bench (\$2,270 List each) | \$13,620 |

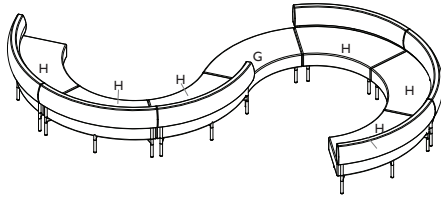

| <u>Qty.</u> | <u>Model #</u> | <u>Description</u> | <u>COM List</u> | <u>Key</u> |
|-------------|----------------|---|--------------------|------------|
| 6 | 7260-BR | Bench with Backrest, 60-Degree Inside Wedge (\$3,419 List each) | \$20,514 | H |
| 1 | 7260 | 60-Degree Inside Wedge Bench | \$2,270 | G |
| | | | \$22,784 | |

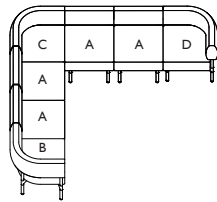

| <u>Qty.</u> | <u>Model #</u> | <u>Description</u> | <u>COM List</u> | <u>Key</u> |
|-------------|----------------|---|--------------------|------------|
| 4 | 7224-BR | Bench with Backrest, 24" Straight (\$2,036 List each) | \$8,144 | A |
| 1 | 7223-BR-L | Bench with Backrest, Left End Corner Unit | \$2,286 | B |
| 1 | 7223-BR-C | Bench with Backrest, Corner Unit | \$2,286 | C |
| 1 | 7223-BR-R | Bench with Backrest, Right End Corner Unit | \$2,286 | D |
| | | | \$15,002 | |

PLAYGROUND MODULAR | Designed by Chris Panichella

UPHOLSTERY COMBINATIONS:

- For upholstery combinations, refer to the pricing below.
- When combining two COM/COV/COL fabrics, or fabrics with the same grade, add \$120 List per unit.
- When combining three or more COM/COV/COL fabrics, or fabrics with the same grade, add \$150 List per unit.
- When combining different grades of fabric, price will be based on the highest grade specified.
- Two-tone upholstery examples and yardage requirements for the most common combinations are listed below. Additional combinations available; please contact client services for yardage requirements and pricing.
- Note: Yardage amounts are based on fabric which is plain (i.e. non-directional) and a full 54" wide.
- Appropriate upholstery code must be included.

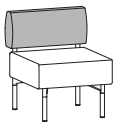

Code PL1
Model COM Requirement
 7224-BR Backrest Only = 1 yd.
 Balance of Bench = 1.75 yds.

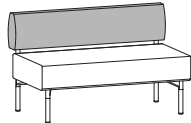

Code PL2
Model COM Requirement
 7248-BR Backrest Only = 2 yds.
 Balance of Bench = 2 yds.

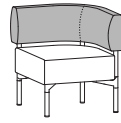

Code PL3
Model COM Requirement
 7223-BR-C Backrest Only = 1.25 yds.
 7223-BR-L Balance of Bench = 1.25 yds.
 7223-BR-R

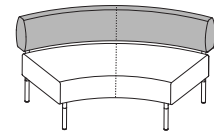

Code PL5
Model COM Requirement
 7260-BR Backrest Only = 2 yds.
 Balance of Bench = 2.25 yds.

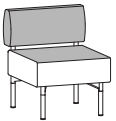

Code PL10
Model COM Requirement
 7224-BR Backrest & Top of Seat = 2.5 yds.
 Balance of Bench = .75 yds.

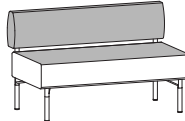

Code PL11
Model COM Requirement
 7248-BR Backrest & Top of Seat = 3.5 yds.
 Balance of Bench = .75 yds.

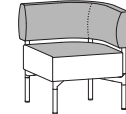

Code PL12
Model COM Requirement
 7223-BR-C Backrest & Top of Seat = 1.75 yds.
 7223-BR-L Balance of Bench = .75 yds.
 7223-BR-R

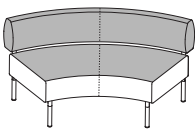

Code PL14
Model COM Requirement
 7260-BR Backrest & Top of Seat = 3 yds.
 Balance of Bench = 1.75 yds.

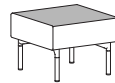

Code PL19
Model COM Requirement
 7224 Top of Seat = 1.5 yds.
 Balance of Bench = .75 yds.

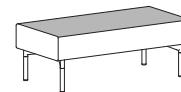

Code PL20
Model COM Requirement
 7248 Top of Seat = 1.5 yds.
 Balance of Bench = .75 yds.

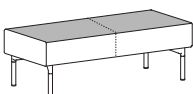

Code PL21
Model COM Requirement
 7256 Top of Seat = 2 yds.
 Balance of Bench = .75 yds.

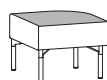

Code PL22
Model COM Requirement
 7223-C Top of Seat = 1.5 yds.
 7223-L Balance of Bench = .75 yds.
 7223-R

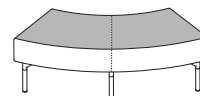

Code PL23
Model COM Requirement
 7260 Top of Seat = 1.75 yds.
 7261 Balance of Bench = 1.75 yds.

All shipments for this series will be blanket-wrapped as standard. For customers located in Territory 1 who require cartoning, a 5% upcharge will be added to each product. Please contact client services for additional information.

PLUMEYA CONFERENCE/EXECUTIVE | Designed by CLAUDIO BELLINI Studio



SPECIFICATIONS:

- Mid- and high back models.
- Aluminum die-cast base offered in Polished Aluminum as standard. Premium finishes also available; please refer to listing below.
- For custom metal finish colors, please contact client services for pricing.
- Swivel-tilt with tilt-lock mechanism.
- 300 lb. weight capacity.
- All dimensions are nominal.
- Refer to terms and conditions for general information regarding fabrics, finishes, warranty, freight, complete condition of sales and more.

PREMIUM METAL BASE FINISH COLORS:

- | | |
|------------------------|-----------------|
| ■ 0405 Charcoal Grey | ■ 0905 Mint |
| ■ 0535 Metallic Silver | ■ 1005 Mercury |
| ■ 0630 Satin Black | ■ 1105 Canary |
| ■ 0605 Matte Black | ■ 1205 Stone |
| ■ 0705 Matte Cotton | ■ 1305 Sage |
| ■ 0788 Glossy Cotton | ■ 1405 Ice Blue |
| ■ 0805 Oasis | ■ 1505 Clay |



All shipments for this series will be blanket-wrapped as standard. For customers located in Territory 1 who require cartoning, a 5% upcharge will be added to each product. Please contact client services for additional information.

PLUMEYA CONFERENCE/EXECUTIVE | Designed by CLAUDIO BELLINI Studio

Swivel-Tilt with Tilt Lock Mechanism

ORDERING REQUIREMENTS:

- Model number
- Base finish
- Upholstery selection
- Options, as applicable

| MODEL | PRODUCT SPECIFICATIONS | FABRIC GRADES | | | | | | | | LEATHER | | | |
|--|--|---------------|-------|-------|-------|-------|-------|----------|-------|---------|-------|-------|-------|
| | | COM | A | 1 | 2 | 3 | 4 | COL 5 | 6 | 7 | 8 | L1 | L2 |
| 9301-SC  | Mid-Back Conference/Executive Chair 26.5" W x 26.5" D x 34" - 36.5" H Seat: 19" W x 19" D Seat Ht: 18" - 20.5" COM: 2.5 yds. COL: 50 sq. ft. 38 lbs. | 1,776 | 1,946 | 2,036 | 2,091 | 2,179 | 2,274 | 2,359 | 2,446 | 2,534 | 2,624 | 3,036 | 3,336 |
| 9311-SC  | High Back Conference/Executive Chair 26.5" W x 26.75" D x 37" - 39.5" H Seat: 19" W x 19" D Seat Ht: 10" - 20.5" COM: 3 yds. COL: 60 sq. ft. 41 lbs. | 1,881 | 2,085 | 2,193 | 2,259 | 2,364 | 2,478 | 2,580 | 2,685 | 2,790 | 2,898 | 3,393 | 3,753 |

OPTIONS

| | | |
|---------|---------------------------------|-------|
| -PFM02 | Premium Metal Base Finish | \$101 |
| -STC02 | Soft Tread Casters | \$33 |
| -STLC02 | Soft Tread Self-Locking Casters | \$63 |
| -GDO4 | Glides | \$30 |

PLUMEYA CONFERENCE/EXECUTIVE | Designed by CLAUDIO BELLINI Studio

UPHOLSTERY COMBINATIONS:

- For upholstery combinations, refer to the pricing below.
- When combining two COM/COV/COL fabrics, or fabrics with the same grade, add \$120 List per unit.
- When combining three or more COM/COV/COL fabrics, or fabrics with the same grade, add \$150 List per unit.
- When combining different grades of fabric, price will be based on the highest grade specified.
- Two-tone upholstery examples and yardage requirements for the most common combinations are listed below. Additional combinations available; please contact client services for yardage requirements and pricing.
- Note: Yardage amounts are based on fabric which is plain (i.e. non-directional) and a full 54" wide.
- Appropriate upholstery code must be included.



Code **PC1**
Model COM Requirement
9301-SC Seat Cushion = 1 yd.
Balance of Chair = 2 yds.



Code **PC2**
Model COM Requirement
9311-SC Seat Cushion = 1 yd.
Balance of Chair = 2.5 yds.



Code **PC3**
Model COM Requirement
9301-SC Arm Panels = 1.25 yds.
Balance of Chair = 1.75 yds.



Code **PC4**
Model COM Requirement
9311-SC Arm Panels = 1.25 yds.
Balance of Chair = 2 yds.

All shipments for this series will be blanket-wrapped as standard. For customers located in Territory 1 who require cartoning, a 5% upcharge will be added to each product. Please contact client services for additional information.

PLUMEYA GUEST | Designed by CLAUDIO BELLINI Studio



SPECIFICATIONS:

- Mid- and high back models.
- Four base options available: 4-leg metal, metal swivel, 4-leg wood and wood swivel.
- Swivel base models feature self-return.
- Metal bases offered in standard and premium finishes. Please refer to listing below.
- For custom metal finish colors, please contact client services for pricing.
- Wood bases offered in all standard and custom finishes on Ash.
- For custom wood finishes, please contact client services and add one-time upcharge of \$531 List per color per order.
- For Alabaster and Super Matte Sable Ash, premium wood finish upcharge applies. Refer to options section for pricing.
- 300 lb. weight capacity.
- All dimensions are nominal.
- Refer to terms and conditions for general information regarding fabrics, finishes, warranty, freight, complete condition of sales and more.

STANDARD METAL BASE FINISH COLORS:

- 0405 Charcoal Grey
- 0535 Metallic Silver
- 0299 Polished Aluminum (swivel base only)
- 0630 Satin Black

PREMIUM METAL BASE FINISH COLORS:





- 0605 Matte Black
- 0705 Matte Cotton
- 0788 Glossy Cotton
- 0805 Oasis
- 0905 Mint
- 1005 Mercury
- 1105 Canary
- 1205 Stone
- 1305 Sage
- 1405 Ice Blue
- 1505 Clay

All shipments for this series will be blanket-wrapped as standard. For customers located in Territory 1 who require cartoning, a 5% upcharge will be added to each product. Please contact client services for additional information.

PLUMEYA GUEST | Designed by CLAUDIO BELLINI Studio

ORDERING REQUIREMENTS:

- Model number
- Base finish
- Upholstery selection
- Options, as applicable

| MODEL | PRODUCT SPECIFICATIONS | FABRIC GRADES | | | | | | | | LEATHER | | | |
|---|--|---------------|-------|-------|-------|-------|-------|----------|-------|---------|-------|-------|-------|
| | | COM | A | 1 | 2 | 3 | 4 | COL 5 | 6 | 7 | 8 | L1 | L2 |
| 9301-M  | Mid-Back Guest Chair, 4-Leg Metal Base 26.5" W x 26.5" D x 34" H Seat: 19" W x 19" D Seat Ht: 18" COM: 2.5 yds. COL: 50 sq. ft. 30 lbs. | 1,499 | 1,669 | 1,759 | 1,814 | 1,902 | 1,997 | 2,082 | 2,169 | 2,257 | 2,347 | 2,759 | 3,059 |
| 9301-SG  | Mid-Back Guest Chair, Metal Swivel Base 27.5" W x 27.5" D x 34" H Seat: 19" W x 19" D Seat Ht: 18" COM: 2.5 yds. COL: 50 sq. ft. 32 lbs. | 1,695 | 1,865 | 1,955 | 2,010 | 2,098 | 2,193 | 2,278 | 2,365 | 2,453 | 2,543 | 2,955 | 3,255 |
| 9301-W  | Mid-Back Guest Chair, 4-Leg Wood Base 26.5" W x 26.5" D x 34" H Seat: 19" W x 19" D Seat Ht: 18" COM: 2.5 yds. COL: 50 sq. ft. 28 lbs. | 1,670 | 1,840 | 1,930 | 1,985 | 2,073 | 2,168 | 2,253 | 2,340 | 2,428 | 2,518 | 2,930 | 3,230 |
| 9301-SW  | Mid-Back Guest Chair, Wood Swivel Base 26.5" W x 26.5" D x 34" H Seat: 19" W x 19" D Seat Ht: 18" COM: 2.5 yds. COL: 50 sq. ft. 36 lbs. | 1,924 | 2,094 | 2,184 | 2,239 | 2,327 | 2,422 | 2,507 | 2,594 | 2,682 | 2,772 | 3,184 | 3,484 |

OPTIONS





| | | |
|--------|---------------------------|-------|
| -PFM02 | Premium Metal Base Finish | \$101 |
| -PFW02 | Premium Wood Base Finish | \$23 |
| -NSO4 | Non-Skid Glides | \$26 |

All shipments for this series will be blanket-wrapped as standard. For customers located in Territory 1 who require cartoning, a 5% upcharge will be added to each product. Please contact client services for additional information.

PLUMEYA GUEST | Designed by CLAUDIO BELLINI Studio

ORDERING REQUIREMENTS:

- Model number
- Base finish
- Upholstery selection
- Options, as applicable

| MODEL | PRODUCT SPECIFICATIONS | FABRIC GRADES | | | | | | | | LEATHER | | | |
|---|---|---------------|-------|-------|-------|-------|-------|----------|-------|---------|-------|-------|-------|
| | | COM | A | 1 | 2 | 3 | 4 | COL 5 | 6 | 7 | 8 | L1 | L2 |
| 9311-M  | High Back Guest Chair, 4-Leg Metal Base 26.5" W x 26.75" D x 37" H Seat: 19" W x 19" D Seat Ht: 18" COM: 3 yds. COL: 60 sq. ft. 33 lbs. | 1,604 | 1,808 | 1,916 | 1,982 | 2,087 | 2,201 | 2,303 | 2,408 | 2,513 | 2,621 | 3,116 | 3,476 |
| 9311-SG  | High Back Guest Chair, Metal Swivel Base 27.5" W x 27.5" D x 37" H Seat: 19" W x 19" D Seat Ht: 18" COM: 3 yds. COL: 60 sq. ft. 35 lbs. | 1,800 | 2,004 | 2,112 | 2,178 | 2,283 | 2,397 | 2,499 | 2,604 | 2,709 | 2,817 | 3,312 | 3,672 |
| 9311-W  | High Back Guest Chair, 4-Leg Wood Base 26.5" W x 26.75" D x 37" H Seat: 19" W x 19" D Seat Ht: 18" COM: 3 yds. COL: 60 sq. ft. 31 lbs. | 1,775 | 1,979 | 2,087 | 2,153 | 2,258 | 2,372 | 2,474 | 2,579 | 2,684 | 2,792 | 3,287 | 3,647 |
| 9311-SW  | High Back Guest Chair, Wood Swivel Base 26.5" W x 26.75" D x 37" H Seat: 19" W x 19" D Seat Ht: 18" COM: 3 yds. COL: 60 sq. ft. 39 lbs. | 2,029 | 2,233 | 2,341 | 2,407 | 2,512 | 2,626 | 2,728 | 2,833 | 2,938 | 3,046 | 3,541 | 3,901 |

OPTIONS

| | | |
|--------|---------------------------|-------|
| -PFM02 | Premium Metal Base Finish | \$101 |
| -PFW02 | Premium Wood Base Finish | \$23 |
| -NSO4 | Non-Skid Glides | \$26 |

PLUMEYA GUEST | Designed by CLAUDIO BELLINI Studio

UPHOLSTERY COMBINATIONS:

- For upholstery combinations, refer to the pricing below.
- When combining two COM/COV/COL fabrics, or fabrics with the same grade, add \$120 List per unit.
- When combining three or more COM/COV/COL fabrics, or fabrics with the same grade, add \$150 List per unit.
- When combining different grades of fabric, price will be based on the highest grade specified.
- Two-tone upholstery examples and yardage requirements for the most common combinations are listed below. Additional combinations available; please contact client Services for yardage requirements and pricing.
- Note: Yardage amounts are based on fabric which is plain (i.e. non-directional) and a full 54" wide.
- Appropriate upholstery code must be included.



Code

Model

All Mid-Back Models

PG1

COM Requirement

Seat Cushion = 1 yd.
Balance of Chair = 2 yds.



Code

Model

All High Back Models

PG2

COM Requirement

Seat Cushion = 1 yd.
Balance of Chair = 2.5 yds.



Code

Model

All Mid-Back Models

PG3

COM Requirement

Arm Panels = 1.25 yds.
Balance of Chair = 1.75 yds.



Code

Model

All High Back Models

PG4

COM Requirement

Arm Panels = 1.25 yds.
Balance of Chair = 2 yds.

All shipments for this series will be blanket-wrapped as standard. For customers located in Territory 1 who require cartoning, a 5% upcharge will be added to each product. Please contact client services for additional information.

PLUMEYA LOUNGE | Designed by CLAUDIO BELLINI Studio



SPECIFICATIONS:

- Mid- and high back models.
- Three base options available: metal swivel, 4-leg wood and wood swivel.
- Swivel base models feature self-return and are available with or without rocker mechanism.
- Metal swivel base offered in polished aluminum as standard. Premium finishes also available; please refer to listing below.
- For custom metal finish colors, please contact client services for pricing.
- Wood bases offered in all standard and custom finishes on Ash.
- For custom wood finishes, please contact client services and add one-time upcharge of \$531 List per color per order.
- For Alabaster and Super Matte Sable Ash, premium wood finish upcharge applies. Refer to options section for pricing.
- 300 lb. weight capacity.
- All dimensions are nominal.
- Refer to terms and conditions for general information regarding fabrics, finishes, warranty, freight, complete condition of sales and more.

PREMIUM METAL BASE FINISH COLORS:





- | | |
|------------------------|-----------------|
| ■ 0405 Charcoal Grey | ■ 0905 Mint |
| ■ 0535 Metallic Silver | ■ 1005 Mercury |
| ■ 0630 Satin Black | ■ 1105 Canary |
| ■ 0605 Matte Black | ■ 1205 Stone |
| ■ 0705 Matte Cotton | ■ 1305 Sage |
| ■ 0788 Glossy Cotton | ■ 1405 Ice Blue |
| ■ 0805 Oasis | ■ 1505 Clay |

All shipments for this series will be blanket-wrapped as standard. For customers located in Territory 1 who require cartoning, a 5% upcharge will be added to each product. Please contact client services for additional information.

PLUMEYA LOUNGE | Designed by CLAUDIO BELLINI Studio

ORDERING REQUIREMENTS:

- Model number
- Base finish
- Upholstery selection
- Options, as applicable

| MODEL | PRODUCT SPECIFICATIONS | FABRIC GRADES | | | | | | | | LEATHER | | | |
|--|---|---------------|-------|-------|-------|-------|-------|----------|-------|---------|-------|-------|-------|
| | | COM | A | 1 | 2 | 3 | 4 | COL 5 | 6 | 7 | 8 | L1 | L2 |
| 9351-W  | Mid-Back Lounge Chair, 4-Leg Wood Base 29" W x 29" D x 31.25" H Seat: 20.5" W x 20.5" D Seat Ht: 17" COM: 3 yds. COL: 60 sq. ft. 34 lbs. | 1,986 | 2,190 | 2,298 | 2,364 | 2,469 | 2,583 | 2,685 | 2,790 | 2,895 | 3,003 | 3,498 | 3,858 |
| 9351-SW  | Mid-Back Lounge Chair, Wood Swivel Base 32.5" W x 32.5" D x 31.25" H Seat: 20.5" W x 20.5" D Seat Ht: 16.25" COM: 3 yds. COL: 60 sq. ft. 42 lbs. | 1,894 | 2,098 | 2,206 | 2,272 | 2,377 | 2,491 | 2,593 | 2,698 | 2,803 | 2,911 | 3,406 | 3,766 |
| 9351-SW-RM01  | Mid-Back Lounge Chair, Wood Swivel Base with Rocker 32.5" W x 32.5" D x 32" H Seat: 20.5" W x 20.5" D Seat Ht: 17" COM: 3 yds. COL: 60 sq. ft. 46 lbs. | 1,988 | 2,192 | 2,300 | 2,366 | 2,471 | 2,585 | 2,687 | 2,792 | 2,897 | 3,005 | 3,500 | 3,860 |
| 9351-SG  | Mid-Back Lounge Chair, Metal Swivel Base 33.5" W x 33.5" D x 31.25" H Seat: 20.5" W x 20.5" D Seat Ht: 16.25" COM: 3 yds. COL: 60 sq. ft. 41 lbs. | 1,788 | 1,992 | 2,100 | 2,166 | 2,271 | 2,385 | 2,487 | 2,592 | 2,697 | 2,805 | 3,300 | 3,660 |
| 9351-SG-RM01  | Mid-Back Lounge Chair, Metal Swivel Base with Rocker 33.5" W x 33.5" D x 32" H Seat: 20.5" W x 20.5" D Seat Ht: 17" COM: 3 yds. COL: 60 sq. ft. 45 lbs. | 1,882 | 2,086 | 2,194 | 2,260 | 2,365 | 2,479 | 2,581 | 2,686 | 2,791 | 2,899 | 3,394 | 3,754 |

OPTIONS





| | | |
|--------|---------------------------|-------|
| -PFM02 | Premium Metal Base Finish | \$101 |
| -PFW02 | Premium Wood Base Finish | \$23 |
| -NSO4 | Non-Skid Glides | \$26 |

All shipments for this series will be blanket-wrapped as standard. For customers located in Territory 1 who require cartoning, a 5% upcharge will be added to each product. Please contact client services for additional information.

PLUMEYA LOUNGE | Designed by CLAUDIO BELLINI Studio

ORDERING REQUIREMENTS:

- Model number
- Base finish
- Upholstery selection
- Options, as applicable

| MODEL | PRODUCT SPECIFICATIONS | FABRIC GRADES | | | | | | | | | | LEATHER | |
|--|--|---------------|-------|-------|-------|-------|-------|----------|-------|-------|-------|---------|-------|
| | | COM | A | 1 | 2 | 3 | 4 | COL 5 | 6 | 7 | 8 | L1 | L2 |
| 9361-W  | High Back Lounge Chair, 4-Leg Wood Base 29" W x 29.25" D x 34.25" H Seat: 20.5" W x 20.5" D Seat Ht: 17" COM: 3.5 yds. COL: 70 sq. ft. 37 lbs. | 2,107 | 2,345 | 2,471 | 2,548 | 2,671 | 2,804 | 2,923 | 3,045 | 3,168 | 3,294 | 3,871 | 4,291 |
| 9361-SW  | High Back Lounge Chair, Wood Swivel Base 32.5" W x 32.5" D x 34.25" H Seat: 20.5" W x 20.5" D Seat Ht: 16.25" COM: 3.5 yds. COL: 70 sq. ft. 45 lbs. | 2,014 | 2,252 | 2,378 | 2,455 | 2,578 | 2,711 | 2,830 | 2,952 | 3,075 | 3,201 | 3,778 | 4,198 |
| 9361-SW-RM01  | High Back Lounge Chair, Wood Swivel Base with Rocker 32.5" W x 32.5" D x 35" H Seat: 20.5" W x 20.5" D Seat Ht: 17" COM: 3.5 yds. COL: 70 sq. ft. 49 lbs. | 2,108 | 2,346 | 2,472 | 2,549 | 2,672 | 2,805 | 2,924 | 3,046 | 3,169 | 3,295 | 3,872 | 4,292 |
| 9361-SG  | High Back Lounge Chair, Metal Swivel Base 33.5" W x 33.5" D x 34.25" H Seat: 20.5" W x 20.5" D Seat Ht: 16.25" COM: 3.5 yds. COL: 70 sq. ft. 44 lbs. | 1,908 | 2,146 | 2,272 | 2,349 | 2,472 | 2,605 | 2,724 | 2,846 | 2,969 | 3,095 | 3,672 | 4,092 |
| 9361-SG-RM01  | High Back Lounge Chair, Metal Swivel Base with Rocker 33.5" W x 33.5" D x 35" H Seat: 20.5" W x 20.5" D Seat Ht: 17" COM: 3.5 yds. COL: 70 sq. ft. 48 lbs. | 2,002 | 2,240 | 2,366 | 2,443 | 2,566 | 2,699 | 2,818 | 2,940 | 3,063 | 3,189 | 3,766 | 4,186 |

OPTIONS

| | | |
|--------|---------------------------|-------|
| -PFM02 | Premium Metal Base Finish | \$101 |
| -PFW02 | Premium Wood Base Finish | \$23 |
| -NSO4 | Non-Skid Glides | \$26 |

PLUMEYA LOUNGE | Designed by CLAUDIO BELLINI Studio

UPHOLSTERY COMBINATIONS:

- For upholstery combinations, refer to the pricing below.
- When combining two COM/COV/COL fabrics, or fabrics with the same grade, add \$120 List per unit.
- When combining three or more COM/COV/COL fabrics, or fabrics with the same grade, add \$150 List per unit.
- When combining different grades of fabric, price will be based on the highest grade specified.
- Two-tone upholstery examples and yardage requirements for the most common combinations are listed below. Additional combinations available; please contact client services for yardage requirements and pricing.
- Note: Yardage amounts are based on fabric which is plain (i.e. non-directional) and a full 54" wide.
- Appropriate upholstery code must be included.



Code

Model

All Mid-Back Models

PU1

COM Requirement

Seat Cushion = 1.25 yds.
Balance of Chair = 2.25 yds.



Code

Model

All High Back Models

PU2

COM Requirement

Seat Cushion = 1.25 yds.
Balance of Chair = 2.75 yds.



Code

Model

All Mid-Back Models

PU3

COM Requirement

Arm Panels = 1.5 yds.
Balance of Chair = 2 yds.



Code

Model

All High Back Models

PU4

COM Requirement

Arm Panels = 1.5 yds.
Balance of Chair = 2.5 yds.

All shipments for this series will be blanket-wrapped as standard. For customers located in Territory 1 who require cartoning, a 5% upcharge will be added to each product. Please contact client services for additional information.

POPOVER POUFS | Designed by Chris & Jon Panichella



SPECIFICATIONS:

- Square poufs available in two sizes: 20" and 24".
- Leather pull/strap offered in four standard colors. Please refer to listing below.
- Pull/strap also available in COL (Customer's Own Leather).
- Each unit comes standard with glides.
- Optional felt glides for hard surface flooring.
- 300 lb. weight capacity.
- All dimensions are nominal.
- Refer to terms and conditions for general information regarding fabrics, finishes, warranty, freight, complete condition of sales and more.

STANDARD LEATHER PULL/STRAP COLORS:

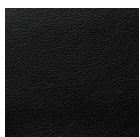

Black

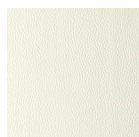

Bright White

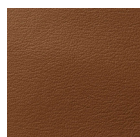

Saddle

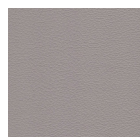



Fog

All shipments for this series will be blanket-wrapped as standard. For customers located in Territory 1 who require cartoning, a 5% upcharge will be added to each product. Please contact client services for additional information.

POPOVER POUFS | Designed by Chris & Jon Panichella

ORDERING REQUIREMENTS:

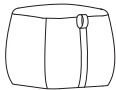
- Model number
- Pull/strap color
- Upholstery selection
- Options, as applicable

| MODEL | PRODUCT SPECIFICATIONS | FABRIC GRADES | | | | | | | | LEATHER | | | |
|-------|---|---------------|-------|-------|-------|-------|-------|----------|-------|---------|-------|-------|-------|
| | | COM | A | 1 | 2 | 3 | 4 | COL 5 | 6 | 7 | 8 | L1 | L2 |
| 3820 |  <p>20" Square Pouf 20" W x 20" D x 17.5" H COM: 2 yds. COL: 40 sq. ft. 22 lbs.</p> | 1,043 | 1,179 | 1,251 | 1,295 | 1,365 | 1,441 | 1,509 | 1,579 | 1,649 | 1,721 | 2,051 | 2,291 |
| 3824 |  <p>24" Square Pouf 24" W x 24" D x 17.5" H COM: 2 yds. COL: 40 sq. ft. 28 lbs.</p> | 1,212 | 1,348 | 1,420 | 1,464 | 1,534 | 1,610 | 1,678 | 1,748 | 1,818 | 1,890 | 2,220 | 2,460 |

OPTIONS

- P02 COL Pull/Strap \$152
(requires 3" x 30" per unit)
- FG04 Felt Glides \$26

 = Available on quick-ship program.

All shipments for this series will be blanket-wrapped as standard. For customers located in Territory 1 who require cartoning, a 5% upcharge will be added to each product. Please contact client services for additional information.

POPOVER POUFS | Designed by Chris & Jon Panichella

UPHOLSTERY COMBINATIONS:

- For upholstery combinations, refer to the pricing below.
- When combining two COM/COV/COL fabrics, or fabrics with the same grade, add \$120 List per unit.
- When combining three or more COM/COV/COL fabrics, or fabrics with the same grade, add \$150 List per unit.
- When combining different grades of fabric, price will be based on the highest grade specified.
- Two-tone upholstery examples and yardage requirements for the most common combinations are listed below. Additional combinations available; please contact client services for yardage requirements and pricing.
- Note: Yardage amounts are based on fabric which is plain (i.e. non-directional) and a full 54" wide.
- Appropriate upholstery code must be included.

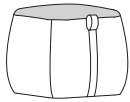

Code PV1

| <u>Model</u> | <u>COM Requirement</u> |
|--------------|--|
| All Models | Top of Seat = .75 yd. Side Panels = 1.25 yds. |

All shipments for this series will be blanket-wrapped as standard. For customers located in Territory 1 who require cartoning, a 5% upcharge will be added to each product. Please contact client services for additional information.

RECESS® GUEST



SPECIFICATIONS:

- Arm and armless options.
- Arm model features black polypropylene arm cap.
- Frame available in standard and premium finishes. See below for options.
- For custom metal finish colors, please contact client services for pricing.
- Stacks 6-high from floor.
- If cartoning is required, chairs are packaged in units of three (3). A \$20 List carton break charge will be applied for orders with only one or two chairs.
- 300 lb. weight capacity.
- All dimensions are nominal.
- Refer to terms and conditions for general information regarding fabrics, finishes, warranty, freight, complete condition of sales and more.

STANDARD METAL FRAME FINISH COLORS:

- 0405 Charcoal Grey
- 0535 Metallic Silver

PREMIUM METAL FRAME FINISH COLORS:



- 0605 Matte Black
- 0705 Matte Cotton
- 0788 Glossy Cotton
- 0805 Oasis
- 0905 Mint
- 1005 Mercury
- 1105 Canary
- 1205 Stone
- 1305 Sage
- 1405 Ice Blue
- 1505 Clay

All shipments for this series will be blanket-wrapped as standard. For customers located in Territory 1 who require cartoning, a 5% upcharge will be added to each product. Please contact client services for additional information.

RECESS® GUEST

ORDERING REQUIREMENTS:

- Model number
- Frame finish
- Upholstery selection
- Options, as applicable

| MODEL | PRODUCT SPECIFICATIONS | FABRIC GRADES | | | | | | | | LEATHER | | | |
|---|---|---------------|-----|-----|-----|-----|-----|----------|-------|---------|-------|-------|-------|
| | | COM | A | 1 | 2 | 3 | 4 | COL 5 | 6 | 7 | 8 | L1 | L2 |
| 2210  | Fully Upholstered, Arms 22" W x 25" D x 33" H Seat: 19.5" W x 20" D Seat Ht: 18" Arm Ht: 25.75" COM: 1.5 yds. COL: 30 sq. ft. 25 lbs. | 669 | 771 | 825 | 858 | 911 | 968 | 1,019 | 1,071 | 1,124 | 1,178 | 1,425 | 1,605 |
| 2230  | Fully Upholstered, Armless 21" W x 25" D x 33" H Seat: 19.5" W x 20" D Seat Ht: 18" COM: 1.5 yds. COL: 30 sq. ft. 23 lbs. | 658 | 760 | 814 | 847 | 900 | 957 | 1,008 | 1,060 | 1,113 | 1,167 | 1,414 | 1,594 |

OPTIONS

| | | |
|--------|----------------------------|-------|
| -PFM02 | Premium Metal Frame Finish | \$101 |
| -EF01 | 1" Additional Seat Foam | \$44 |
| -GC08 | Ganging Bracket | \$42 |
| -VCT04 | VCT Tile Glides | \$28 |

All shipments for this series will be cartoned as standard. If blanket-wrapped shipping is required, please contact client services for additional information.

ROMP OCCASIONAL TABLES | Designed by Gower + Woolf



SPECIFICATIONS:

- Metal frame with inset table-top.
- Frame is comprised of 14-gauge steel tray and ½" solid metal rod legs.
- Four top surface options: wood veneer, laminate, Fenix and solid surface.
- Wood veneer available in all standard and custom finishes on Ash.
- For custom wood finishes, please contact client services and add one-time upcharge of \$531 List per color per order.
- For Alabaster and Super Matte Sable Ash, premium wood finish upcharge applies. Refer to options section for pricing.
- For custom laminate options, add \$649 List per color per order. Pre-approval required, please contact client services.
- Fenix offered in five standard colorways.
- For non-standard Fenix colors, please contact client services for pricing.
- Solid surface available in white only.
- Metal frame offered in standard and premium metal finishes (chrome not available). Please refer to listing below.
- Legs ship separately (assembly required).
- All dimensions are nominal.
- Refer to terms and conditions for general information regarding finishes, warranty, freight, complete condition of sales and more.

FENIX COLORS:

- Bianco Kos
- Nero Ingo
- Grigio Efeso
- Grigio Londra
- Grigio Bromo

STANDARD METAL FRAME FINISH COLORS:

- 0405 Charcoal Grey
- 0535 Metallic Silver
- 0630 Satin Black

PREMIUM METAL FRAME FINISH COLORS:



- 0605 Matte Black
- 0705 Matte Cotton
- 0788 Glossy Cotton
- 0805 Oasis
- 0905 Mint
- 1005 Mercury
- 1105 Canary
- 1205 Stone
- 1305 Sage
- 1405 Ice Blue
- 1505 Clay

All shipments for this series will be cartoned as standard. If blanket-wrapped shipping is required, please contact client services for additional information.

ROMP OCCASIONAL TABLES | Designed by Gower + Woolf

ORDERING REQUIREMENTS:

- Model number
- Top surface material
- Top finish, as applicable
- Frame finish
- Options, as applicable

| MODEL | DIMENSIONS | veneER TOP (-V) | LAMINATE TOP (-L) | FENIX TOP (-FE) | SOLID SURFACE TOP (-SF) | WEIGHT |
|--|------------------|-----------------|-------------------|-----------------|-------------------------|---------|
|  16" Height 2000-2116-() 2000-3016-() 2000-3616-() | 21" Dia. x 16" H | 1,487 | 1,351 | 1,492 | 1,606 | 19 lbs. |
| | 30" Dia. x 16" H | 1,970 | 1,789 | 2,077 | 2,483 | 30 lbs. |
| | 36" Dia. x 16" H | 2,432 | 2,139 | 2,554 | 3,138 | 35 lbs. |
|  18" Height 2000-2118-() 2000-3018-() 2000-3618-() | 21" Dia. x 18" H | 1,503 | 1,367 | 1,508 | 1,622 | 22 lbs. |
| | 30" Dia. x 18" H | 1,986 | 1,804 | 2,092 | 2,498 | 33 lbs. |
| | 36" Dia. x 18" H | 2,447 | 2,155 | 2,570 | 3,154 | 38 lbs. |

OPTIONS

- PFM02 Premium Metal Frame Finish \$101
- PFW02 Premium Wood Top Finish \$23

 = Available on quick-ship program (all tops with standard base finishes only).

All shipments for this series will be blanket-wrapped as standard. For customers located in Territory 1 who require cartoning, a 5% upcharge will be added to each product. Please contact client services for additional information.

SIGNAL® GUEST | Licensed from Wiesner Hager - Austria



SPECIFICATIONS:

- 1.25" wide x .75" thick rectangular steel frame.
- Black leather soft-touch arm caps.
- Frame available in standard and premium finishes. Please refer to listing below.
- Horizontal stitching detail also available.
- Optional felt glides for hard surface flooring.
- 350 lb. weight capacity.
- All dimensions are nominal.
- Refer to terms and conditions for general information regarding fabrics, finishes, warranty, freight, complete condition of sales and more.

STANDARD METAL FRAME FINISH COLORS:

- 0405 Charcoal Grey
- 0535 Metallic Silver
- 0199 Chrome
- 0630 Satin Black

PREMIUM METAL FRAME FINISH COLORS:

- 0605 Matte Black
- 0705 Matte Cotton
- 0788 Glossy Cotton
- 0805 Oasis
- 0905 Mint
- 1005 Mercury
- 1105 Canary
- 1205 Stone
- 1305 Sage
- 1405 Ice Blue
- 1505 Clay

All shipments for this series will be blanket-wrapped as standard. For customers located in Territory 1 who require cartoning, a 5% upcharge will be added to each product. Please contact client services for additional information.

SIGNAL® GUEST | Licensed from Wiesner Hager - Austria

ORDERING REQUIREMENTS:

- Model number
- Frame finish
- Upholstery selection
- Options, as applicable

| MODEL | PRODUCT SPECIFICATIONS | FABRIC GRADES | | | | | | | | LEATHER | | | |
|--|--|---------------|-------|-------|-------|-------|-------|----------|-------|---------|-------|-------|-------|
| | | COM | A | 1 | 2 | 3 | 4 | COL 5 | 6 | 7 | 8 | L1 | L2 |
| 3520  | Guest Chair, Arms Cantilever Frame 22" W x 23" D x 35" H Seat: 19.5" W x 18.75" D Seat Ht: 18" Arm Ht: 26" COM: 2 yds. COL: 40 sq. ft. 28 lbs. | 1,582 | 1,718 | 1,790 | 1,834 | 1,904 | 1,980 | 2,048 | 2,118 | 2,188 | 2,260 | 2,590 | 2,830 |

OPTIONS

- PFM02 Premium Metal Frame Finish \$101
- FG04 Felt Glides \$26

All shipments for this series will be blanket-wrapped as standard. For customers located in Territory 1 who require cartoning, a 5% upcharge will be added to each product. Please contact client services for additional information.

SKYLINE MEETING TABLES



SPECIFICATIONS:

- Round and square top shapes available in laminate and solid surface.
- 29" and 42" table heights. Custom heights between 29" and 42" available. Please specify and add \$165 List per unit. Price is based on the higher standard table height (e.g. 32" custom height, price is based on the 42" standard height plus \$165).
- Laminate available in all standard colors.
- For custom laminate options, add \$649 List per color per order. Pre-approval required, please contact client services.
- For standard wood grain laminate or solid black laminate tops, edge will match unless specified otherwise.
- For all other solid laminates, edge will be exposed plywood substrate with clear coat finish.
- Please note that for edge matching on custom laminates (wood grain or otherwise), a \$531 List upcharge will apply.
- Solid surface available in white only.
- Solid surface tops feature exposed plywood substrate edge with clear coat finish.
- Laminate tops are 3/4" thick and solid surface tops are 1" thick.
- Metal column and base plate available in standard and premium finishes. Please refer to listing below.
- For custom metal finish colors, please contact client services for pricing.
- All dimensions are nominal.
- Refer to terms and conditions for general information regarding finishes, warranty, freight, complete condition of sales and more.

EDGE DETAIL:

Laminate* Top

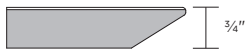

Solid Surface Top

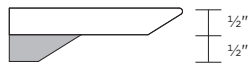

*Please note that laminate thickness is nominal and may vary.

SQUARE TOP SHAPE:

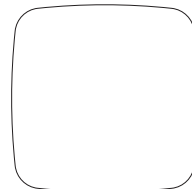

STANDARD METAL BASE FINISH COLORS:

- 0405 Charcoal Grey
- 0535 Metallic Silver
- 0199 Chrome
- 0630 Satin Black

PREMIUM METAL BASE FINISH COLORS:



- 0605 Matte Black
- 0705 Matte Cotton
- 0788 Glossy Cotton
- 0805 Oasis
- 0905 Mint
- 1005 Mercury
- 1105 Canary
- 1205 Stone
- 1305 Sage
- 1405 Ice Blue
- 1505 Clay

All shipments for this series will be blanket-wrapped as standard. For customers located in Territory 1 who require cartoning, a 5% upcharge will be added to each product. Please contact client services for additional information.

SKYLINE MEETING TABLES

ORDERING REQUIREMENTS:

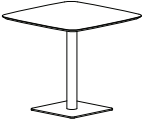
- Model number
- Top surface material
- Top finish, as applicable
- Column/base plate finish
- Options, as applicable

| MODEL | LAMINATE TOP (-L) | SOLID SURFACE TOP (-SF) | COLUMN DIAMETER | BASE PLATE DIMENSIONS | WEIGHT |
|--|-------------------|-------------------------|-----------------|-----------------------|---------|
|  <p>Square Top, 29" Height</p> <p>7100-323229-()</p> <p>7100-363629-()</p> <p>7100-424229-()</p> <p>7100-484829-()</p> | 2,111 | 2,901 | 3" | 18" Square | 68 lbs. |
| | 2,370 | 3,369 | 3" | 22" Square | 76 lbs. |
| | 2,682 | 4,042 | 3" | 22" Square | 85 lbs. |
| | 3,137 | 4,913 | 4" | 22" Square | 91 lbs. |
|  <p>Square Top, 42" Height</p> <p>7100-323242-()</p> <p>7100-363642-()</p> | 2,188 | 2,978 | 3" | 18" Square | 74 lbs. |
| | 2,449 | 3,448 | 3" | 22" Square | 82 lbs. |

OPTIONS

-PFM02 Premium Metal Base Finish \$101

All shipments for this series will be blanket-wrapped as standard. For customers located in Territory 1 who require cartoning, a 5% upcharge will be added to each product. Please contact client services for additional information.

SKYLINE MEETING TABLES

ORDERING REQUIREMENTS:

- Model number
- Top surface material
- Top finish, as applicable
- Column/base plate finish
- Options, as applicable

| MODEL | LAMINATE TOP (-L) | SOLID SURFACE TOP (-SF) | COLUMN DIAMETER | BASE PLATE DIMENSIONS | WEIGHT |
|---|-------------------|-------------------------|-----------------|-----------------------|---------|
|  <p>Round Top, 29" Height</p> <p>7101-2929-()</p> <p>7101-3629-()</p> <p>7101-4229-()</p> <p>7101-4829-()</p> | 2,154 | 2,848 | 3" | 18" Square | 68 lbs. |
| | 2,589 | 3,588 | 3" | 22" Square | 76 lbs. |
| | 2,670 | 4,030 | 3" | 22" Square | 85 lbs. |
| | 2,753 | 4,529 | 4" | 22" Square | 91 lbs. |
|  <p>Round Top, 42" Height</p> <p>7101-2942-()</p> <p>7101-3642-()</p> | 2,232 | 2,926 | 3" | 18" Square | 74 lbs. |
| | 2,666 | 3,665 | 3" | 22" Square | 82 lbs. |

OPTIONS

-PFM02 Premium Metal Base Finish \$101

All shipments for this series will be blanket-wrapped as standard. For customers located in Territory 1 who require cartoning, a 5% upcharge will be added to each product. Please contact client services for additional information.

SKYLINE OCCASIONAL TABLES



SPECIFICATIONS:

- Round and square top shapes available in laminate and solid surface.
- 16" and 18" table heights.
- Laminate available in all standard colors.
- For custom laminate options, add \$649 List per color per order. Pre-approval required, please contact client services.
- For standard wood grain laminate or solid black laminate tops, edge will match unless specified otherwise.
- For all other solid laminates, edge will be exposed plywood substrate with clear coat finish.
- Please note that for edge matching on custom laminates (wood grain or otherwise), a \$531 List upcharge will apply.
- Solid surface available in white only.
- Solid surface tops feature exposed plywood substrate edge with clear coat finish.
- Laminate tops are 3/4" thick and solid surface tops are 1" thick.
- Metal column and base plate available in standard and premium finishes. Please refer to listing below.
- For custom metal finish colors, please contact client services for pricing.
- All dimensions are nominal.
- Refer to terms and conditions for general information regarding finishes, warranty, freight, complete condition of sales and more.

EDGE DETAIL:

Laminate* Top



Solid Surface Top

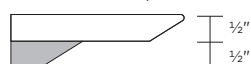

*Please note that laminate thickness is nominal and may vary.

SQUARE TOP SHAPE:

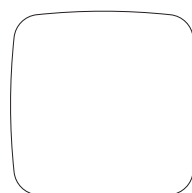

STANDARD METAL BASE FINISH COLORS:

- 0405 Charcoal Grey
- 0535 Metallic Silver
- 0199 Chrome
- 0630 Satin Black

PREMIUM METAL BASE FINISH COLORS:

- 0605 Matte Black
- 0705 Matte Cotton
- 0788 Glossy Cotton
- 0805 Oasis
- 0905 Mint
- 1005 Mercury
- 1105 Canary
- 1205 Stone
- 1305 Sage
- 1405 Ice Blue
- 1505 Clay

All shipments for this series will be blanket-wrapped as standard. For customers located in Territory 1 who require cartoning, a 5% upcharge will be added to each product. Please contact client services for additional information.

SKYLINE OCCASIONAL TABLES

ORDERING REQUIREMENTS:

- Model number
- Top surface material
- Top finish, as applicable
- Column/base plate finish
- Options, as applicable

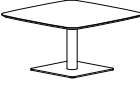
| MODEL | LAMINATE TOP (-L) | SOLID SURFACE TOP (-SF) | COLUMN DIAMETER | BASE PLATE DIMENSIONS | WEIGHT | |
|---|-------------------|-------------------------|-----------------|-----------------------|------------|---------|
|  <p>Square Top, 16" Height</p> | 7100-181816-() | 1,166 | 1,353 | 3" | 14" Square | 19 lbs. |
| | 7100-222216-() | 1,397 | 1,729 | 3" | 14" Square | 30 lbs. |
| | 7100-323216-() | 1,925 | 2,715 | 3" | 18" Square | 52 lbs. |
| | 7100-363616-() | 2,184 | 3,183 | 3" | 22" Square | 58 lbs. |
| | 7100-424216-() | 2,497 | 3,857 | 3" | 22" Square | 66 lbs. |
| | 7100-484816-() | 2,951 | 4,727 | 3" | 22" Square | 72 lbs. |
|  <p>Square Top, 18" Height</p> | 7100-484818-() | 3,007 | 4,783 | 4" | 22" Square | 75 lbs. |
|  <p>Round Top, 16" Height</p> | 7101-1916-() | 1,244 | 1,453 | 3" | 14" Square | 19 lbs. |
| | 7101-2116-() | 1,317 | 1,572 | 3" | 14" Square | 30 lbs. |
| | 7101-2916-() | 1,969 | 2,663 | 3" | 18" Square | 52 lbs. |
| | 7101-3616-() | 2,404 | 3,403 | 3" | 22" Square | 58 lbs. |
| | 7101-4216-() | 2,487 | 3,847 | 3" | 22" Square | 66 lbs. |
| | 7101-4816-() | 2,569 | 4,345 | 3" | 22" Square | 72 lbs. |
|  <p>Round Top, 18" Height</p> | 7101-4818-() | 2,624 | 4,400 | 4" | 22" Square | 75 lbs. |

OPTIONS

-PFM02 Premium Metal Base Finish \$101

All shipments for this series will be blanket-wrapped as standard. If cartoning is required, a 20% upcharge will be added to each product. Please contact client services for additional information.

STRING GAMES MEETING TABLES | Designed by Madsen & Contois



SPECIFICATIONS:

- Available in two heights: 29" and 42".
- Depth options include: 24", 30" and 36".
- Length sizes include: 60", 72", 84" and 96".
- Tables offered in wood veneer, laminate and solid surface.
- Solid surface available in white only.
- To order a non-standard solid surface color, please specify the manufacturer, pattern name and color number. Please contact client services to confirm pricing.
- **Interior and exterior metal accents are featured as standard.**
- Also offered without interior and exterior metal accents, in various combinations, at no charge. Please refer to specific pages for options.
- Metal accents available in standard and premium finishes. See following page for options.
- For custom metal finish colors, please contact client services for pricing.
- Tables feature black reveal between top edge of panels and table-top.
- When specifying white laminate or solid surface, reveal will be white.
- For tables intended to be placed end-to-end, please select applicable option code without exterior metal accents (-MA0) or with exterior metal accent on single side only (-MA3).
- Panel bases and underside of tables feature removable panels for wire management accessibility.
- All panel bases feature adjustable glides as standard for leveling purposes.
- Ships KD. Assembly required.
- To ship fully assembled, set-up charge will be \$500 List per unit
- Please note that Canadian shipments are unable to be shipped blanket-wrapped and a 20% cartoning surcharge will always apply.
- Optional power units available. Please refer to pages 5-8 for options.
- All dimensions are nominal.
- Refer to terms and conditions for general information regarding finishes, warranty, freight, complete condition of sales and more.

STRING GAMES MEETING TABLES | Designed by Madsen & Contois

VENEER TABLE FEATURES:

- Three wood species available: Ash, Maple and Walnut.
- Premium wood finish upcharge applies to the following wood finishes. Refer to option section for pricing.
 - Super Matte Sable Maple
 - Alabaster Ash
 - Super Matte Sable Ash
- For custom wood finishes, please contact client services and add one-time upcharge of \$531 List per color per order.
- Due to natural variations of grain and color in woods, slight variations may occur.
- Veneer direction will run lengthwise on all table sizes.
- Edge finish will match top finish unless specified otherwise.

LAMINATE TABLE FEATURES:

- Laminate available in all standard colors.
- If white laminate is desired for top and panel bases, it is recommended to utilize Formica 949-58 White Matte with a ColorCore® 2 edge detail in matching 949C-58 White Matte to eliminate the black line that occurs with traditional laminates. Please specify and add \$354 List to the laminate pricing column.
- For custom laminate options, add \$649 List per color per order. Pre-approval required, please contact client services.
- Laminate wood grain direction will run lengthwise on all table sizes.
- Self edge standard, unless otherwise specified (laminate applied to edge).

SOLID SURFACE TABLE FEATURES:

- Solid surface is affixed to table top only (not available on table edges or panel bases). Please note that a 1/8" reveal will be present.
- Solid surface available in white only.
- To order a non-standard solid surface color, please specify the manufacturer, pattern name and color number. Contact client services to confirm pricing.
- Please specify wood or laminate finish for the table interior surface and panel bases, which will also be applied to the edge.

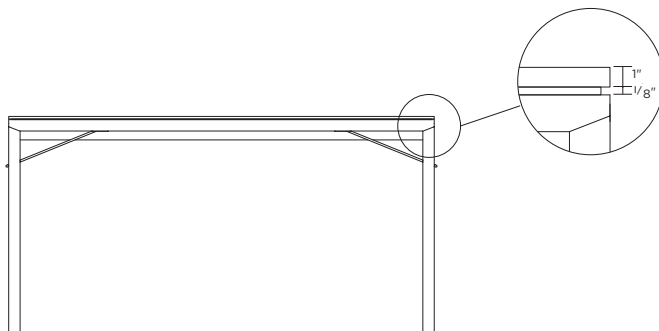

STANDARD METAL ACCENT FINISH COLORS:

- 0405 Charcoal Grey
- 0535 Metallic Silver
- 0199 Chrome
- 0630 Satin Black

PREMIUM METAL ACCENT FINISH COLORS:

- 0605 Matte Black
- 0705 Matte Cotton
- 0788 Glossy Cotton
- 0805 Oasis
- 0905 Mint
- 1005 Mercury
- 1105 Canary
- 1205 Stone
- 1305 Sage
- 1405 Ice Blue
- 1505 Clay

All shipments for this series will be blanket-wrapped as standard. If cartoning is required, a 20% upcharge will be added to each product. Please contact client services for additional information.

STRING GAMES MEETING TABLES | Designed by Madsen & Contois

ORDERING REQUIREMENTS:

- Model number
- Surface material
- Surface finish
- Metal accent finish
- Options, as applicable

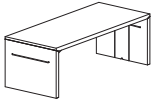
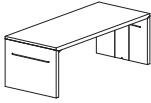
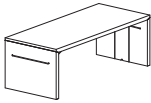
| MODEL | DIMENSIONS | LAMINATE | MAPLE VENEER | ASH OR WALNUT VENEER | SOLID SURFACE <small>Add upcharge to applicable wood species column</small> | WEIGHT <small>For veneer, laminate and ColorCore 2 tables only</small> | |
|--|-------------|-----------------------|--------------|----------------------|--|---|----------|
|  Interior/Exterior Metal Accents 24" Depth, 29" Height | 8122-246029 | 24" D x 60" L x 29" H | 5,558 | 5,726 | 6,728 | 1,110 | 149 lbs. |
| | 8122-247229 | 24" D x 72" L x 29" H | 6,025 | 6,207 | 7,375 | 1,332 | 165 lbs. |
| | 8122-248429 | 24" D x 84" L x 29" H | 6,347 | 6,537 | 7,700 | 1,554 | 172 lbs. |
| | 8122-249629 | 24" D x 96" L x 29" H | 6,629 | 6,829 | 7,993 | 1,776 | 179 lbs. |
|  Interior/Exterior Metal Accents 30" Depth, 29" Height | 8122-306029 | 30" D x 60" L x 29" H | 6,254 | 6,441 | 7,776 | 1,388 | 160 lbs. |
| | 8122-307229 | 30" D x 72" L x 29" H | 6,547 | 6,744 | 8,068 | 1,665 | 176 lbs. |
| | 8122-308429 | 30" D x 84" L x 29" H | 6,880 | 7,087 | 8,411 | 1,943 | 182 lbs. |
| | 8122-309629 | 30" D x 96" L x 29" H | 7,207 | 7,423 | 8,743 | 2,220 | 190 lbs. |
|  Interior/Exterior Metal Accents 36" Depth, 29" Height | 8122-366029 | 36" D x 60" L x 29" H | 6,177 | 6,363 | 7,353 | 1,665 | 171 lbs. |
| | 8122-367229 | 36" D x 72" L x 29" H | 6,734 | 6,938 | 8,090 | 1,998 | 187 lbs. |
| | 8122-368429 | 36" D x 84" L x 29" H | 7,112 | 7,326 | 8,476 | 2,331 | 193 lbs. |
| | 8122-369629 | 36" D x 96" L x 29" H | 7,444 | 7,669 | 8,808 | 2,664 | 202 lbs. |

OPTIONS

| | | |
|--------|--|-------|
| -PFM02 | Premium Metal Finish | \$101 |
| -PFW06 | Premium Wood Finish | \$311 |
| -MA0 | No Metal Accents | n/c |
| -MA2 | Interior Metal Accents Only | n/c |
| -MA3 | Interior Metal Accents - Both Sides Exterior Metal Accent - Single Side | n/c |

MA0



No Metal Accents

MA2



Interior Metal Accents Only

MA3



Interior Metal Accents - Both Sides
Exterior Metal Accents - Single Side

All shipments for this series will be blanket-wrapped as standard. If cartoning is required, a 20% upcharge will be added to each product. Please contact client services for additional information.

STRING GAMES MEETING TABLES | Designed by Madsen & Contois

ORDERING REQUIREMENTS:

- Model number
- Surface material
- Surface finish
- Metal accent finish
- Options, as applicable

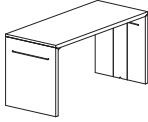
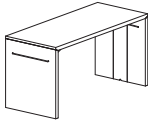
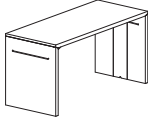
| MODEL | DIMENSIONS | LAMINATE | MAPLE VENEER | ASH OR WALNUT VENEER | SOLID SURFACE <small>Add upcharge to applicable wood species column</small> | WEIGHT <small>For veneer, laminate and ColorCore 2 tables only</small> | |
|---|-------------|-----------------------|--------------|----------------------|--|---|----------|
|  <p>Interior/Exterior Metal Accents 24" Depth, 42" Height</p> | 8122-246042 | 24" D x 60" L x 42" H | 6,413 | 6,606 | 7,941 | 1,110 | 157 lbs. |
| | 8122-247242 | 24" D x 72" L x 42" H | 6,695 | 6,897 | 8,234 | 1,332 | 173 lbs. |
| | 8122-248442 | 24" D x 84" L x 42" H | 6,992 | 7,203 | 8,530 | 1,554 | 180 lbs. |
| | 8122-249642 | 24" D x 96" L x 42" H | 7,275 | 7,493 | 8,820 | 1,776 | 189 lbs. |
|  <p>Interior/Exterior Metal Accents 30" Depth, 42" Height</p> | 8122-306042 | 30" D x 60" L x 42" H | 7,438 | 7,661 | 9,657 | 1,388 | 168 lbs. |
| | 8122-307242 | 30" D x 72" L x 42" H | 7,773 | 8,006 | 9,999 | 1,665 | 184 lbs. |
| | 8122-308442 | 30" D x 84" L x 42" H | 8,106 | 8,350 | 10,342 | 1,943 | 190 lbs. |
| | 8122-309642 | 30" D x 96" L x 42" H | 8,398 | 8,650 | 10,633 | 2,220 | 199 lbs. |
|  <p>Interior/Exterior Metal Accents 36" Depth, 42" Height</p> | 8122-366042 | 36" D x 60" L x 42" H | 8,295 | 8,544 | 11,039 | 1,665 | 179 lbs. |
| | 8122-367242 | 36" D x 72" L x 42" H | 8,636 | 8,895 | 11,378 | 1,998 | 195 lbs. |
| | 8122-368442 | 36" D x 84" L x 42" H | 9,022 | 9,292 | 11,774 | 2,331 | 201 lbs. |
| | 8122-369642 | 36" D x 96" L x 42" H | 9,394 | 9,676 | 12,157 | 2,664 | 211 lbs. |

OPTIONS

| | | |
|--------|--|-------|
| -PFM02 | Premium Metal Finish | \$101 |
| -PFW06 | Premium Wood Finish | \$311 |
| -MA0 | No Metal Accents | n/c |
| -MA2 | Interior Metal Accents Only | n/c |
| -MA3 | Interior Metal Accents - Both Sides Exterior Metal Accent - Single Side | n/c |

MA0



No Metal Accents

MA2



Interior Metal Accents Only

MA3



Interior Metal Accents - Both Sides
Exterior Metal Accents - Single Side

All shipments for this series will be blanket-wrapped as standard. If cartoning is required, a 20% upcharge will be added to each product. Please contact client services for additional information.

STRING GAMES MEETING TABLES - POWER UNITS | Designed by Madsen & Contois

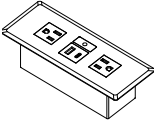

- Unit below is corded and available for top surface and/or side-mount placement. Refer to pages 6-7 for daisy chain options.
- Side-mount placement available on outside of panel bases and can only be added to tables without exterior metal accent. Power unit will be positioned vertically and includes matching wood cover on panel base interior.
- Please specify if power unit is to be placed on table top or outside base panel.
- Cord length should be taken into account when specifying electrical placement.
- Power source location must be identified.
- For single power unit placed on table top, location will be centered as standard.
- For panel base placement, refer to page 8 for power unit standard locations.
- Panel bases and underside of tables feature removable panels for wire management accessibility.
- To add power cord exit to the exterior base panel, please specify -"PC02" and add \$75 List.

| MODEL | DESCRIPTION | LIST |
|--|---|------------|
| <p>PX4-B, Black Finish PX4-W, White Finish</p>  | <p>Power Matrix 4</p> <ul style="list-style-type: none"> ■ Dimensions: 7.25" W x 2.875" D ■ Two simplex outlets, one USB-A and one USB-C charging port. ■ 120" electrical cord. ■ UL listed. | <p>559</p> |

All shipments for this series will be blanket-wrapped as standard. If cartoning is required, a 20% upcharge will be added to each product. Please contact client services for additional information.

STRING GAMES MEETING TABLES - DAISY CHAIN COMPONENTS | Designed by Madsen & Contois

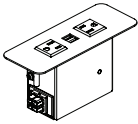

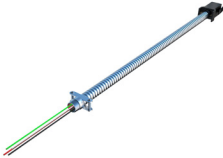
- Daisy chain units are required when more than one electrical unit is specified on one top.
- To determine jumper cable length, measure length from edge of electrical unit to end of table.
- Every connection point must be a female-to-male or male-to-female connection (all daisy chain power units feature male ends).

| MODEL | DESCRIPTION | LIST | | | | | | | | | | | | |
|--|---|-------|--------|------|-------------|-----|-----|--------------|------|-----|--------------|------|-----|-----------|
| PB3-DC-S, Silver Finish PB3-DC-W, White Finish  | Power Band 3 Daisy Chain <ul style="list-style-type: none"> ■ Dimensions: 6.5" W x 2.5" D ■ Two (2) simplex outlets and two (2) USB charging ports. ■ UL listed. | 724 | | | | | | | | | | | | |
| PB-ST-CD-72  | Power Band Starter Cable, 72" Long, Corded Plug Infeed <ul style="list-style-type: none"> ■ Must select either corded or hardwire starter cable, which goes from power source in wall or floor to first Power Band Unit. | 312 | | | | | | | | | | | | |
| PB-ST-HW-()  | Power Band Starter Cable, Hardwire Infeed <ul style="list-style-type: none"> ■ Must select either corded or hardwire starter cable, which goes from power source in wall or floor to first Power Band Unit. <table border="1"> <thead> <tr> <th>MODEL</th> <th>LENGTH</th> <th>LIST</th> </tr> </thead> <tbody> <tr> <td>PB-ST-HW-72</td> <td>72"</td> <td>216</td> </tr> <tr> <td>PB-ST-HW-108</td> <td>108"</td> <td>249</td> </tr> <tr> <td>PB-ST-HW-120</td> <td>120"</td> <td>277</td> </tr> </tbody> </table> | MODEL | LENGTH | LIST | PB-ST-HW-72 | 72" | 216 | PB-ST-HW-108 | 108" | 249 | PB-ST-HW-120 | 120" | 277 | see table |
| MODEL | LENGTH | LIST | | | | | | | | | | | | |
| PB-ST-HW-72 | 72" | 216 | | | | | | | | | | | | |
| PB-ST-HW-108 | 108" | 249 | | | | | | | | | | | | |
| PB-ST-HW-120 | 120" | 277 | | | | | | | | | | | | |

All shipments for this series will be blanket-wrapped as standard. If cartoning is required, a 20% upcharge will be added to each product. Please contact client services for additional information.

STRING GAMES MEETING TABLES - DAISY CHAIN COMPONENTS | Designed by Madsen & Contois

- Daisy chain units are required when more than one electrical unit is specified on one top.
- To determine jumper cable length, measure length from edge of electrical unit to end of table.
- Every connection point must be a female-to-male or male-to-female connection (all daisy chain power units feature male ends).

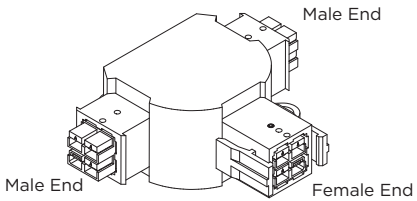
| MODEL | DESCRIPTION | LIST | | | | | | | | | | | | | | | | | | | | | | | | | | | |
|---|---|-------|--------|------|----------|-----|-----|----------|-----|-----|----------|-----|-----|----------|-----|-----|----------|-----|-----|----------|-----|-----|----------|-----|-----|----------|-----|-----|-----------|
| PB-FF-()  | Power Band Jumper Cables, Female to Female <ul style="list-style-type: none"> ■ Typically used to connect two (2) units together. ■ For additional lengths in 12" increments, please add \$25 List per foot. <table border="1"> <thead> <tr> <th>MODEL</th> <th>LENGTH</th> <th>LIST</th> </tr> </thead> <tbody> <tr><td>PB-FF-12</td><td>12"</td><td>147</td></tr> <tr><td>PB-FF-24</td><td>24"</td><td>161</td></tr> <tr><td>PB-FF-30</td><td>30"</td><td>175</td></tr> <tr><td>PB-FF-36</td><td>36"</td><td>175</td></tr> <tr><td>PB-FF-48</td><td>48"</td><td>188</td></tr> <tr><td>PB-FF-54</td><td>54"</td><td>195</td></tr> <tr><td>PB-FF-60</td><td>60"</td><td>203</td></tr> <tr><td>PB-FF-72</td><td>72"</td><td>216</td></tr> </tbody> </table> | MODEL | LENGTH | LIST | PB-FF-12 | 12" | 147 | PB-FF-24 | 24" | 161 | PB-FF-30 | 30" | 175 | PB-FF-36 | 36" | 175 | PB-FF-48 | 48" | 188 | PB-FF-54 | 54" | 195 | PB-FF-60 | 60" | 203 | PB-FF-72 | 72" | 216 | see table |
| MODEL | LENGTH | LIST | | | | | | | | | | | | | | | | | | | | | | | | | | | |
| PB-FF-12 | 12" | 147 | | | | | | | | | | | | | | | | | | | | | | | | | | | |
| PB-FF-24 | 24" | 161 | | | | | | | | | | | | | | | | | | | | | | | | | | | |
| PB-FF-30 | 30" | 175 | | | | | | | | | | | | | | | | | | | | | | | | | | | |
| PB-FF-36 | 36" | 175 | | | | | | | | | | | | | | | | | | | | | | | | | | | |
| PB-FF-48 | 48" | 188 | | | | | | | | | | | | | | | | | | | | | | | | | | | |
| PB-FF-54 | 54" | 195 | | | | | | | | | | | | | | | | | | | | | | | | | | | |
| PB-FF-60 | 60" | 203 | | | | | | | | | | | | | | | | | | | | | | | | | | | |
| PB-FF-72 | 72" | 216 | | | | | | | | | | | | | | | | | | | | | | | | | | | |
| PB-FM-()  | Power Band Jumper Cables, Female to Male <ul style="list-style-type: none"> ■ Typically used to connect two (2) units together. ■ For additional lengths in 12" increments, please add \$25 List per foot. <table border="1"> <thead> <tr> <th>MODEL</th> <th>LENGTH</th> <th>LIST</th> </tr> </thead> <tbody> <tr><td>PB-FM-12</td><td>12"</td><td>147</td></tr> <tr><td>PB-FM-24</td><td>24"</td><td>161</td></tr> <tr><td>PB-FM-30</td><td>30"</td><td>175</td></tr> <tr><td>PB-FM-36</td><td>36"</td><td>175</td></tr> <tr><td>PB-FM-48</td><td>48"</td><td>188</td></tr> <tr><td>PB-FM-54</td><td>54"</td><td>195</td></tr> <tr><td>PB-FM-60</td><td>60"</td><td>203</td></tr> <tr><td>PB-FM-72</td><td>72"</td><td>216</td></tr> </tbody> </table> | MODEL | LENGTH | LIST | PB-FM-12 | 12" | 147 | PB-FM-24 | 24" | 161 | PB-FM-30 | 30" | 175 | PB-FM-36 | 36" | 175 | PB-FM-48 | 48" | 188 | PB-FM-54 | 54" | 195 | PB-FM-60 | 60" | 203 | PB-FM-72 | 72" | 216 | see table |
| MODEL | LENGTH | LIST | | | | | | | | | | | | | | | | | | | | | | | | | | | |
| PB-FM-12 | 12" | 147 | | | | | | | | | | | | | | | | | | | | | | | | | | | |
| PB-FM-24 | 24" | 161 | | | | | | | | | | | | | | | | | | | | | | | | | | | |
| PB-FM-30 | 30" | 175 | | | | | | | | | | | | | | | | | | | | | | | | | | | |
| PB-FM-36 | 36" | 175 | | | | | | | | | | | | | | | | | | | | | | | | | | | |
| PB-FM-48 | 48" | 188 | | | | | | | | | | | | | | | | | | | | | | | | | | | |
| PB-FM-54 | 54" | 195 | | | | | | | | | | | | | | | | | | | | | | | | | | | |
| PB-FM-60 | 60" | 203 | | | | | | | | | | | | | | | | | | | | | | | | | | | |
| PB-FM-72 | 72" | 216 | | | | | | | | | | | | | | | | | | | | | | | | | | | |
| PB-T  | Power Band T-Connector <ul style="list-style-type: none"> ■ Used when power is needed to go in two directions. ■ Two (2) male ends and one (1) female end.  | 195 | | | | | | | | | | | | | | | | | | | | | | | | | | | |

All shipments for this series will be blanket-wrapped as standard. If cartoning is required, a 20% upcharge will be added to each product. Please contact client services for additional information.

STRING GAMES MEETING TABLES - POWER UNIT PLACEMENT | Designed by Madsen & Contois

Table Top Positioning

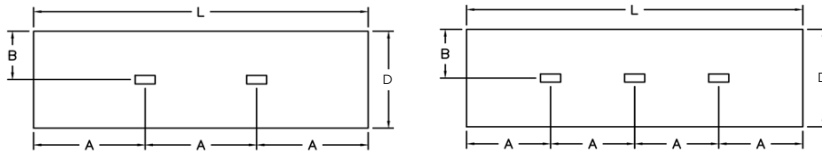

Panel Base (outside only, without exterior metal accent)

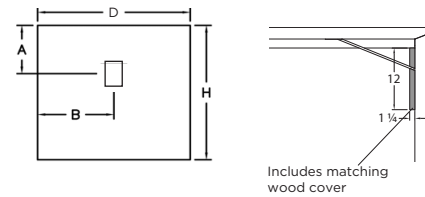

2 Power Units

| W x L | A | B |
|-----------|-----|-----|
| 24" x 60" | 20" | 12" |
| 24" x 72" | 24" | 12" |
| 24" x 84" | 28" | 12" |
| 24" x 96" | 32" | 12" |
| 30" x 60" | 20" | 15" |
| 30" x 72" | 24" | 15" |
| 30" x 84" | 28" | 15" |
| 30" x 96" | 32" | 15" |
| 36" x 60" | 20" | 18" |
| 36" x 72" | 24" | 18" |
| 36" x 84" | 28" | 18" |
| 36" x 96" | 32" | 18" |

3 Power Units

| W x L | A | B |
|-----------|-----|-----|
| 24" x 60" | 15" | 12" |
| 24" x 72" | 18" | 12" |
| 24" x 84" | 21" | 12" |
| 24" x 96" | 24" | 12" |
| 30" x 60" | 15" | 15" |
| 30" x 72" | 18" | 15" |
| 30" x 84" | 21" | 15" |
| 30" x 96" | 24" | 15" |
| 36" x 60" | 15" | 18" |
| 36" x 72" | 18" | 18" |
| 36" x 84" | 21" | 18" |
| 36" x 96" | 24" | 18" |

1 Power Unit

| W x L | A | B |
|-----------|-------|-----|
| 24" x 29" | 8.75" | 12" |
| 30" x 29" | 8.75" | 15" |
| 36" x 29" | 8.75" | 18" |
| 24" x 42" | 8.75" | 12" |
| 30" x 42" | 8.75" | 15" |
| 36" x 42" | 8.75" | 18" |

For custom power unit placement, please contact client services to verify that location can be accommodated.

All shipments for this series will be blanket-wrapped as standard. For customers located in Territory 1 who require cartoning, a 5% upcharge will be added to each product. Please contact client services for additional information.

SUITE GUEST + TANDEM | Designed by David Dahl



PRODUCT FEATURES:



ARM CAPS:

- Field-replaceable arm caps available on all models.



PASSIVE-FLEX BACK:

- Featured on all models.
- Passive-flex back motion provides long-term seated comfort.



CLEAN-OUT:

- Featured on all seating units, with the exception of models 7510 and 7515.
- Clean-out area between seat and back enables crumbs and other debris to fall through for maintenance ease.



METAL SEAT FRAME:

- Metal seat frame construction ensures durability and allows in-field component replacement as well as add-on capability for tandem units.



OPTIONAL REPLACEABLE UPHOLSTERY:

- Available on seats and backs of all models.
- Replacement seat and back covers can be easily field installed on previously ordered Suite models with standard fixed upholstery. Contact client services for instructions.

SUITE GUEST + TANDEM | Designed by David Dahl

PRODUCT FEATURES, CONTINUED:

- Wall-saver leg design.
- Three standard frame finish options. Refer to options below.
- All dimensions are nominal.
- Refer to terms and conditions for general information regarding fabrics, finishes, warranty, freight, complete condition of sales and more.

GUEST/TANDEM SEATING:

- Arm and armless guest and tandem models.
- Tandem models available in two and three-seat combinations or as reconfigurable modular units.
- Modular units offered with or without center arms.
- Three arm cap options: Beech wood, black urethane or solid surface.
- Wood arm caps available in all standard finishes on Beech.
- For Super Matte Sable Beech, upcharge applies. Refer to options section for pricing.
- For custom wood finishes, please add \$531 List per color per order.
- Solid surface arm caps available in white only.
- Tubular steel frame offered in three standard finishes. Refer to options below.
- 350 lb. weight capacity.
- VCT tile glides available for hard surface floors. Refer to individual pages for pricing.
- Include layout drawings or sketch with each tandem order.

CONNECTING TABLES:

- Three standard inline table options: 15" wide, 22" wide and 90-degree.
- End table offered in 22" width only.
- Wood veneer, laminate and solid surface top surface options.
- Wood top available in all standard finishes on Beech.
- For Super Matte Sable Beech, upcharge applies. Refer to options section for pricing.
- For custom wood finishes, please contact client services and add one-time upcharge of \$531 List per color per order.
- For custom laminate options, add \$649 List per color per order. Pre-approval required, please contact client services.
- Solid surface available in white only.
- Laminate tops are $\frac{3}{4}$ " thick. Solid surface tops are $\frac{1}{2}$ " thick over a $\frac{1}{2}$ " thick wood substrate.
- For all table widths, wood grain laminates will run parallel to width of table.
- Self edge standard.
- Tables are field installed.
- Please include layout drawings or sketch with each tandem order.

STANDARD METAL FRAME FINISH COLORS:





- 0405 Charcoal Grey
- 0535 Metallic Silver
- 0199 Chrome

All shipments for this series will be blanket-wrapped as standard. For customers located in Territory 1 who require cartoning, a 5% upcharge will be added to each product. Please contact client services for additional information.

SUITE GUEST + TANDEM | Designed by David Dahl

ORDERING REQUIREMENTS:

- Model number
- Arm cap finish, as applicable
- Frame finish
- Upholstery selection
- Options, as applicable

| MODEL | PRODUCT SPECIFICATIONS | FABRIC GRADES | | | | | | | | LEATHER | | | |
|---|--|---------------|-------|-------|-------|-------|-------|----------|-------|---------|-------|-------|-------|
| | | COM | A | 1 | 2 | 3 | 4 | COL 5 | 6 | 7 | 8 | L1 | L2 |
| 7510  | Guest Chair, Armless 21" W x 25.5" D x 31.75" H Seat: 19" W x 18.5" D Seat Ht: 18" COM: 1.5 yds. COL: 30 sq. ft. 25 lbs. | 1,506 | 1,608 | 1,662 | 1,695 | 1,748 | 1,805 | 1,856 | 1,908 | 1,961 | 2,015 | 2,262 | 2,442 |
| 7515-U  | Guest Chair, Black Urethane Arm Caps 21.75" W x 25.5" D x 31.75" H Seat: 19" W x 18.5" D Seat Ht: 18" Arm Ht: 25.75" COM: 1.5 yds. COL: 30 sq. ft. 26 lbs. | 1,577 | 1,679 | 1,733 | 1,766 | 1,819 | 1,876 | 1,927 | 1,979 | 2,032 | 2,086 | 2,333 | 2,513 |
| 7515-W  | Guest Chair, Wood Arm Caps 21.75" W x 25.5" D x 31.75" H Seat: 19" W x 18.5" D Seat Ht: 18" Arm Ht: 25.75" COM: 1.5 yds. COL: 30 sq. ft. 26 lbs. | 1,577 | 1,679 | 1,733 | 1,766 | 1,819 | 1,876 | 1,927 | 1,979 | 2,032 | 2,086 | 2,333 | 2,513 |
| 7515-SF  | Guest Chair, Solid Surface Arm Caps 21.75" W x 25.5" D x 31.75" H Seat: 19" W x 18.5" D Seat Ht: 18" Arm Ht: 25.75" COM: 1.5 yds. COL: 30 sq. ft. 26 lbs. | 1,919 | 2,021 | 2,075 | 2,108 | 2,161 | 2,218 | 2,269 | 2,321 | 2,374 | 2,428 | 2,675 | 2,855 |

OPTIONS





| | | |
|--------|--|------|
| -PFW01 | Premium Wood Finish, Arm Cap (per arm) | \$12 |
| -SC01 | Replaceable Seat Cover (per seat) | \$60 |
| -BC01 | Replaceable Back Cover (per back) | \$60 |
| -MB01 | Moisture Barrier (seat only) | \$68 |
| -VCT04 | VCT Tile Glides | \$28 |

All shipments for this series will be blanket-wrapped as standard. For customers located in Territory 1 who require cartoning, a 5% upcharge will be added to each product. Please contact client services for additional information.

SUITE GUEST + TANDEM | Designed by David Dahl

ORDERING REQUIREMENTS:

- Model number
- Arm cap finish, as applicable
- Frame finish
- Upholstery selection
- Options, as applicable

| MODEL | PRODUCT SPECIFICATIONS | FABRIC GRADES | | | | | | | | LEATHER | | | |
|--|--|---------------|-------|-------|-------|-------|-------|----------|-------|---------|-------|-------|-------|
| | | COM | A | 1 | 2 | 3 | 4 | COL 5 | 6 | 7 | 8 | L1 | L2 |
| 7511  | Guest Chair with Cleanout, Armless 21" W x 25.5" D x 31.75" H Seat: 19" W x 18.5" D Seat Ht: 18" COM: 1.5 yds. COL: 30 sq. ft. 25 lbs. | 1,570 | 1,672 | 1,726 | 1,759 | 1,812 | 1,869 | 1,920 | 1,972 | 2,025 | 2,079 | 2,326 | 2,506 |
| 7521-U  | Guest Chair with Cleanout, Black Urethane Arm Caps 21.75" W x 25.5" D x 31.75" H Seat: 19" W x 18.5" D Seat Ht: 18" Arm Ht: 25.75" COM: 1.5 yds. COL: 30 sq. ft. 26 lbs. | 1,643 | 1,745 | 1,799 | 1,832 | 1,885 | 1,942 | 1,993 | 2,045 | 2,098 | 2,152 | 2,399 | 2,579 |
| 7521-W  | Guest Chair with Cleanout, Wood Arm Caps 21.75" W x 25.5" D x 31.75" H Seat: 19" W x 18.5" D Seat Ht: 18" Arm Ht: 25.75" COM: 1.5 yds. COL: 30 sq. ft. 26 lbs. | 1,643 | 1,745 | 1,799 | 1,832 | 1,885 | 1,942 | 1,993 | 2,045 | 2,098 | 2,152 | 2,399 | 2,579 |
| 7521-SF  | Guest Chair with Cleanout, Solid Surface Caps 21.75" W x 25.5" D x 31.75" H Seat: 19" W x 18.5" D Seat Ht: 18" Arm Ht: 25.75" COM: 1.5 yds. COL: 30 sq. ft. 26 lbs. | 1,985 | 2,087 | 2,141 | 2,174 | 2,227 | 2,284 | 2,335 | 2,387 | 2,440 | 2,494 | 2,741 | 2,921 |

OPTIONS



| | |
|---|------|
| -PFW01 Premium Wood Finish, Arm Cap (per arm) | \$12 |
| -SC01 Replaceable Seat Cover (per seat) | \$60 |
| -BC01 Replaceable Back Cover (per back) | \$60 |
| -MB01 Moisture Barrier (seat only) | \$68 |
| -VCT04 VCT Tile Glides | \$28 |

All shipments for this series will be blanket-wrapped as standard. For customers located in Territory 1 who require cartoning, a 5% upcharge will be added to each product. Please contact client services for additional information.

SUITE GUEST + TANDEM | Designed by David Dahl

ORDERING REQUIREMENTS:

- Model number
- Arm cap finish, as applicable
- Frame finish
- Upholstery selection
- Options, as applicable

| MODEL | PRODUCT SPECIFICATIONS | FABRIC GRADES | | | | | | | | | | LEATHER | |
|---------|--|---------------|-------|-------|-------|-------|-------|----------|-------|-------|-------|---------|-------|
| | | COM | A | 1 | 2 | 3 | 4 | COL 5 | 6 | 7 | 8 | L1 | L2 |
| 7522-U |  <p>Tandem Two-Seater, Black Urethane Arm Caps 42" W x 25.5" D x 31.75" H Seat: 19" W x 18.5" D Seat Ht: 18" Arm Ht: 25.75" COM: 3 yds. COL: 60 sq. ft. 48 lbs.</p> | 2,977 | 3,181 | 3,289 | 3,355 | 3,460 | 3,574 | 3,676 | 3,781 | 3,886 | 3,994 | 4,489 | 4,849 |
| 7522-W |  <p>Tandem Two-Seater, Wood Arm Caps 42" W x 25.5" D x 31.75" H Seat: 19" W x 18.5" D Seat Ht: 18" Arm Ht: 25.75" COM: 3 yds. COL: 60 sq. ft. 48 lbs.</p> | 2,977 | 3,181 | 3,289 | 3,355 | 3,460 | 3,574 | 3,676 | 3,781 | 3,886 | 3,994 | 4,489 | 4,849 |
| 7522-SF |  <p>Tandem Two-Seater, Solid Surface Arm Caps 42" W x 25.5" D x 31.75" H Seat: 19" W x 18.5" D Seat Ht: 18" Arm Ht: 25.75" COM: 3 yds. COL: 60 sq. ft. 48 lbs.</p> | 3,490 | 3,694 | 3,802 | 3,868 | 3,973 | 4,087 | 4,189 | 4,294 | 4,399 | 4,507 | 5,002 | 5,362 |

OPTIONS

| | |
|---|-------|
| -PFW01 Premium Wood Finish, Arm Cap (per arm) | \$12 |
| -SC03 Replaceable Seat Cover (per two-seat unit) | \$126 |
| -BC03 Replaceable Back Cover (per two-seat unit) | \$126 |
| -MB04 Moisture Barrier (seat only, per two-seat unit) | \$126 |
| -VCT02 VCT Tile Glides (per arm frame) | \$14 |

All shipments for this series will be blanket-wrapped as standard. For customers located in Territory 1 who require cartoning, a 5% upcharge will be added to each product. Please contact client services for additional information.

SUITE GUEST + TANDEM | Designed by David Dahl

ORDERING REQUIREMENTS:

- Model number
- Arm cap finish, as applicable
- Frame finish
- Upholstery selection
- Options, as applicable

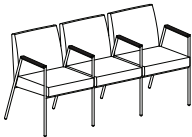
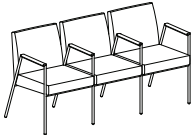
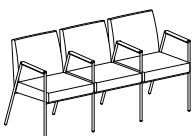
| MODEL | PRODUCT SPECIFICATIONS | FABRIC GRADES | | | | | | | | | | LEATHER | |
|---------|--|---------------|-------|-------|-------|-------|-------|----------|-------|-------|-------|---------|-------|
| | | COM | A | 1 | 2 | 3 | 4 | COL 5 | 6 | 7 | 8 | L1 | L2 |
| 7523-U |  <p>Tandem Three-Seater, Black Urethane Arm Caps 62" W x 25.5" D x 31.75" H Seat: 19" W x 18.5" D Seat Ht: 18" Arm Ht: 25.75" COM: 4.5 yds. COL: 90 sq. ft. 70 lbs.</p> | 4,391 | 4,697 | 4,859 | 4,958 | 5,116 | 5,287 | 5,440 | 5,597 | 5,755 | 5,917 | 6,659 | 7,199 |
| 7523-W |  <p>Tandem Three-Seater, Wood Arm Caps 62" W x 25.5" D x 31.75" H Seat: 19" W x 18.5" D Seat Ht: 18" Arm Ht: 25.75" COM: 4.5 yds. COL: 90 sq. ft. 70 lbs.</p> | 4,391 | 4,697 | 4,859 | 4,958 | 5,116 | 5,287 | 5,440 | 5,597 | 5,755 | 5,917 | 6,659 | 7,199 |
| 7523-SF |  <p>Tandem Three-Seater, Solid Surface Arm Caps 62" W x 25.5" D x 31.75" H Seat: 19" W x 18.5" D Seat Ht: 18" Arm Ht: 25.75" COM: 4.5 yds. COL: 90 sq. ft. 70 lbs.</p> | 5,075 | 5,381 | 5,543 | 5,642 | 5,800 | 5,971 | 6,124 | 6,281 | 6,439 | 6,601 | 7,343 | 7,883 |

OPTIONS

| | |
|---|-------|
| -PFW01 Premium Wood Finish, Arm Cap (per arm) | \$12 |
| -SC04 Replaceable Seat Cover (per three-seat unit) | \$189 |
| -BC04 Replaceable Back Cover (per three-seat unit) | \$189 |
| -MB05 Moisture Barrier (seat only, per three-seat unit) | \$189 |
| -VCT02 VCT Tile Glides (per arm frame) | \$14 |

All shipments for this series will be blanket-wrapped as standard. For customers located in Territory 1 who require cartoning, a 5% upcharge will be added to each product. Please contact client services for additional information.

SUITE GUEST + TANDEM | Designed by David Dahl

ORDERING GUIDELINES:

- To build tandem configurations, always specify units from left-to-right as facing.
- Starter units ("-ST") represent the first seating model in a configuration with subsequent modular units building onto them towards the right.
- Add-on units ("-AO") can only be added next to starter units or other add-on units.
- End-units ("-EU") represent the final seating model in a configuration.
- Center and corner tables are for in-line placement only (cannot start or end a configuration) and for specification purposes, will always come before a starter unit, after an end unit or before/after a single chair (i.e. add-on units cannot be specified next to connecting tables).
- End tables can only start or end a configuration, therefore they will always come before a starter unit or after an end unit (i.e. add-on units cannot be specified next to connecting tables).

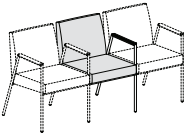
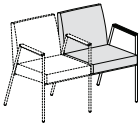
| MODEL | PRODUCT SPECIFICATIONS | FABRIC GRADES | | | | | | | | LEATHER | | | |
|---|--|---------------|-------|-------|-------|-------|-------|----------|-------|---------|-------|-------|-------|
| | | COM | A | 1 | 2 | 3 | 4 | COL 5 | 6 | 7 | 8 | L1 | L2 |
| 7520-ST-U  | Tandem Starter Unit, Black Urethane Arm Caps 21.75" W x 25.5" D x 31.75" H Seat: 19" W x 18.5" D Seat Ht: 18" Arm Ht: 25.75" COM: 1.5 yds. COL: 30 sq. ft. 26 lbs. | 1,640 | 1,742 | 1,796 | 1,829 | 1,882 | 1,939 | 1,990 | 2,042 | 2,095 | 2,149 | 2,396 | 2,576 |
| 7520-AO-U  | Tandem Add-On Unit, Black Urethane Arm Cap 20" W x 25.5" D x 31.75" H Seat: 19" W x 18.5" D Seat Ht: 18" Arm Ht: 25.75" COM: 1.5 yds. COL: 30 sq. ft. 22 lbs. | 1,468 | 1,570 | 1,624 | 1,657 | 1,710 | 1,767 | 1,818 | 1,870 | 1,923 | 1,977 | 2,224 | 2,404 |
| 7520-EU-U  | Tandem End Unit, Black Urethane Arm Cap 20" W x 25.5" D x 31.75" H Seat: 19" W x 18.5" D Seat Ht: 18" Arm Ht: 25.75" COM: 1.5 yds. COL: 30 sq. ft. 22 lbs. | 1,451 | 1,553 | 1,607 | 1,640 | 1,693 | 1,750 | 1,801 | 1,853 | 1,906 | 1,960 | 2,207 | 2,387 |

OPTIONS

| | | | | | |
|-------|--|------|--------|--|------|
| -SC01 | Replaceable Seat Cover (per seat) | \$60 | -VCT04 | VCT Tile Glides (starter unit) | \$28 |
| -BC01 | Replaceable Back Cover (per back) | \$60 | -VCT02 | VCT Tile Glides (add-on and end units) | \$14 |
| -MB01 | Moisture Barrier (seat only, per unit) | \$68 | | | |

All shipments for this series will be blanket-wrapped as standard. For customers located in Territory 1 who require cartoning, a 5% upcharge will be added to each product. Please contact client services for additional information.

SUITE GUEST + TANDEM | Designed by David Dahl

ORDERING GUIDELINES:

- To build tandem configurations, always specify units from left-to-right as facing.
- Starter units ("-ST") represent the first seating model in a configuration with subsequent modular units building onto them towards the right.
- Add-on units ("-AO") can only be added next to starter units or other add-on units.
- End-units ("-EU") represent the final seating model in a configuration.
- Center and corner tables are for in-line placement only (cannot start or end a configuration) and for specification purposes, will always come before a starter unit, after an end unit or before/after a single chair (i.e. add-on units cannot be specified next to connecting tables).
- End tables can only start or end a configuration, therefore they will always come before a starter unit or after an end unit (i.e. add-on units cannot be specified next to connecting tables).

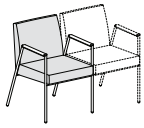
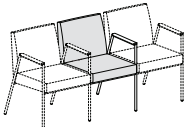
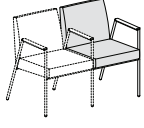
| MODEL | PRODUCT SPECIFICATIONS | FABRIC GRADES | | | | | | | | LEATHER | | | |
|---|--|---------------|-------|-------|-------|-------|-------|----------|-------|---------|-------|-------|-------|
| | | COM | A | 1 | 2 | 3 | 4 | COL 5 | 6 | 7 | 8 | L1 | L2 |
| 7520-ST-W  | Tandem Starter Unit, Wood Arm Caps 21.75" W x 25.5" D x 31.75" H Seat: 19" W x 18.5" D Seat Ht: 18" Arm Ht: 25.75" COM: 1.5 yds. COL: 30 sq. ft. 26 lbs. | 1,640 | 1,742 | 1,796 | 1,829 | 1,882 | 1,939 | 1,990 | 2,042 | 2,095 | 2,149 | 2,396 | 2,576 |
| 7520-AO-W  | Tandem Add-On Unit, Wood Arm Cap 20" W x 25.5" D x 31.75" H Seat: 19" W x 18.5" D Seat Ht: 18" Arm Ht: 25.75" COM: 1.5 yds. COL: 30 sq. ft. 22 lbs. | 1,468 | 1,570 | 1,624 | 1,657 | 1,710 | 1,767 | 1,818 | 1,870 | 1,923 | 1,977 | 2,224 | 2,404 |
| 7520-EU-W  | Tandem End Unit, Wood Arm Cap 20" W x 25.5" D x 31.75" H Seat: 19" W x 18.5" D Seat Ht: 18" Arm Ht: 25.75" COM: 1.5 yds. COL: 30 sq. ft. 22 lbs. | 1,451 | 1,553 | 1,607 | 1,640 | 1,693 | 1,750 | 1,801 | 1,853 | 1,906 | 1,960 | 2,207 | 2,387 |

OPTIONS

| | | | | | |
|--------|--|------|--------|--|------|
| -PFW01 | Premium Wood Finish, Arm Cap (per arm) | \$12 | -VCT04 | VCT Tile Glides (starter unit) | \$28 |
| -SC01 | Replaceable Seat Cover (per seat) | \$60 | -VCT02 | VCT Tile Glides (add-on and end units) | \$14 |
| -BC01 | Replaceable Back Cover (per back) | \$60 | | | |
| -MB01 | Moisture Barrier (seat only, per unit) | \$68 | | | |

All shipments for this series will be blanket-wrapped as standard. For customers located in Territory 1 who require cartoning, a 5% upcharge will be added to each product. Please contact client services for additional information.

SUITE GUEST + TANDEM | Designed by David Dahl

ORDERING GUIDELINES:

- To build tandem configurations, always specify units from left-to-right as facing.
- Starter units ("-ST") represent the first seating model in a configuration with subsequent modular units building onto them towards the right.
- Add-on units ("-AO") can only be added next to starter units or other add-on units.
- End-units ("-EU") represent the final seating model in a configuration.
- Center and corner tables are for in-line placement only (cannot start or end a configuration) and for specification purposes, will always come before a starter unit, after an end unit or before/after a single chair (i.e. add-on units cannot be specified next to connecting tables).
- End tables can only start or end a configuration, therefore they will always come before a starter unit or after an end unit (i.e. add-on units cannot be specified next to connecting tables).

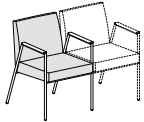
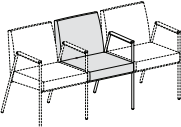
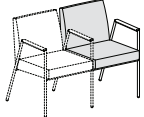
| MODEL | PRODUCT SPECIFICATIONS | FABRIC GRADES | | | | | | | | LEATHER | | | |
|--|---|---------------|-------|-------|-------|-------|-------|----------|-------|---------|-------|-------|-------|
| | | COM | A | 1 | 2 | 3 | 4 | COL 5 | 6 | 7 | 8 | L1 | L2 |
| 7520-ST-SF  | Tandem Starter Unit, Solid Surface Arm Caps 21.75" W x 25.5" D x 31.75" H Seat: 19" W x 18.5" D Seat Ht: 18" Arm Ht: 25.75" COM: 1.5 yds. COL: 30 sq. ft. 26 lbs. | 1,982 | 2,084 | 2,138 | 2,171 | 2,224 | 2,281 | 2,332 | 2,384 | 2,437 | 2,491 | 2,738 | 2,918 |
| 7520-AO-SF  | Tandem Add-On Unit, Solid Surface Arm Cap 20" W x 25.5" D x 31.75" H Seat: 19" W x 18.5" D Seat Ht: 18" Arm Ht: 25.75" COM: 1.5 yds. COL: 30 sq. ft. 22 lbs. | 1,810 | 1,912 | 1,966 | 1,999 | 2,052 | 2,109 | 2,160 | 2,212 | 2,265 | 2,319 | 2,566 | 2,746 |
| 7520-EU-SF  | Tandem End Unit, Solid Surface Arm Cap 20" W x 25.5" D x 31.75" H Seat: 19" W x 18.5" D Seat Ht: 18" Arm Ht: 25.75" COM: 1.5 yds. COL: 30 sq. ft. 22 lbs. | 1,622 | 1,724 | 1,778 | 1,811 | 1,864 | 1,921 | 1,972 | 2,024 | 2,077 | 2,131 | 2,378 | 2,558 |

OPTIONS



| | | | | | |
|-------|--|------|--------|--|------|
| -SC01 | Replaceable Seat Cover (per seat) | \$60 | -VCT04 | VCT Tile Glides (starter unit) | \$28 |
| -BC01 | Replaceable Back Cover (per back) | \$60 | -VCT02 | VCT Tile Glides (add-on and end units) | \$14 |
| -MB01 | Moisture Barrier (seat only, per unit) | \$68 | | | |

All shipments for this series will be blanket-wrapped as standard. For customers located in Territory 1 who require cartoning, a 5% upcharge will be added to each product. Please contact client services for additional information.

SUITE GUEST + TANDEM | Designed by David Dahl

ORDERING GUIDELINES:

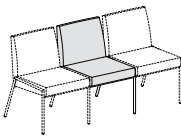
- To build tandem configurations, always specify units from left-to-right as facing.
- Starter units ("-ST") represent the first seating model in a configuration with subsequent modular units building onto them towards the right.
- Add-on units ("-AO") can only be added next to starter units or other add-on units.
- End-units ("-EU") represent the final seating model in a configuration.
- Center and corner tables are for in-line placement only (cannot start or end a configuration) and for specification purposes, will always come before a starter unit, after an end unit or before/after a single chair (i.e. add-on units cannot be specified next to connecting tables).
- End tables can only start or end a configuration, therefore they will always come before a starter unit or after an end unit (i.e. add-on units cannot be specified next to connecting tables).

| MODEL | PRODUCT SPECIFICATIONS | FABRIC GRADES | | | | | | | | | | LEATHER | |
|---|--|---------------|-------|-------|-------|-------|-------|----------|-------|-------|-------|---------|-------|
| | | COM | A | 1 | 2 | 3 | 4 | COL 5 | 6 | 7 | 8 | L1 | L2 |
| 7530-ST  | Tandem Starter Unit, Armless 21" W x 25.5" D x 31.75" H Seat: 19" W x 18.5" D Seat Ht: 18" COM: 1.5 yds. COL: 30 sq. ft. 25 lbs. | 1,456 | 1,558 | 1,612 | 1,645 | 1,698 | 1,755 | 1,806 | 1,858 | 1,911 | 1,965 | 2,212 | 2,392 |
| 7530-AO  | Tandem Add-On Unit, Armless 20.25" W x 25.5" D x 31.75" H Seat: 19" W x 18.5" D Seat Ht: 18" COM: 1.5 yds. COL: 30 sq. ft. 21 lbs. | 1,386 | 1,488 | 1,542 | 1,575 | 1,628 | 1,685 | 1,736 | 1,788 | 1,841 | 1,895 | 2,142 | 2,322 |
| 7530-EU  | Tandem End Unit, Armless 20.25" W x 25.5" D x 31.75" H Seat: 19" W x 18.5" D Seat Ht: 18" COM: 1.5 yds. COL: 30 sq. ft. 21 lbs. | 1,370 | 1,472 | 1,526 | 1,559 | 1,612 | 1,669 | 1,720 | 1,772 | 1,825 | 1,879 | 2,126 | 2,306 |

OPTIONS



| | | | | | |
|-------|--|------|--------|--|------|
| -SC01 | Replaceable Seat Cover (per seat) | \$60 | -VCT04 | VCT Tile Glides (starter unit) | \$28 |
| -BC01 | Replaceable Back Cover (per back) | \$60 | -VCT02 | VCT Tile Glides (add-on and end units) | \$14 |
| -MB01 | Moisture Barrier (seat only, per unit) | \$68 | | | |

All shipments for this series will be blanket-wrapped as standard. For customers located in Territory 1 who require cartoning, a 5% upcharge will be added to each product. Please contact client services for additional information.

SUITE GUEST + TANDEM | Designed by David Dahl

ORDERING GUIDELINES:

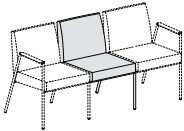
- To build tandem configurations, always specify units from left-to-right as facing.
- Starter units ("-ST") represent the first seating model in a configuration with subsequent modular units building onto them towards the right.
- Add-on units ("-AO") can only be added next to starter units or other add-on units.
- End-units ("-EU") represent the final seating model in a configuration.
- Center and corner tables are for in-line placement only (cannot start or end a configuration) and for specification purposes, will always come before a starter unit, after an end unit or before/after a single chair (i.e. add-on units cannot be specified next to connecting tables).
- End tables can only start or end a configuration, therefore they will always come before a starter unit or after an end unit (i.e. add-on units cannot be specified next to connecting tables).

| MODEL | PRODUCT SPECIFICATIONS | FABRIC GRADES | | | | | | | | LEATHER | | | |
|---|---|---------------|-------|-------|-------|-------|-------|----------|-------|---------|-------|-------|-------|
| | | COM | A | 1 | 2 | 3 | 4 | COL 5 | 6 | 7 | 8 | L1 | L2 |
| 7535-ST-U  | Tandem Starter Unit, Black Urethane Arm Cap, Armless 21.5" W x 25.5" D x 31.75" H Seat: 19" W x 18.5" D Seat Ht: 18" Arm Ht: 25.75" COM: 1.5 yds. COL: 30 sq. ft. 25 lbs. | 1,542 | 1,644 | 1,698 | 1,731 | 1,784 | 1,841 | 1,892 | 1,944 | 1,997 | 2,051 | 2,298 | 2,478 |
| 7530-AO  | Tandem Add-On Unit, Armless 20.25" W x 25.5" D x 31.75" H Seat: 19" W x 18.5" D Seat Ht: 18" COM: 1.5 yds. COL: 30 sq. ft. 21 lbs. | 1,386 | 1,488 | 1,542 | 1,575 | 1,628 | 1,685 | 1,736 | 1,788 | 1,841 | 1,895 | 2,142 | 2,322 |
| 7535-EU-U  | Tandem End Unit, Armless, Black Urethane Arm Cap 21.5" W x 25.5" D x 31.75" H Seat: 19" W x 18.5" D Seat Ht: 18" Arm Ht: 25.75" COM: 1.5 yds. COL: 30 sq. ft. 25 lbs. | 1,448 | 1,550 | 1,604 | 1,637 | 1,690 | 1,747 | 1,798 | 1,850 | 1,903 | 1,957 | 2,204 | 2,384 |

OPTIONS



| | | | | | |
|-------|--|------|--------|--|------|
| -SC01 | Replaceable Seat Cover (per seat) | \$60 | -VCT04 | VCT Tile Glides (starter unit) | \$28 |
| -BC01 | Replaceable Back Cover (per back) | \$60 | -VCT02 | VCT Tile Glides (add-on and end units) | \$14 |
| -MB01 | Moisture Barrier (seat only, per unit) | \$68 | | | |

All shipments for this series will be blanket-wrapped as standard. For customers located in Territory 1 who require cartoning, a 5% upcharge will be added to each product. Please contact client services for additional information.

SUITE GUEST + TANDEM | Designed by David Dahl

ORDERING GUIDELINES:

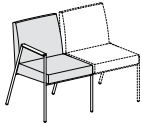
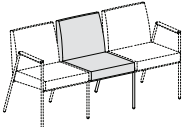
- To build tandem configurations, always specify units from left-to-right as facing.
- Starter units ("-ST") represent the first seating model in a configuration with subsequent modular units building onto them towards the right.
- Add-on units ("-AO") can only be added next to starter units or other add-on units.
- End-units ("-EU") represent the final seating model in a configuration.
- Center and corner tables are for in-line placement only (cannot start or end a configuration) and for specification purposes, will always come before a starter unit, after an end unit or before/after a single chair (i.e. add-on units cannot be specified next to connecting tables).
- End tables can only start or end a configuration, therefore they will always come before a starter unit or after an end unit (i.e. add-on units cannot be specified next to connecting tables).

| MODEL | PRODUCT SPECIFICATIONS | FABRIC GRADES | | | | | | | | LEATHER | | | |
|---|---|---------------|-------|-------|-------|-------|-------|----------|-------|---------|-------|-------|-------|
| | | COM | A | 1 | 2 | 3 | 4 | COL 5 | 6 | 7 | 8 | L1 | L2 |
| 7535-ST-W  | Tandem Starter Unit, Wood Arm Cap, Armless 21.5" W x 25.5" D x 31.75" H Seat: 19" W x 18.5" D Seat Ht: 18" Arm Ht: 25.75" COM: 1.5 yds. COL: 30 sq. ft. 25 lbs. | 1,542 | 1,644 | 1,698 | 1,731 | 1,784 | 1,841 | 1,892 | 1,944 | 1,997 | 2,051 | 2,298 | 2,478 |
| 7530-AO  | Tandem Add-On Unit, Armless 20.25" W x 25.5" D x 31.75" H Seat: 19" W x 18.5" D Seat Ht: 18" COM: 1.5 yds. COL: 30 sq. ft. 21 lbs. | 1,386 | 1,488 | 1,542 | 1,575 | 1,628 | 1,685 | 1,736 | 1,788 | 1,841 | 1,895 | 2,142 | 2,322 |
| 7535-EU-W  | Tandem End Unit, Armless, Wood Arm Cap 21.5" W x 25.5" D x 31.75" H Seat: 19" W x 18.5" D Seat Ht: 18" Arm Ht: 25.75" COM: 1.5 yds. COL: 30 sq. ft. 25 lbs. | 1,448 | 1,550 | 1,604 | 1,637 | 1,690 | 1,747 | 1,798 | 1,850 | 1,903 | 1,957 | 2,204 | 2,384 |

OPTIONS



| | | | |
|---|------|---|------|
| -PFW01 Premium Wood Finish, Arm Cap (per arm) | \$12 | -VCT04 VCT Tile Glides (starter unit) | \$28 |
| -SC01 Replaceable Seat Cover (per seat) | \$60 | -VCT02 VCT Tile Glides (add-on and end units) | \$14 |
| -BC01 Replaceable Back Cover (per back) | \$60 | | |
| -MB01 Moisture Barrier (seat only, per unit) | \$68 | | |

All shipments for this series will be blanket-wrapped as standard. For customers located in Territory 1 who require cartoning, a 5% upcharge will be added to each product. Please contact client services for additional information.

SUITE GUEST + TANDEM | Designed by David Dahl

ORDERING GUIDELINES:

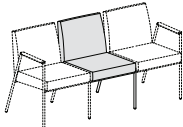
- To build tandem configurations, always specify units from left-to-right as facing.
- Starter units ("-ST") represent the first seating model in a configuration with subsequent modular units building onto them towards the right.
- Add-on units ("-AO") can only be added next to starter units or other add-on units.
- End-units ("-EU") represent the final seating model in a configuration.
- Center and corner tables are for in-line placement only (cannot start or end a configuration) and for specification purposes, will always come before a starter unit, after an end unit or before/after a single chair (i.e. add-on units cannot be specified next to connecting tables).
- End tables can only start or end a configuration, therefore they will always come before a starter unit or after an end unit (i.e. add-on units cannot be specified next to connecting tables).

| MODEL | PRODUCT SPECIFICATIONS | FABRIC GRADES | | | | | | | | LEATHER | | | |
|--|--|---------------|-------|-------|-------|-------|-------|----------|-------|---------|-------|-------|-------|
| | | COM | A | 1 | 2 | 3 | 4 | COL 5 | 6 | 7 | 8 | L1 | L2 |
| 7535-ST-SF  | Tandem Starter Unit, Solid Surface Arm Cap, Armless 21.5" W x 25.5" D x 31.75" H Seat: 19" W x 18.5" D Seat Ht: 18" Arm Ht: 25.75" COM: 1.5 yds. COL: 30 sq. ft. 25 lbs. | 1,884 | 1,986 | 2,040 | 2,073 | 2,126 | 2,183 | 2,234 | 2,286 | 2,339 | 2,393 | 2,640 | 2,820 |
| 7535-AO  | Tandem Add-On Unit, Armless 20.25" W x 25.5" D x 31.75" H Seat: 19" W x 18.5" D Seat Ht: 18" COM: 1.5 yds. COL: 30 sq. ft. 21 lbs. | 1,386 | 1,488 | 1,542 | 1,575 | 1,628 | 1,685 | 1,736 | 1,788 | 1,841 | 1,895 | 2,142 | 2,322 |
| 7535-EU-SF  | Tandem End Unit, Armless, Solid Surface Arm Cap 21.5" W x 25.25" D x 31.75" H Seat: 19" W x 18.5" D Seat Ht: 18" Arm Ht: 25.75" COM: 1.5 yds. COL: 30 sq. ft. 25 lbs. | 1,619 | 1,721 | 1,775 | 1,808 | 1,861 | 1,918 | 1,969 | 2,021 | 2,074 | 2,128 | 2,375 | 2,555 |

OPTIONS

| | | | | | |
|-------|--|------|--------|--|------|
| -SC01 | Replaceable Seat Cover (per seat) | \$60 | -VCT04 | VCT Tile Glides (starter unit) | \$28 |
| -BC01 | Replaceable Back Cover (per back) | \$60 | -VCT02 | VCT Tile Glides (add-on and end units) | \$14 |
| -MB01 | Moisture Barrier (seat only, per unit) | \$68 | | | |

All shipments for this series will be blanket-wrapped as standard. For customers located in Territory 1 who require cartoning, a 5% upcharge will be added to each product. Please contact client services for additional information.

SUITE GUEST + TANDEM | Designed by David Dahl

ORDERING REQUIREMENTS:

- Model number
- Top surface
- Top finish, as applicable
- Frame finish, as applicable
- Options, as applicable

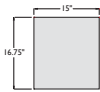
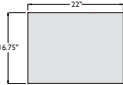
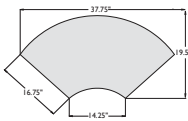
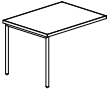
| MODEL | PRODUCT SPECIFICATIONS | WOOD (-W) OR LAMINATE TOP (-L) | SOLID SURFACE TOP (-SF) | WEIGHT |
|---|---|--------------------------------|-------------------------|---------|
| 7540-15-()  | 15" Wide Center Table 15" W x 16.75" D | 695 | 851 | 2 lbs. |
| 7540-22-()  | 22" Wide Center Table 22" W x 16.75" D | 787 | 1,016 | 3 lbs. |
| 7540-90-()  | 90-Degree Corner Table 37.75" W x 19.5" D | 850 | 1,544 | 6 lbs. |
| 7540-ET-()  | 22" Wide End Table 22" W x 16.75" D | 897 | 1,126 | 55 lbs. |

OPTIONS

- PFW04 Premium Wood Finish, Table \$46
- VCT02 VCT Tile Glides (end table) \$14

All shipments for this series will be blanket-wrapped as standard. For customers located in Territory 1 who require cartoning, a 5% upcharge will be added to each product. Please contact client services for additional information.

SUITE GUEST + TANDEM | Designed by David Dahl

TANDEM CONFIGURATIONS & ORDERING EXAMPLES:



| Qty | Model # | Description | COM List |
|-----|-----------|---|----------|
| 2 | 7540-ET-W | 22" Wide End Table, Wood Top (\$897 List each) | \$1,794 |
| 1 | 7520-ST-W | Tandem Starter Unit, Wood Arm Caps | \$1,640 |
| 2 | 7520-AO-W | Tandem Add-On Unit, Wood Arm Caps (\$1,468 List each) | \$2,936 |
| 1 | 7520-EU-W | Tandem End Unit, Wood Arm Caps | \$1,451 |
| | | | \$7,821 |



| Qty | Model # | Description | COM List |
|-----|------------|--|----------|
| 1 | 7522-U | Tandem Two-Seater, Black Urethane Arm Caps | \$2,977 |
| 1 | 7540-15-SF | 15" Wide Inline Table, Solid Surface Top | \$851 |
| 1 | 7523-U | Tandem Three-Seater, Black Urethane Arm Caps | \$4,391 |
| | | | \$8,219 |

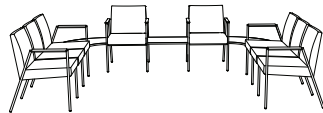



| Qty | Model # | Description | COM List |
|-----|-----------|---|----------|
| 2 | 7535-ST-W | Tandem Starter Unit, Wood Arm Cap/Armless (\$1,542 List each) | \$3,084 |
| 2 | 7530-AO | Tandem Add-On Unit, Armless (\$1,386 List each) | \$2,772 |
| 2 | 7535-EU-W | Tandem End Unit, Armless/Wood Arm Cap (\$1,448 List each) | \$2,896 |
| 2 | 7540-90-W | 90-Degree Connecting Table, Wood Top (\$850 List each) | \$1,700 |
| 2 | 7521-W | Single Chair, Wood Arm Caps (\$1,643 List each) | \$3,286 |
| 1 | 7540-22-W | 22" Wide Inline Table, Wood Top | \$787 |
| | | | \$14,525 |

All shipments for this series will be blanket-wrapped as standard. For customers located in Territory 1 who require cartoning, a 5% upcharge will be added to each product. Please contact client services for additional information.

SUITE GUEST + TANDEM | Designed by David Dahl

PRODUCT FEATURES:

- Concealed velcro attachment.
- Replacement seat and back covers can be easily field installed on previously ordered Suite models with replaceable cover option.
- Suite models originally ordered with standard fixed upholstery can utilize replacement seat and/or back covers; however, some upholstery work will be required to remove original upholstery covers.









| MODEL | PRODUCT SPECIFICATIONS | FABRIC GRADES | | | | | | | | | | LEATHER | |
|---|--|---------------|-----|-----|-----|-----|-----|----------|-----|-----|-----|---------|-----|
| | | COM | A | 1 | 2 | 3 | 4 | COL 5 | 6 | 7 | 8 | L1 | L2 |
| RSC-7515  | Replacement Upholstered Seat Cover COM: .75 yd. COL: 15 sq. ft. | 229 | 280 | 307 | 324 | 350 | 379 | 404 | 430 | 457 | 484 | 607 | 697 |
| | | | | | | | | | | | | | |
| RBC-7515  | Replacement Upholstered Back Cover COM: .75 yd. COL: 15 sq. ft. | 229 | 280 | 307 | 324 | 350 | 379 | 404 | 430 | 457 | 484 | 607 | 697 |
| | | | | | | | | | | | | | |

All shipments for this series will be blanket-wrapped as standard. For customers located in Territory 1 who require cartoning, a 5% upcharge will be added to each product. Please contact client services for additional information.

SUITE GUEST + TANDEM | Designed by David Dahl

PRODUCT FEATURES:

- Replacement hardware included with replacement arms and/or arm caps.
- Please specify frame finish and/or wood arm cap finish as applicable.

| MODEL | PRODUCT SPECIFICATIONS | LIST |
|---|---|------|
|  7500-AR (Right Arm, As Seated) | Replacement Arm, No Arm Cap Guest/Tandem Models Weight: 4 lbs. | 204 |
|  7500-AC (Center Arm, As Seated) | Replacement Arm, No Arm Cap Guest/Tandem Models Weight: 4 lbs. | 239 |
|  7500-AL (Left Arm, As Seated) | Replacement Arm, No Arm Cap Guest/Tandem Models Weight: 4 lbs. | 204 |
|  7505-AR (Right Side, As Seated) | Replacement Frame Armless Guest/Tandem Models Weight: 3 lbs. | 155 |
|  7505-AC (Center, As Seated) | Replacement Frame Armless Guest/Tandem Models Weight: 3 lbs. | 195 |
|  7505-AL (Left Side, As Seated) | Replacement Frame Armless Guest/Tandem Models Weight: 3 lbs. | 155 |
|  7507-U (Black Urethane) | Replacement Black Urethane Arm Cap Guest/Tandem Models Weight: .5 lb. | 59 |
|  7507-W (Wood) | Replacement Wood Arm Cap Guest/Tandem Models Weight: .5 lb. | 79 |
|  7507-SF (Solid Surface) | Replacement Solid Surface Arm Cap Guest/Tandem Models Weight: 1 lb. | 171 |

OPTIONS

-PFW01 Premium Wood Finish, Arm Cap (per arm cap) \$12

SUITE GUEST + TANDEM | Designed by David Dahl

UPHOLSTERY COMBINATIONS:

- For upholstery combinations, refer to the pricing below.
- When combining two COM/COV/COL fabrics, or fabrics with the same grade, add \$120 List per unit.
- When combining three or more COM/COV/COL fabrics, or fabrics with the same grade, add \$150 List per unit.
- When combining different grades of fabric, price will be based on the highest grade specified.
- Two-tone upholstery examples and yardage requirements for the most common combinations are listed below. Additional combinations available; please contact client services for yardage requirements and pricing.
- Note: Yardage amounts are based on fabric which is plain (i.e. non-directional) and a full 54" wide.
- Appropriate upholstery code must be included.



Code

Model

All Single Guest
and Tandem Units

SS1

COM Requirement

Back = .75 yd.
Balance of Chair = .75 yd.



Code

Model

All Single Guest
and Tandem Units

SS2

COM Requirement

Inside Back/Top of Seat = 1.25 yds.
Balance of Chair = .75 yd.

All shipments for this series will be blanket-wrapped as standard. For customers located in Territory 1 who require cartoning, a 5% upcharge will be added to each product. Please contact client services for additional information.

SUNNY GUEST | Designed by Rainlight



SPECIFICATIONS:

- Guest and settee models with wood frame.
- Wood frame manufactured in Ash and features die-cast aluminum connectors.
- Offered in all standard and custom wood finishes on Ash.
- For Alabaster and Super Matte Sable Ash, premium wood finish upcharge applies. Refer to options section for pricing.
- For custom wood finishes, please add \$531 List per color per order.
- Die-cast aluminum connectors available in standard and premium finishes. See below for options.
- For custom finish colors, please contact client services for pricing.
- Guest chair features 275 lb. weight capacity; settee features 325 lb. weight capacity.
- All dimensions are nominal.
- Refer to terms and conditions for general information regarding fabrics, finishes, warranty, freight, complete condition of sales and more.

STANDARD METAL CONNECTOR FINISH COLORS:

- 0405 Charcoal Grey
- 0535 Metallic Silver
- 0630 Satin Black

PREMIUM METAL CONNECTOR FINISH COLORS:



- 0605 Matte Black
- 0705 Matte Cotton
- 0788 Glossy Cotton
- 0805 Oasis
- 0905 Mint
- 1005 Mercury
- 1105 Canary
- 1205 Stone
- 1305 Sage
- 1405 Ice Blue
- 1505 Clay

All shipments for this series will be blanket-wrapped as standard. For customers located in Territory 1 who require cartoning, a 5% upcharge will be added to each product. Please contact client services for additional information.

SUNNY GUEST | Designed by Rainlight

ORDERING REQUIREMENTS:

- Model number
- Frame finish
- Aluminum connector finish
- Upholstery selection
- Options, as applicable

| MODEL | PRODUCT SPECIFICATIONS | FABRIC GRADES | | | | | | | | | | LEATHER | |
|---|---|---------------|-------|-------|-------|-------|-------|----------|-------|-------|-------|---------|-------|
| | | COM | A | 1 | 2 | 3 | 4 | COL 5 | 6 | 7 | 8 | L1 | L2 |
| 8310  | Guest Chair 20.5" W x 24.5" D x 30.5" H Seat: 20.5" W x 18" D Seat Ht: 18" COM: 1.25 yds. COL: 25 sq. ft. 17.5 lbs. | 1,809 | 1,894 | 1,939 | 1,967 | 2,011 | 2,058 | 2,101 | 2,144 | 2,188 | 2,233 | 2,439 | 2,589 |
| 8311  | Settee 40.25" W x 24.75" D x 30.25" H Seat: 40.25" W x 18.25" D Seat Ht: 18" COM: 2.25 yds. COL: 45 sq. ft. 35 lbs. | 2,091 | 2,244 | 2,325 | 2,375 | 2,454 | 2,539 | 2,616 | 2,694 | 2,773 | 2,854 | 3,225 | 3,495 |

OPTIONS

| | | |
|--------|-----------------------------------|------|
| -PFM01 | Premium Aluminum Connector Finish | \$71 |
| -PFW03 | Premium Wood Frame Finish | \$34 |
| -FG04 | Felt Glides | \$26 |
| -NS04 | Non-Skid Glides | \$26 |

SUNNY GUEST | Designed by Rainlight

UPHOLSTERY COMBINATIONS:

- For upholstery combinations, refer to the pricing below.
- When combining two COM/COV/COL fabrics, or fabrics with the same grade, add \$120 List per unit.
- When combining three or more COM/COV/COL fabrics, or fabrics with the same grade, add \$150 List per unit.
- When combining different grades of fabric, price will be based on the highest grade specified.
- Two-tone upholstery examples and yardage requirements for the most common combinations are listed below. Additional combinations available; please contact client services for yardage requirements and pricing.
- Note: Yardage amounts are based on fabric which is plain (i.e. non-directional) and a full 54" wide.
- Appropriate upholstery code must be included.



Code **SG1**
Model COM Requirement
8310 Seat = .75 yd.
 Back = .75 yd.



Code **SG2**
Model COM Requirement
8310 Outer Edge Band (Back & Seat) = .75 yd.
 Balance of Chair = 1 yd.



Code **SS1**
Model COM Requirement
8311 Seat = 1.25 yds.
 Back = 1.25 yds.



Code **SS2**
Model COM Requirement
8311 Outer Edge Band (Back & Seat) = 1 yd.
 Balance of Chair = 1.5 yds.

All shipments for this series will be blanket-wrapped as standard. For customers located in Territory 1 who require cartoning, a 5% upcharge will be added to each product. Please contact client services for additional information.

SUNNY KIDS | Designed by Rainlight

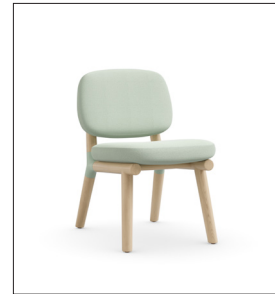

SPECIFICATIONS:

- Wood frame manufactured in Ash and features die-cast aluminum connectors.
- Offered in all standard and custom wood finishes on Ash.
- For Alabaster and Super Matte Sable Ash, premium wood finish upcharge applies. Refer to options section for pricing.
- For custom wood finishes, please add \$531 List per color per order.
- Die-cast aluminum connectors available in standard and premium finishes. See below for options.
- For custom finish colors, please contact client services for pricing.
- 275 lb. weight capacity.
- All dimensions are nominal.
- Refer to terms and conditions for general information regarding fabrics, finishes, warranty, freight, complete condition of sales and more.

STANDARD METAL CONNECTOR FINISH COLORS:

- 0405 Charcoal Grey
- 0535 Metallic Silver
- 0630 Satin Black

PREMIUM METAL CONNECTOR FINISH COLORS:

- 0605 Matte Black
- 0705 Matte Cotton
- 0788 Glossy Cotton
- 0805 Oasis
- 0905 Mint
- 1005 Mercury
- 1105 Canary
- 1205 Stone
- 1305 Sage
- 1405 Ice Blue
- 1505 Clay

All shipments for this series will be blanket-wrapped as standard. For customers located in Territory 1 who require cartoning, a 5% upcharge will be added to each product. Please contact client services for additional information.

SUNNY KIDS | Designed by Rainlight

ORDERING REQUIREMENTS:

- Model number
- Frame finish
- Aluminum connector finish
- Upholstery selection
- Options, as applicable

| MODEL | PRODUCT SPECIFICATIONS | FABRIC GRADES | | | | | | | | | | LEATHER | |
|--|---|---------------|-------|-------|-------|-------|-------|----------|-------|-------|-------|---------|-------|
| | | COM | A | 1 | 2 | 3 | 4 | COL 5 | 6 | 7 | 8 | L1 | L2 |
| 8315  | Kids Guest Chair 18" W x 23.5" D x 26.5" H Seat: 18" W x 17" D Seat Ht: 15.75" COM: 1 yd. COL: 20 sq. ft. 17 lbs. | 1,572 | 1,640 | 1,676 | 1,698 | 1,733 | 1,771 | 1,805 | 1,840 | 1,875 | 1,911 | 2,076 | 2,196 |

OPTIONS

| | | |
|--------|-----------------------------------|------|
| -PFM01 | Premium Aluminum Connector Finish | \$71 |
| -PFW03 | Premium Wood Frame Finish | \$34 |
| -FG04 | Felt Glides | \$26 |
| -NS04 | Non-Skid Glides | \$26 |

SUNNY KIDS | Designed by Rainlight

UPHOLSTERY COMBINATIONS:

- For upholstery combinations, refer to the pricing below.
- When combining two COM/COV/COL fabrics, or fabrics with the same grade, add \$120 List per unit.
- When combining three or more COM/COV/COL fabrics, or fabrics with the same grade, add \$150 List per unit.
- When combining different grades of fabric, price will be based on the highest grade specified.
- Two-tone upholstery examples and yardage requirements for the most common combinations are listed below. Additional combinations available; please contact client services for yardage requirements and pricing.
- Note: Yardage amounts are based on fabric which is plain (i.e. non-directional) and a full 54" wide.
- Appropriate upholstery code must be included.



| Code | SK1 |
|--------------|----------------------------------|
| <u>Model</u> | <u>COM Requirement</u> |
| 8315 | Seat = .75 yd. Back = .75 yd. |



| Code | SK2 |
|--------------|--|
| <u>Model</u> | <u>COM Requirement</u> |
| 8315 | Outer Edge Band (Back & Seat) = .5 yd. Balance of Chair = .75 yd. |

All shipments for this series will be blanket-wrapped as standard. For customers located in Territory 1 who require cartoning, a 5% upcharge will be added to each product. Please contact client services for additional information.

SUNNY LOUNGE | Designed by Rainlight



SPECIFICATIONS:

- Wood frame manufactured in Ash and features die-cast aluminum connectors.
- Offered in all standard and custom wood finishes on Ash.
- For Alabaster and Super Matte Sable Ash, premium wood finish upcharge applies. Refer to options section for pricing.
- For custom wood finishes, please add \$531 List per color per order.
- Die-cast aluminum connectors available in standard and premium finishes. See below for options.
- For custom finish colors, please contact client services for pricing.
- 275 lb. weight capacity.
- All dimensions are nominal.
- Refer to terms and conditions for general information regarding fabrics, finishes, warranty, freight, complete condition of sales and more.

STANDARD METAL CONNECTOR FINISH COLORS:

- 0405 Charcoal Grey
- 0535 Metallic Silver
- 0630 Satin Black

PREMIUM METAL CONNECTOR FINISH COLORS:

- 0605 Matte Black
- 0705 Matte Cotton
- 0788 Glossy Cotton
- 0805 Oasis
- 0905 Mint
- 1005 Mercury
- 1105 Canary
- 1205 Stone
- 1305 Sage
- 1405 Ice Blue
- 1505 Clay

All shipments for this series will be blanket-wrapped as standard. For customers located in Territory 1 who require cartoning, a 5% upcharge will be added to each product. Please contact client services for additional information.

SUNNY LOUNGE | Designed by Rainlight

ORDERING REQUIREMENTS:

- Model number
- Frame finish
- Aluminum connector finish
- Upholstery selection
- Options, as applicable

| MODEL | PRODUCT SPECIFICATIONS | FABRIC GRADES | | | | | | | | | | LEATHER | |
|--|---|---------------|-------|-------|-------|-------|-------|----------|-------|-------|-------|---------|-------|
| | | COM | A | 1 | 2 | 3 | 4 | COL 5 | 6 | 7 | 8 | L1 | L2 |
| 8320  | Lounge Chair 21.75" W x 25.75" D x 27.5" H Seat: 21.75" W x 20.5" D Seat Ht: 16.25" COM: 1.5 yds. COL: 30 sq. ft. 19.5 lbs. | 1,942 | 2,044 | 2,098 | 2,131 | 2,184 | 2,241 | 2,292 | 2,344 | 2,397 | 2,451 | 2,698 | 2,878 |

OPTIONS

| | | |
|--------|-----------------------------------|------|
| -PFM01 | Premium Aluminum Connector Finish | \$71 |
| -PFW03 | Premium Wood Frame Finish | \$34 |
| -FG04 | Felt Glides | \$26 |
| -NS04 | Non-Skid Glides | \$26 |

SUNNY LOUNGE | Designed by Rainlight

UPHOLSTERY COMBINATIONS:

- For upholstery combinations, refer to the pricing below.
- When combining two COM/COV/COL fabrics, or fabrics with the same grade, add \$120 List per unit.
- When combining three or more COM/COV/COL fabrics, or fabrics with the same grade, add \$150 List per unit.
- When combining different grades of fabric, price will be based on the highest grade specified.
- Two-tone upholstery examples and yardage requirements for the most common combinations are listed below. Additional combinations available; please contact client services for yardage requirements and pricing.
- Note: Yardage amounts are based on fabric which is plain (i.e. non-directional) and a full 54" wide.
- Appropriate upholstery code must be included.



| Code | SL1 |
|--------------|--------------------------------|
| <u>Model</u> | <u>COM Requirement</u> |
| 8320 | Seat = 1 yd. Back = .75 yd. |



| Code | SL2 |
|--------------|---|
| <u>Model</u> | <u>COM Requirement</u> |
| 8320 | Outer Edge Band (Back & Seat) = .75 yd. Balance of Chair = 1 yd. |

All shipments for this series will be blanket-wrapped as standard. For customers located in Territory 1 who require cartoning, a 5% upcharge will be added to each product. Please contact client services for additional information.

SUNNY OCCASIONAL TABLES | Designed by Rainlight



SPECIFICATIONS:

- Round and oval top shapes.
- Two heights: 16" and 18".
- Four top surface options: wood veneer, laminate, Fenix® and solid surface.
- Wood veneer tops and wood base available in all standard and custom finishes on Ash.
- For Alabaster and Super Matte Sable Ash finish, premium wood finish upcharge applies. Refer to option section for pricing.
- For custom wood finishes, please contact client services and add one-time upcharge of \$531 List per color per order.
- For custom laminate options, add \$649 List per color per order. Pre-approval required, please contact client services.
- Fenix offered in five standard colorways.
- For non-standard Fenix colors, please contact client services for pricing.
- For veneer, standard wood grain and solid black laminate, as well as Fenix Nero Ingo (black), edge will match top finish color, unless specified otherwise.
- For all other solid color laminate and Fenix tops, edge to match specified leg finish.
- Solid surface available in white only with exposed plywood clear coat edge.
- Die-cast aluminum connectors available in standard and premium finishes. See below for options
- For custom finish colors, please contact client services for pricing.
- All dimensions are nominal.
- Refer to terms and conditions for general information regarding finishes, warranty, freight, complete condition of sales and more.

EDGE DETAIL:

Laminate*/Veneer/Fenix Top



Solid Surface Top



*Please note that laminate thickness is nominal and may vary.

STANDARD METAL CONNECTOR FINISH COLORS:

- 0405 Charcoal Grey
- 0535 Metallic Silver
- 0630 Satin Black

PREMIUM METAL CONNECTOR FINISH COLORS:



- 0605 Matte Black
- 0705 Matte Cotton
- 0788 Glossy Cotton
- 0805 Oasis
- 0905 Mint
- 1005 Mercury
- 1105 Canary
- 1205 Stone
- 1305 Sage
- 1405 Ice Blue
- 1505 Clay

All shipments for this series will be blanket-wrapped as standard. For customers located in Territory 1 who require cartoning, a 5% upcharge will be added to each product. Please contact client services for additional information.

SUNNY OCCASIONAL TABLES | Designed by Rainlight

ORDERING REQUIREMENTS:

- Model number
- Top surface material
- Top finish, if applicable
- Base finish
- Aluminum connector finish
- Options, as applicable

| | MODEL | DIMENSIONS | VENEER TOP (-V) LAMINATE TOP (-L) | FENIX TOP (-FE) | SOLID SURFACE TOP (-SF) | WEIGHT |
|---|--------------------|-----------------------|--------------------------------------|-----------------|----------------------------|-----------|
|  | Round Table | | | | | |
| | 8300-2018-() | 20" Dia x 18" H | 1,375 | 1,503 | 1,630 | 13.5 lbs. |
| | 8300-3016-() | 30" Dia x 16" H | 1,664 | 1,952 | 2,358 | 18.5 lbs. |
| | 8300-3616-() | 36" Dia x 16" H | 1,919 | 2,334 | 2,918 | 21.5 lbs. |
|  | Oval Table | | | | | |
| | 8300-482216-() | 48" W x 22" D x 16" H | 1,988 | 2,326 | 2,802 | 23.5 lbs. |

OPTIONS

| | | |
|--------|-----------------------------------|------|
| -PFM01 | Premium Aluminum Connector Finish | \$71 |
| -PFW04 | Premium Wood Finish | \$46 |
| -FG04 | Felt Glides | \$26 |
| -NS04 | Non-Skid Glides | \$26 |

All shipments for this series will be blanket-wrapped as standard. For customers located in Territory 1 who require cartoning, a 5% upcharge will be added to each product. Please contact client services for additional information.

TROVE NESTING | Designed by 5d Studio



SPECIFICATIONS:

- Guest chair collection with passive nesting capability (no lifting of seat required).
- To nest, simply push chairs together.
- Glass-filled nylon shell with optional upholstered seat and back pads.
- Shell available in 3 colors. Please refer to listing below.
- Three base options: 4-leg metal with casters, 4-leg metal with glides and 4-leg wood with glides.
- 4-leg metal bases offered in standard and premium metal finishes. Please refer to listing below.
- Poly tread casters provide universal flooring applicability, whether hard-surface or carpet, and are available in white, black and charcoal grey, please specify.
- Glides on 4-leg metal models available in black only.
- 4-leg wood base offered in all standard finishes on Beech and features metal trim.
- For Super Matte Sable Beech, premium wood finish upcharge applies. Refer to options section for pricing.
- For custom wood finish colors, please contact client services for pricing.
- Metal trim on wood leg models offered in standard and premium metal finishes. Please refer to listing below.
- If cartoning is required, chairs are packaged in units of three (3). A \$20 List carton break charge will be applied for orders with only one or two chairs.
- Maximum weight capacity: 300 lbs. for wood 4-leg models and 400 lbs. for metal 4-leg models.
- All dimensions are nominal.
- Refer to terms and conditions for general information regarding fabrics, finishes, warranty, freight, complete condition of sales and more.

SHELL COLORS:

- 136 Studio White
- 137 Simply Black
- 138 Charcoal

CASTER COLORS:

- White
- Black
- Charcoal

STANDARD METAL BASE AND TRIM FINISH COLORS:

- 0405 Charcoal Grey
- 0630 Satin Black
- 0705 Matte Cotton

PREMIUM METAL BASE AND TRIM FINISH COLORS:

- 0535 Metallic Silver
- 0605 Matte Black
- 0788 Glossy Cotton
- 0805 Oasis
- 0905 Mint
- 1005 Mercury
- 1105 Canary
- 1205 Stone
- 1305 Sage
- 1405 Ice Blue
- 1505 Clay

All shipments for this series will be blanket-wrapped as standard. For customers located in Territory 1 who require cartoning, a 5% upcharge will be added to each product. Please contact client services for additional information.

TROVE NESTING | Designed by 5d Studio

NESTING DIMENSIONS:

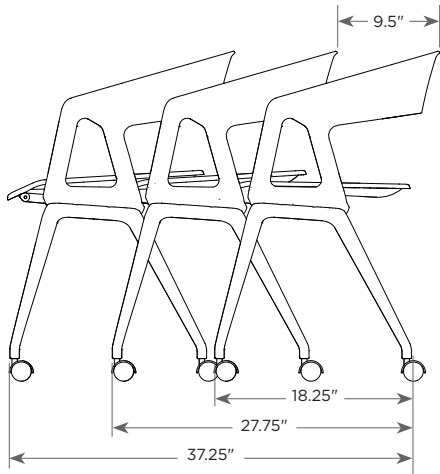



*Dimensions are nominal and based on the average distance between nested chairs.

All shipments for this series will be blanket-wrapped as standard. For customers located in Territory 1 who require cartoning, a 5% upcharge will be added to each product. Please contact client services for additional information.

TROVE NESTING | Designed by 5d Studio

ORDERING REQUIREMENTS:

- Model number
- Shell color
- Base finish
- Caster color
- Upholstery selection, as applicable
- Options, as applicable

| MODEL | PRODUCT SPECIFICATIONS | FABRIC GRADES | | | | | | | | LEATHER | | | |
|--|---|---------------|-----|-----|-----|-----|-------|----------|-------|---------|-------|-------|-------|
| | | COM | A | 1 | 2 | 3 | 4 | COL 5 | 6 | 7 | 8 | L1 | L2 |
| 9701  | Nylon Shell, 4-Leg Metal Base, Casters 23.5" W x 21.5" D x 30" H Seat: 18" W x 18.5" D Seat Ht: 17.5" 21 lbs. | 613 | | | | | | | | | | | |
| 9701-US  | Nylon Shell with Upholstered Seat Pad, 4-Leg Metal Base, Casters 23.5" W x 21.75" D x 30" H Seat: 18" W x 18.75" D Seat Ht: 18.75" COM: .75 yd. COL: 15 sq. ft. 22 lbs. | 691 | 742 | 769 | 786 | 812 | 841 | 866 | 892 | 919 | 946 | 1,069 | 1,159 |
| 9701-US-UB  | Nylon Shell with Upholstered Seat and Back Pads, 4-Leg Metal Base, Casters 23.5" W x 21.75" D x 30" H Seat: 18" W x 18.75" D Seat Ht: 18.75" COM: 1.25 yds. COL: 25 sq. ft. 23 lbs. | 770 | 855 | 900 | 928 | 972 | 1,019 | 1,062 | 1,105 | 1,149 | 1,194 | 1,400 | 1,550 |

OPTIONS



| | | |
|--------|------------------------------------|-------|
| -PFM02 | Premium Metal Base Finish | \$101 |
| -GD00 | Glides (black finish only) | n/c |
| -NS04 | Non-Skid Glides (for -GD00 option) | \$26 |

All shipments for this series will be blanket-wrapped as standard. For customers located in Territory 1 who require cartoning, a 5% upcharge will be added to each product. Please contact client services for additional information.

TROVE NESTING | Designed by 5d Studio

ORDERING REQUIREMENTS:

- Model number
- Shell color
- Wood base finish
- Trim finish
- Upholstery selection, as applicable
- Options, as applicable

| MODEL | PRODUCT SPECIFICATIONS | FABRIC GRADES | | | | | | | | LEATHER | | | |
|--|---|---------------|-------|-------|-------|-------|-------|----------|-------|---------|-------|-------|-------|
| | | COM | A | 1 | 2 | 3 | 4 | COL 5 | 6 | 7 | 8 | L1 | L2 |
| 9702  | Nylon Shell, 4-Leg Wood Base, Glides 23.5" W x 21.5" D x 30" H Seat: 18" W x 18.5" D Seat Ht: 17.5" 21 lbs. | 823 | | | | | | | | | | | |
| 9702-US  | Nylon Shell with Upholstered Seat Pad, 4-Leg Wood Base, Glides 23.5" W x 21.75" D x 30" H Seat: 18" W x 18.75" D Seat Ht: 18.75" COM: .75 yd. COL: 15 sq. ft. 22 lbs. | 901 | 952 | 979 | 996 | 1,022 | 1,051 | 1,076 | 1,102 | 1,129 | 1,156 | 1,279 | 1,369 |
| 9702-US-UB  | Nylon Shell with Upholstered Seat and Back Pads, 4-Leg Wood Base, Glides 23.5" W x 21.75" D x 30" H Seat: 18" W x 18.75" D Seat Ht: 18.75" COM: 1.25 yds. COL: 25 sq. ft. 23 lbs. | 980 | 1,065 | 1,110 | 1,138 | 1,182 | 1,229 | 1,272 | 1,315 | 1,359 | 1,404 | 1,610 | 1,760 |

OPTIONS

| | | |
|--------|---------------------------|-------|
| -PFW02 | Premium Wood Base Finish | \$23 |
| -LT01 | Premium Metal Trim Finish | \$119 |
| -NS04 | Non-Skid Glides | \$26 |

All shipments for this series will be blanket-wrapped as standard. For customers located in Territory 1 who require cartoning, a 5% upcharge will be added to each product. Please contact client services for additional information.

TROVE NESTING | Designed by 5d Studio

UPHOLSTERY COMBINATIONS:

- For upholstery combinations, refer to the pricing below.
- When combining two COM/COV/COL fabrics, or fabrics with the same grade, add \$120 List per unit.
- When combining three or more COM/COV/COL fabrics, or fabrics with the same grade, add \$150 List per unit.
- When combining different grades of fabric, price will be based on the highest grade specified.
- Two-tone upholstery examples and yardage requirements for the most common combinations are listed below. Additional combinations available; please contact client services for yardage requirements and pricing.
- Note: Yardage amounts are based on fabric which is plain (i.e. non-directional) and a full 54" wide.
- Appropriate upholstery code must be included.



Code

Model

9701-US-UB

9702-US-UB

TV1

COM Requirement

Seat Pad = .75 yd.

Back Pad = .75 yd.

All shipments for this series will be blanket-wrapped as standard. For customers located in Territory 1 who require cartoning, a 5% upcharge will be added to each product. Please contact client services for additional information.

TROVE SWIVEL | Designed by 5d Studio



SPECIFICATIONS:

- Glass-filled nylon shell with optional upholstered seat and back pads.
- Shell available in 3 colors. Please refer to listing below.
- Two swivel base options: 4-prong with glides and 5-prong with casters.
- 4-prong swivel base models feature auto-return and are available with polished aluminum base finish as standard.
- 5-prong base models feature height adjustability and swivel properties, with rocker/tilt or non-tilting mechanisms and black nylon base as standard. Polished aluminum base also available. Please specify (-AB02) after model number and refer to listed pricing.
- Premium finishes also available on both base options. Please refer to listing below.
- Poly tread casters provide universal flooring applicability, whether hard-surface or carpet, and are available in white, black and charcoal grey, please specify.
- 400 lb. weight capacity.
- All dimensions are nominal.
- Refer to terms and conditions for general information regarding fabrics, finishes, warranty, freight, complete condition of sales and more.

SHELL COLORS:

- 136 Studio White
- 137 Simply Black
- 138 Charcoal

CASTER COLORS:

- White
- Black
- Charcoal

PREMIUM BASE FINISH COLORS:



- 0405 Charcoal Grey
- 0535 Metallic Silver
- 0605 Matte Black
- 0630 Satin Black
- 0705 Matte Cotton
- 0788 Glossy Cotton
- 0805 Oasis
- 0905 Mint
- 1005 Mercury
- 1105 Canary
- 1205 Stone
- 1305 Sage
- 1405 Ice Blue
- 1505 Clay

All shipments for this series will be blanket-wrapped as standard. For customers located in Territory 1 who require cartoning, a 5% upcharge will be added to each product. Please contact client services for additional information.

TROVE SWIVEL | Designed by 5d Studio

ORDERING REQUIREMENTS:

- Model number
- Shell color
- Base finish
- Upholstery selection, as applicable
- Options, as applicable

| MODEL | PRODUCT SPECIFICATIONS | FABRIC GRADES | | | | | | | | LEATHER | | | |
|--|--|---------------|-------|-------|-------|-------|-------|----------|-------|---------|-------|-------|-------|
| | | COM | A | 1 | 2 | 3 | 4 | COL 5 | 6 | 7 | 8 | L1 | L2 |
| 9703  | Nylon Shell, 4-Prong Metal Swivel Base with Auto-Return, Glides 23.5" W x 21.5" D x 30" H Seat: 18" W x 18.5" D Seat Ht: 17.5" 21 lbs. | 1,042 | | | | | | | | | | | |
| 9703-US  | Nylon Shell with Upholstered Seat Pad, 4-Prong Metal Swivel Base with Auto-Return, Glides 23.5" W x 21.75" D x 30" H Seat: 18" W x 18.75" D Seat Ht: 18.75" COM: .75 yd. COL: 15 sq. ft. 22 lbs. | 1,121 | 1,172 | 1,199 | 1,216 | 1,242 | 1,271 | 1,296 | 1,322 | 1,349 | 1,376 | 1,499 | 1,589 |
| 9703-US-UB  | Nylon Shell with Upholstered Seat and Back Pads, 4-Prong Metal Swivel Base with Auto-Return, Glides 23.5" W x 21.75" D x 30" H Seat: 18" W x 18.75" D Seat Ht: 18.75" COM: 1.25 yds. COL: 25 sq. ft. 23 lbs. | 1,200 | 1,285 | 1,330 | 1,358 | 1,402 | 1,449 | 1,492 | 1,535 | 1,579 | 1,624 | 1,830 | 1,980 |

OPTIONS



- PFM02 Premium Metal Base Finish \$101
- NS04 Non-Skid Glides \$26

All shipments for this series will be blanket-wrapped as standard. For customers located in Territory 1 who require cartoning, a 5% upcharge will be added to each product. Please contact client services for additional information.

TROVE SWIVEL | Designed by 5d Studio

ORDERING REQUIREMENTS:

- Model number
- Shell color
- Base finish
- Upholstery selection, as applicable
- Options, as applicable

| MODEL | PRODUCT SPECIFICATIONS | BASE FINISH | FABRIC GRADES | | | | | | | | LEATHER | | | |
|--|---|---------------------------|---------------|-------|-------|-------|-------|-------|----------|-------|---------|-------|-------|-------|
| | | | COM | A | 1 | 2 | 3 | 4 | COL 5 | 6 | 7 | 8 | L1 | L2 |
| 9704  | Nylon Shell, 5-Prong Base, Casters, Non-Tilt, Height Adjustable Swivel Mechanism 23.5" W x 21.5" D x 30" H Seat: 18" W x 18.5" D Seat Ht: 17.5" 22 lbs. | Black Nylon | 981 | | | | | | | | | | | |
| | | Polished Aluminum (-AB02) | 1,168 | | | | | | | | | | | |
| 9704-US  | Nylon Shell with Upholstered Seat Pad, 5-Prong Base, Casters, Non-Tilt, Height Adjustable Swivel Mechanism 23.5" W x 21.75" D x 30" H Seat: 18" W x 18.75" D Seat Ht: 18.75" COM: .75 yd. COL: 15 sq. ft. 23 lbs. | Black Nylon | 1,060 | 1,111 | 1,138 | 1,155 | 1,181 | 1,210 | 1,235 | 1,261 | 1,288 | 1,315 | 1,438 | 1,528 |
| | | Polished Aluminum (-AB02) | 1,247 | 1,298 | 1,325 | 1,342 | 1,368 | 1,397 | 1,422 | 1,448 | 1,475 | 1,502 | 1,625 | 1,715 |
| 9704-US-UB  | Nylon Shell with Upholstered Seat and Back Pads, 5-Prong Base, Casters, Non-Tilt, Height Adjustable Swivel Mechanism 23.5" W x 21.75" D x 30" H Seat: 18" W x 18.75" D Seat Ht: 18.75" COM: 1.25 yds. COL: 25 sq. ft. 24 lbs. | Black Nylon | 1,139 | 1,224 | 1,269 | 1,297 | 1,341 | 1,388 | 1,431 | 1,474 | 1,518 | 1,563 | 1,769 | 1,919 |
| | | Polished Aluminum (-AB02) | 1,326 | 1,411 | 1,456 | 1,484 | 1,528 | 1,575 | 1,618 | 1,661 | 1,705 | 1,750 | 1,956 | 2,106 |

OPTIONS

- PFM02 Premium Metal Base Finish \$101
(apply to polished aluminum base price)
- SK01 Stool Kit* \$120



*Stool kit reduces weight capacity to 275 lbs.

All shipments for this series will be blanket-wrapped as standard. For customers located in Territory 1 who require cartoning, a 5% upcharge will be added to each product. Please contact client services for additional information.

TROVE SWIVEL | Designed by 5d Studio

ORDERING REQUIREMENTS:

- Model number
- Shell color
- Base finish
- Upholstery selection, as applicable
- Options, as applicable

| MODEL | PRODUCT SPECIFICATIONS | BASE FINISH | FABRIC GRADES | | | | | | | | LEATHER | | | |
|---|--|---------------------------|---------------|-------|-------|-------|-------|-------|----------|-------|---------|-------|-------|-------|
| | | | COM | A | 1 | 2 | 3 | 4 | COL 5 | 6 | 7 | 8 | L1 | L2 |
| 9704-RM01  | Nylon Shell, 5-Prong Base, Casters, Height Adjustable Swivel Mechanism with Rocker/Tilt Feature 23.5" W x 21.5" D x 30" H Seat: 18" W x 18.5" D Seat Ht: 17.5" 24 lbs. | Black Nylon | 1,075 | | | | | | | | | | | |
| | | Polished Aluminum (-AB02) | 1,262 | | | | | | | | | | | |
| 9704-US-RM01  | Nylon Shell with Upholstered Seat Pad, 5-Prong Base, Casters, Height Adjustable Swivel Mechanism with Rocker/Tilt Feature 23.5" W x 21.75" D x 30" H Seat: 18" W x 18.75" D Seat Ht: 18.75" COM: .75 yd. COL: 15 sq. ft. 25 lbs. | Black Nylon | 1,154 | 1,205 | 1,232 | 1,249 | 1,275 | 1,304 | 1,329 | 1,355 | 1,382 | 1,409 | 1,532 | 1,622 |
| | | Polished Aluminum (-AB02) | 1,341 | 1,392 | 1,419 | 1,436 | 1,462 | 1,491 | 1,516 | 1,542 | 1,569 | 1,596 | 1,719 | 1,809 |
| 9704-US-UB-RM01  | Nylon Shell with Upholstered Seat and Back Pads, 5-Prong Base, Casters, Height Adjustable Swivel Mechanism with Rocker/Tilt Feature 23.5" W x 21.75" D x 30" H Seat: 18" W x 18.75" D Seat Ht: 18.75" COM: 1.25 yds. COL: 25 sq. ft. 26 lbs. | Black Nylon | 1,233 | 1,318 | 1,363 | 1,391 | 1,435 | 1,482 | 1,525 | 1,568 | 1,612 | 1,657 | 1,863 | 2,013 |
| | | Polished Aluminum (-AB02) | 1,420 | 1,505 | 1,550 | 1,578 | 1,622 | 1,669 | 1,712 | 1,755 | 1,799 | 1,844 | 2,050 | 2,200 |

OPTIONS

-PFM02 Premium Metal Base Finish \$101
(apply to polished aluminum base price)

All shipments for this series will be blanket-wrapped as standard. For customers located in Territory 1 who require cartoning, a 5% upcharge will be added to each product. Please contact client services for additional information.

TROVE SWIVEL | Designed by 5d Studio

UPHOLSTERY COMBINATIONS:

- For upholstery combinations, refer to the pricing below.
- When combining two COM/COV/COL fabrics, or fabrics with the same grade, add \$120 List per unit.
- When combining three or more COM/COV/COL fabrics, or fabrics with the same grade, add \$150 List per unit.
- When combining different grades of fabric, price will be based on the highest grade specified.
- Two-tone upholstery examples and yardage requirements for the most common combinations are listed below. Additional combinations available; please contact client services for yardage requirements and pricing.
- Note: Yardage amounts are based on fabric which is plain (i.e. non-directional) and a full 54" wide.
- Appropriate upholstery code must be included.



| Code | TV1 |
|-----------------|------------------------|
| <u>Model</u> | <u>COM Requirement</u> |
| 9703-US-UB | Seat Pad = .75 yd. |
| 9704-US-UB | Back Pad = .75 yd. |
| 9704-US-UB-RM01 | |

TWIRL® GUEST | Designed by Chris & Jon Panichella



SPECIFICATIONS:

- Fully upholstered and wood back shell models available.
- Wood back shell models feature upholstered back cushion and fully upholstered seat.
- Wood back shell models feature exposed plywood edge.
- Edge finish on wood back shell models will match veneer finish as standard.
- Four base options: 4-leg metal, metal swivel, 4-leg wood and wood swivel.
- Swivel base models feature self-return.
- Metal bases available in standard and premium finishes.
- For custom metal finish colors, please contact client services for pricing.
- Wood offered in all standard and custom finishes on Ash.
- For Alabaster and Super Matte Sable Ash, premium wood finish upcharge applies. Refer to options section for pricing.
- For custom wood finishes, please contact client services and add one-time upcharge of \$531 List per color per order.
- 300 lb. weight capacity.
- All dimensions are nominal.
- Refer to terms and conditions for general information regarding fabrics, finishes, warranty, freight, complete condition of sales and more.

STANDARD METAL BASE FINISH COLORS:

- 0405 Charcoal Grey
- 0535 Metallic Silver
- 0199 Chrome (4-leg base only)
- 0299 Polished Aluminum (swivel base only)
- 0630 Satin Black

PREMIUM METAL BASE FINISH COLORS:





- 0605 Matte Black
- 0705 Matte Cotton
- 0788 Glossy Cotton
- 0805 Oasis
- 0905 Mint
- 1005 Mercury
- 1105 Canary
- 1205 Stone
- 1305 Sage
- 1405 Ice Blue
- 1505 Clay

All shipments for this series will be blanket-wrapped as standard. For customers located in Territory 1 who require cartoning, a 5% upcharge will be added to each product. Please contact client services for additional information.

TWIRL® GUEST | Designed by Chris & Jon Panichella

ORDERING REQUIREMENTS:

- Model number
- Wood back finish
- Base finish
- Upholstery selection
- Options, as applicable

| MODEL | PRODUCT SPECIFICATIONS | FABRIC GRADES | | | | | | | | | | LEATHER | |
|---|--|---------------|-------|-------|-------|-------|-------|----------|-------|-------|-------|---------|-------|
| | | COM | A | 1 | 2 | 3 | 4 | COL 5 | 6 | 7 | 8 | L1 | L2 |
| 60121-W  | Guest Chair, 4-Leg Metal Base Wood Back with Upholstered Cushion 24.5" W x 23.5" D x 30" H Seat: 18" W x 18" D Seat Ht: 19" COM: 2 yds. COL: 40 sq. ft. 23 lbs. | 1,617 | 1,753 | 1,825 | 1,869 | 1,939 | 2,015 | 2,083 | 2,153 | 2,223 | 2,295 | 2,625 | 2,865 |
| 60123-W  | Guest Chair, Metal Swivel Base Wood Back with Upholstered Cushion 23.5" W x 23" D x 29.5" H Seat: 18" W x 18" D Seat Ht: 18.5" COM: 2 yds. COL: 40 sq. ft. 25 lbs. | 1,771 | 1,907 | 1,979 | 2,023 | 2,093 | 2,169 | 2,237 | 2,307 | 2,377 | 2,449 | 2,779 | 3,019 |
| 60124-W  | Guest Chair, 4-Leg Wood Base Wood Back with Upholstered Cushion 23.5" W x 25" D x 29.5" H Seat: 18" W x 18" D Seat Ht: 18.5" COM: 2 yds. COL: 40 sq. ft. 24 lbs. | 1,634 | 1,770 | 1,842 | 1,886 | 1,956 | 2,032 | 2,100 | 2,170 | 2,240 | 2,312 | 2,642 | 2,882 |
| 60127-W  | Guest Chair, Wood Swivel Base Wood Back with Upholstered Cushion 23.5" W x 24" D x 29.5" H Seat: 18" W x 18" D Seat Ht: 18.5" COM: 2 yds. COL: 40 sq. ft. 27 lbs. | 1,970 | 2,106 | 2,178 | 2,222 | 2,292 | 2,368 | 2,436 | 2,506 | 2,576 | 2,648 | 2,978 | 3,218 |

OPTIONS

| | | |
|--------|---|-------|
| -PFM02 | Premium Metal Base Finish | \$101 |
| -PFW03 | Premium Wood Finish (wood back only) | \$34 |
| -PFW04 | Premium Wood Finish (wood back and base) | \$46 |
| -NSO4 | Non-Skid Glides (4-leg models only) | \$26 |
| -NSO4 | Non-Skid Glides (swivel base models only) | \$26 |
| -CO2 | Casters (metal swivel base models only)* | \$70 |





*Caster models feature 5-star base with swivel mechanism. Please apply upcharge to corresponding metal swivel base List price.

All shipments for this series will be blanket-wrapped as standard. For customers located in Territory 1 who require cartoning, a 5% upcharge will be added to each product. Please contact client services for additional information.

TWIRL® GUEST | Designed by Chris & Jon Panichella

ORDERING REQUIREMENTS:

- Model number
- Base finish
- Upholstery selection
- Options, as applicable

| MODEL | PRODUCT SPECIFICATIONS | FABRIC GRADES | | | | | | | | | | LEATHER | |
|---|---|---------------|-------|-------|-------|-------|-------|----------|-------|-------|-------|---------|-------|
| | | COM | A | 1 | 2 | 3 | 4 | COL 5 | 6 | 7 | 8 | L1 | L2 |
| 60121-U  | Guest Chair, 4-Leg Metal Base Fully Upholstered 25" W x 24" D x 30.5" H Seat: 18" W x 18" D Seat Ht: 19" COM: 2.25 yds. COL: 45 sq. ft. 25 lbs. | 1,638 | 1,791 | 1,872 | 1,922 | 2,001 | 2,086 | 2,163 | 2,241 | 2,320 | 2,401 | 2,772 | 3,042 |
| 60123-U  | Guest Chair, Metal Swivel Base Fully Upholstered 24" W x 23.5" D x 30" H Seat: 18" W x 18" D Seat Ht: 18.5" COM: 2.25 yds. COL: 45 sq. ft. 27 lbs. | 1,789 | 1,942 | 2,023 | 2,073 | 2,152 | 2,237 | 2,314 | 2,392 | 2,471 | 2,552 | 2,923 | 3,193 |
| 60124-U  | Guest Chair, 4-Leg Wood Base Fully Upholstered 24" W x 25.5" D x 30" H Seat: 18" W x 18" D Seat Ht: 18.5" COM: 2.25 yds. COL: 45 sq. ft. 26 lbs. | 1,635 | 1,788 | 1,869 | 1,919 | 1,998 | 2,083 | 2,160 | 2,238 | 2,317 | 2,398 | 2,769 | 3,039 |
| 60127-U  | Guest Chair, Wood Swivel Base Fully Upholstered 24" W x 24.5" D x 30" H Seat: 18" W x 18" D Seat Ht: 18.5" COM: 2.25 yds. COL: 45 sq. ft. 29 lbs. | 1,982 | 2,135 | 2,216 | 2,266 | 2,345 | 2,430 | 2,507 | 2,585 | 2,664 | 2,745 | 3,116 | 3,386 |

OPTIONS

| | | |
|--------|---|-------|
| -PFM02 | Premium Metal Base Finish | \$101 |
| -PFW02 | Premium Wood Finish | \$23 |
| -NSO4 | Non-Skid Glides (4-leg models only) | \$26 |
| -NSO4 | Non-Skid Glides (swivel base models only) | \$26 |
| -CO2 | Casters (metal swivel base models only)* | \$70 |

*Caster models feature 5-star base with swivel mechanism. Please apply upcharge to corresponding metal swivel base List price.

TWIRL® GUEST | Designed by Chris & Jon Panichella

UPHOLSTERY COMBINATIONS:

- For upholstery combinations, refer to the pricing below.
- When combining two COM/COV/COL fabrics, or fabrics with the same grade, add \$120 List per unit.
- When combining three or more COM/COV/COL fabrics, or fabrics with the same grade, add \$150 List per unit.
- When combining different grades of fabric, price will be based on the highest grade specified.
- Two-tone upholstery examples and yardage requirements for the most common combinations are listed below. Additional combinations available; please contact client services for yardage requirements and pricing.
- Note: Yardage amounts are based on fabric which is plain (i.e. non-directional) and a full 54" wide.
- Appropriate upholstery code must be included.



Code

Model

60121-U
60123-U
60124-U
60127-U

TW1

COM Requirement

Back Shell = 1.75 yds.
Balance of Chair = 1.25 yds.



Code

Model

60121-U
60123-U
60124-U
60127-U

TW2

COM Requirement

Back Shell & Seat Cushion = 2.5 yds.
Lower Side Panels = 1 yd.



Code

Model

60121-U
60123-U
60124-U
60127-U

TW3

COM Requirement

Back Shell & Lower Side Panels = 1.75 yds.
Seat Cushion = .75 yd.



Code

Model

60121-U
60123-U
60124-U
60127-U

TW4

COM Requirement

Inside Back Cushion & Seat Cushion = 1.5 yds.
Balance of Chair = 1.5 yds.



Code

Model

60121-W
60123-W
60124-W
60127-W

TW5

COM Requirement

Inside Back Cushion = 1 yd.
Balance of Chair = 1.25 yds.



Code

Model

60121-W
60123-W
60124-W
60127-W

TW6

COM Requirement

Inside Back Cushion & Seat Cushion = 1.5 yds.
Lower Side Panels = 1 yd.



Code

Model

60121-W
60123-W
60124-W
60127-W

TW7

COM Requirement

Inside Back Cushion & Lower Side Panels = 1.75 yds.
Seat Cushion = .75 yd.

All shipments for this series will be blanket-wrapped as standard. For customers located in Territory 1 who require cartoning, a 5% upcharge will be added to each product. Please contact client services for additional information.

TWIRL® LOUNGE | Designed by Chris & Jon Panichella



SPECIFICATIONS:

- Mid- and high back models available fully upholstered or with wood back shell.
- Wood back shell models feature upholstered back cushion and fully upholstered seat.
- Exposed plywood edge featured on wood back shell models.
- Edge finish on wood back shell models will match veneer finish as standard.
- Three base options: metal swivel, 4-leg wood and wood swivel.
- Swivel base models feature self-return.
- Metal swivel base offered in standard and premium finishes. See below for options.
- For custom metal finish colors, please contact client services for pricing.
- Wood offered in all standard and custom finishes on Ash.
- For Alabaster and Super Matte Sable Ash, premium wood finish upcharge applies. Refer to options section for pricing.
- For custom wood finishes, please contact client services and add one-time upcharge of \$531 List per color per order.
- 300 lb. weight capacity.
- All dimensions are nominal.
- Refer to terms and conditions for general information regarding fabrics, finishes, warranty, freight, complete condition of sales and more.

STANDARD METAL BASE FINISH COLORS:

- 0405 Charcoal Grey
- 0535 Metallic Silver
- 0299 Polished Aluminum
- 0630 Satin Black

PREMIUM METAL BASE FINISH COLORS:



- 0605 Matte Black
- 0705 Matte Cotton
- 0788 Glossy Cotton
- 0805 Oasis
- 0905 Mint
- 1005 Mercury
- 1105 Canary
- 1205 Stone
- 1305 Sage
- 1405 Ice Blue
- 1505 Clay

All shipments for this series will be blanket-wrapped as standard. For customers located in Territory 1 who require cartoning, a 5% upcharge will be added to each product. Please contact client services for additional information.

TWIRL® LOUNGE | Designed by Chris & Jon Panichella

ORDERING REQUIREMENTS:

- Model number
- Wood finish
- Base finish
- Upholstery selection
- Options, as applicable

| MODEL | PRODUCT SPECIFICATIONS | FABRIC GRADES | | | | | | | | | | LEATHER | |
|---|--|---------------|-------|-------|-------|-------|-------|----------|-------|-------|-------|---------|-------|
| | | COM | A | 1 | 2 | 3 | 4 | COL 5 | 6 | 7 | 8 | L1 | L2 |
| 60223-M-W  | Mid-Back Lounge Chair, Metal Swivel Base, Wood Back with Upholstered Cushion 29" W x 29.5" D x 32.75" H Seat: 19" W x 19" D Seat Ht: 16.5" COM: 2.5 yds. COL: 50 sq. ft. 35 lbs. | 2,512 | 2,682 | 2,772 | 2,827 | 2,915 | 3,010 | 3,095 | 3,182 | 3,270 | 3,360 | 3,772 | 4,072 |
| 60224-M-W  | Mid-Back Lounge Chair, 4-Leg Wood Base, Wood Back with Upholstered Cushion 29" W x 28.5" D x 32.75" H Seat: 19" W x 19" D Seat Ht: 16.5" COM: 2.5 yds. COL: 50 sq. ft. 34 lbs. | 2,599 | 2,769 | 2,859 | 2,914 | 3,002 | 3,097 | 3,182 | 3,269 | 3,357 | 3,447 | 3,859 | 4,159 |
| 60227-M-W  | Mid-Back Lounge Chair, Wood Swivel Base, Wood Back with Upholstered Cushion 29" W x 28.5" D x 32.75" H Seat: 19" W x 19" D Seat Ht: 16.5" COM: 2.5 yds. COL: 50 sq. ft. 37 lbs. | 2,796 | 2,966 | 3,056 | 3,111 | 3,199 | 3,294 | 3,379 | 3,466 | 3,554 | 3,644 | 4,056 | 4,356 |

OPTIONS



| | | |
|--------|--|-------|
| -PFM02 | Premium Metal Base Finish | \$101 |
| -PFW03 | Premium Wood Finish (wood back only) | \$34 |
| -PFW04 | Premium Wood Finish (wood back and base) | \$46 |
| -NSO4 | Non-Skid Glides | \$26 |

All shipments for this series will be blanket-wrapped as standard. For customers located in Territory 1 who require cartoning, a 5% upcharge will be added to each product. Please contact client services for additional information.

TWIRL® LOUNGE | Designed by Chris & Jon Panichella

ORDERING REQUIREMENTS:

- Model number
- Wood finish
- Base finish
- Upholstery selection
- Options, as applicable

| MODEL | PRODUCT SPECIFICATIONS | FABRIC GRADES | | | | | | | | LEATHER | | | |
|---|---|---------------|-------|-------|-------|-------|-------|----------|-------|---------|-------|-------|-------|
| | | COM | A | 1 | 2 | 3 | 4 | COL 5 | 6 | 7 | 8 | L1 | L2 |
| 60223-H-W  | High Back Lounge Chair, Metal Swivel Base, Wood Back with Upholstered Cushion 29" W x 32.25" D x 38.75" H Seat: 19" W x 19" D Seat Ht: 16.5" COM: 2.75 yds. COL: 55 sq. ft. 37 lbs. | 2,693 | 2,880 | 2,979 | 3,040 | 3,136 | 3,241 | 3,334 | 3,430 | 3,527 | 3,626 | 4,079 | 4,409 |
| 60224-H-W  | High Back Lounge Chair, 4-Leg Wood Base, Wood Back with Upholstered Cushion 29" W x 31.25" D x 38.75" H Seat: 19" W x 19" D Seat Ht: 16.5" COM: 2.75 yds. COL: 55 sq. ft. 36 lbs. | 2,777 | 2,964 | 3,063 | 3,124 | 3,220 | 3,325 | 3,418 | 3,514 | 3,611 | 3,710 | 4,163 | 4,493 |
| 60227-H-W  | High Back Lounge Chair, Wood Swivel Base, Wood Back with Upholstered Cushion 29" W x 31.25" D x 38.75" H Seat: 19" W x 19" D Seat Ht: 16.5" COM: 2.75 yds. COL: 55 sq. ft. 39 lbs. | 2,974 | 3,161 | 3,260 | 3,321 | 3,417 | 3,522 | 3,615 | 3,711 | 3,808 | 3,907 | 4,360 | 4,690 |

OPTIONS



| | | |
|--------|--|-------|
| -PFM02 | Premium Metal Base Finish | \$101 |
| -PFW03 | Premium Wood Finish (wood back only) | \$34 |
| -PFW04 | Premium Wood Finish (wood back and base) | \$46 |
| -NSO4 | Non-Skid Glides | \$26 |

All shipments for this series will be blanket-wrapped as standard. For customers located in Territory 1 who require cartoning, a 5% upcharge will be added to each product. Please contact client services for additional information.

TWIRL® LOUNGE | Designed by Chris & Jon Panichella

ORDERING REQUIREMENTS:

- Model number
- Base finish
- Upholstery selection
- Options, as applicable

| MODEL | PRODUCT SPECIFICATIONS | FABRIC GRADES | | | | | | | | | | LEATHER | |
|---|---|---------------|-------|-------|-------|-------|-------|----------|-------|-------|-------|---------|-------|
| | | COM | A | 1 | 2 | 3 | 4 | COL 5 | 6 | 7 | 8 | L1 | L2 |
| 60223-M-U  | Mid-Back Lounge Chair, Metal Swivel Base, Fully Upholstered 29.5" W x 29.75" D x 33" H Seat: 19" W x 19" D Seat Ht: 16.5" COM: 3 yds. COL: 60 sq. ft. 35 lbs. | 2,371 | 2,575 | 2,683 | 2,749 | 2,854 | 2,968 | 3,070 | 3,175 | 3,280 | 3,388 | 3,883 | 4,243 |
| 60224-M-U  | Mid-Back Lounge Chair, 4-Leg Wood Base, Fully Upholstered 29.5" W x 28.75" D x 33" H Seat: 19" W x 19" D Seat Ht: 16.5" COM: 3 yds. COL: 60 sq. ft. 34 lbs | 2,414 | 2,618 | 2,726 | 2,792 | 2,897 | 3,011 | 3,113 | 3,218 | 3,323 | 3,431 | 3,926 | 4,286 |
| 60227-M-U  | Mid-Back Lounge Chair, Wood Swivel Base, Fully Upholstered 29.5" W x 28.75" D x 33" H Seat: 19" W x 19" D Seat Ht: 16.5" COM: 3 yds. COL: 60 sq. ft. 37 lbs. | 2,610 | 2,814 | 2,922 | 2,988 | 3,093 | 3,207 | 3,309 | 3,414 | 3,519 | 3,627 | 4,122 | 4,482 |

OPTIONS



| | | |
|--------|---------------------------|-------|
| -PFM02 | Premium Metal Base Finish | \$101 |
| -PFW02 | Premium Wood Finish | \$23 |
| -NSO4 | Non-Skid Glides | \$26 |

All shipments for this series will be blanket-wrapped as standard. For customers located in Territory 1 who require cartoning, a 5% upcharge will be added to each product. Please contact client services for additional information.

TWIRL® LOUNGE | Designed by Chris & Jon Panichella

ORDERING REQUIREMENTS:

- Model number
- Base finish
- Upholstery selection
- Options, as applicable

| MODEL | PRODUCT SPECIFICATIONS | FABRIC GRADES | | | | | | | | LEATHER | | | |
|---|---|---------------|-------|-------|-------|-------|-------|----------|-------|---------|-------|-------|-------|
| | | COM | A | 1 | 2 | 3 | 4 | COL 5 | 6 | 7 | 8 | L1 | L2 |
| 60223-H-U  | High Back Lounge Chair, Metal Swivel Base, Fully Upholstered 29.5" W x 33" D x 39" H Seat: 19" W x 19" D Seat Ht: 16.5" COM: 3.5 yds. COL: 70 sq. ft. 37 lbs. | 2,472 | 2,710 | 2,836 | 2,913 | 3,036 | 3,169 | 3,288 | 3,410 | 3,533 | 3,659 | 4,236 | 4,656 |
| 60224-H-U  | High Back Lounge Chair, 4-Leg Wood Base, Fully Upholstered 29.5" W x 32" D x 39" H Seat: 19" W x 19" D Seat Ht: 16.5" COM: 3.5 yds. COL: 70 sq. ft. 36 lbs. | 2,558 | 2,796 | 2,922 | 2,999 | 3,122 | 3,255 | 3,374 | 3,496 | 3,619 | 3,745 | 4,322 | 4,742 |
| 60227-H-U  | High Back Lounge Chair, Wood Swivel Base, Fully Upholstered 29.5" W x 32" D x 39" H Seat: 19" W x 19" D Seat Ht: 16.5" COM: 3.5 yds. COL: 70 sq. ft. 39 lbs. | 2,755 | 2,993 | 3,119 | 3,196 | 3,319 | 3,452 | 3,571 | 3,693 | 3,816 | 3,942 | 4,519 | 4,939 |

OPTIONS

| | | |
|--------|---------------------------|-------|
| -PFM02 | Premium Metal Base Finish | \$101 |
| -PFW02 | Premium Wood Finish | \$23 |
| -NSO4 | Non-Skid Glides | \$26 |

TWIRL® LOUNGE | Designed by Chris & Jon Panichella

UPHOLSTERY COMBINATIONS:

- For upholstery combinations, refer to the pricing below.
- When combining two COM/COV/COL fabrics, or fabrics with the same grade, add \$120 List per unit.
- When combining three or more COM/COV/COL fabrics, or fabrics with the same grade, add \$150 List per unit.
- When combining different grades of fabric, price will be based on the highest grade specified.
- Two-tone upholstery examples and yardage requirements for the most common combinations are listed below. Additional combinations available; please contact client services for yardage requirements and pricing.
- Note: Yardage amounts are based on fabric which is plain (i.e. non-directional) and a full 54" wide.
- Appropriate upholstery code must be included.



| Code | TW8 |
|--------------|------------------------------|
| <u>Model</u> | <u>COM Requirement</u> |
| 60223-M-U | Back Shell = 1.5 yds. |
| 60224-M-U | Balance of Chair = 1.75 yds. |
| 60227-M-U | |

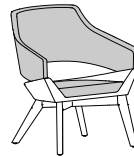

| Code | TW9 |
|--------------|--------------------------------------|
| <u>Model</u> | <u>COM Requirement</u> |
| 60223-M-U | Back Shell & Seat Cushion = 2.5 yds. |
| 60224-M-U | Lower Side Panels = 1.25 yds. |
| 60227-M-U | |



| Code | TW10 |
|--------------|---|
| <u>Model</u> | <u>COM Requirement</u> |
| 60223-M-U | Back Shell & Lower Side Panels = 2.5 yds. |
| 60224-M-U | Seat Cushion = .75 yd. |
| 60227-M-U | |

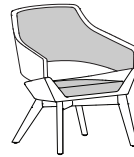

| Code | TW11 |
|--------------|---|
| <u>Model</u> | <u>COM Requirement</u> |
| 60223_M-U | Inside Back Cushion & Seat Cushion = 1.5 yds. |
| 60224-M-U | Balance of Chair = 1.5 yds. |
| 60227-M-U | |



| Code | TW12 |
|--------------|------------------------------|
| <u>Model</u> | <u>COM Requirement</u> |
| 60223-M-W | Inside Back Cushion = 1 yd. |
| 60224-M-W | Balance of Chair = 1.75 yds. |
| 60227-M-W | |



| Code | TW13 |
|--------------|---|
| <u>Model</u> | <u>COM Requirement</u> |
| 60223-M-W | Inside Back Cushion & Seat Cushion = 1.5 yds. |
| 60224-M-W | Lower Side Panels = 2 yds. |
| 60227-M-W | |



| Code | TW14 |
|--------------|--|
| <u>Model</u> | <u>COM Requirement</u> |
| 60223-M-W | Inside Back Cushion & Lower Side Panels = 2 yds. |
| 60224-M-W | Seat Cushion = .75 yd. |
| 60227-M-W | |

TWIRL® LOUNGE | Designed by Chris & Jon Panichella

UPHOLSTERY COMBINATIONS:

- For upholstery combinations, refer to the pricing below.
- When combining two COM/COV/COL fabrics, or fabrics with the same grade, add \$120 List per unit.
- When combining three or more COM/COV/COL fabrics, or fabrics with the same grade, add \$150 List per unit.
- When combining different grades of fabric, price will be based on the highest grade specified.
- Two-tone upholstery examples and yardage requirements for the most common combinations are listed below. Additional combinations available; please contact client services for yardage requirements and pricing.
- Note: Yardage amounts are based on fabric which is plain (i.e. non-directional) and a full 54" wide.
- Appropriate upholstery code must be included.

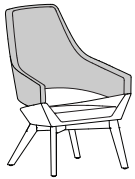

Code
Model
60223-H-U
60224-H-U
60227-H-U

TW15
COM Requirement
Back Shell = 1.75 yd.
Balance of Chair = 1.75 yds.

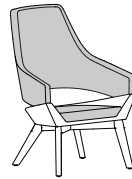

Code
Model
60223-H-U
60224-H-U
60227-H-U

TW16
COM Requirement
Back Shell & Seat Cushion = 2.75 yds.
Lower Side Panels = 1.25 yds.

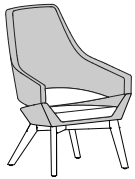

Code
Model
60223-H-U
60224-H-U
60227-H-U

TW17
COM Requirement
Back Shell & Lower Side Panels = 2.75 yds.
Seat Cushion = 1 yd.

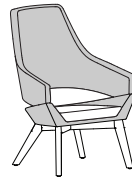

Code
Model
60223-H-U
60224-H-U
60227-H-U

TW18
COM Requirement
Inside Back Cushion & Seat Cushion = 1.75 yds.
Balance of Chair = 1.5 yds.

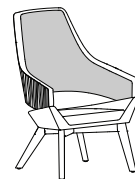

Code
Model
60223-H-W
60224-H-W
60227-H-W

TW19
COM Requirement
Inside Back Cushion = 1 yd.
Balance of Chair = 1.75 yds.



Code
Model
60223-H-W
60224-H-W
60227-H-W

TW20
COM Requirement
Inside Back Cushion & Seat Cushion = 1.75 yds.
Lower Side Panels = 1.5 yds.

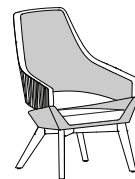

Code
Model
60223-H-W
60224-H-W
60227-H-W

TW21
COM Requirement
Inside Back Cushion & Lower Side Panels = 2.25 yds.
Seat Cushion = .75 yd.

All shipments for this series will be blanket-wrapped as standard. For customers located in Territory 1 who require cartoning, a 5% upcharge will be added to each product. Please contact client services for additional information.

VISOR LOUNGE | Designed by 5d Studio



SPECIFICATIONS:

- Lounge and love seat models available in Public and Private options.
- Sled base available in four standard finishes: 0405 Charcoal Grey, 0535 Metallic Silver, 0199 Chrome and 0630 Satin Black.
- Premium finishes also available.
- Swivel base lounge chair also offered.
- Swivel base is finished in stainless steel and features 360-degree turning radius with self-return.
- Lounge unit weight capacity: 350 lbs. Love seat weight capacity: 700 lbs.
- Optional contrasting welt offered on Private panels.
- Non-skid glides available for hard surface floors.
- All dimensions are nominal.
- Refer to terms and conditions for general information regarding fabrics, finishes, warranty, freight, complete condition of sales and more.

ROTATING TABLET:

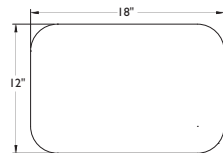

- Tablet is .75" thick, features 360-degree turning radius and is available on all Public seating units.
- Two surface options: laminate and solid surface.
- For standard wood grain laminate or solid black laminate tops, edge will match unless specified otherwise.
- For all other solid laminates, edge will be exposed plywood substrate with clear coat finish.
- For non-standard laminates, add \$649 List per color per order. Pre-approval required, please contact client services.
- Solid surface available in white only.
- Solid surface tops feature exposed plywood substrate edge with clear coat finish.
- Tablet mounting bracket will match corresponding seating unit base finish unless specified otherwise.
- 100 lb. weight capacity.

All shipments for this series will be blanket-wrapped as standard. For customers located in Territory 1 who require cartoning, a 5% upcharge will be added to each product. Please contact client services for additional information.

VISOR LOUNGE | Designed by 5d Studio

CUP HOLDER:

- Available on Private lounge units.
- Dimensions: 5" outer diameter, 3.5" inner diameter (cup size) x .25" deep.
- 0299 Polished Aluminum finish with black laminate inserts.

STANDARD METAL BASE FINISH COLORS:

- 0405 Charcoal Grey
- 0535 Metallic Silver
- 0199 Chrome (sled base only)
- 0399 Polished Stainless Steel (swivel base only)
- 0630 Satin Black

PREMIUM METAL BASE FINISH COLORS:



- 0605 Matte Black
- 0705 Matte Cotton
- 0788 Glossy Cotton
- 0805 Oasis
- 0905 Mint
- 1005 Mercury
- 1105 Canary
- 1205 Stone
- 1305 Sage
- 1405 Ice Blue
- 1505 Clay

All shipments for this series will be blanket-wrapped as standard. For customers located in Territory 1 who require cartoning, a 5% upcharge will be added to each product. Please contact client services for additional information.

VISOR LOUNGE | Designed by 5d Studio

ORDERING REQUIREMENTS:

- Model number
- Upholstery selection
- Options, as applicable

| MODEL | PRODUCT SPECIFICATIONS | FABRIC GRADES | | | | | | | | | | LEATHER | |
|---|---|---------------|-------|-------|-------|-------|-------|----------|-------|-------|-------|---------|-------|
| | | COM | A | 1 | 2 | 3 | 4 | COL 5 | 6 | 7 | 8 | L1 | L2 |
| 7725  | Public Lounge, Swivel Base 27.5" W x 28.5" D x 31.5" H Seat: 27.5" W x 19" D Seat Ht: 17.5" COM: 2 yds. COL: 40 sq. ft. 74 lbs. | 1,757 | 1,893 | 1,965 | 2,009 | 2,079 | 2,155 | 2,223 | 2,293 | 2,363 | 2,435 | 2,765 | 3,005 |
| 7725-SP  | Semi-Private Lounge, Swivel Base 29.5" W x 30" D x 47.5" H Seat: 27.5" W x 19" D Seat Ht: 17.5" COM: 4.5 yds. COL: 90 sq. ft. 99 lbs. | 2,627 | 2,933 | 3,095 | 3,194 | 3,352 | 3,523 | 3,676 | 3,833 | 3,991 | 4,153 | 4,895 | 5,435 |
| 7725-PR  | Private Lounge, Swivel Base 31.5" W x 30" D x 47.5" H Seat: 27.5" W x 19" D Seat Ht: 17.5" COM: 6 yds. COL: 120 sq. ft. 103 lbs. | 2,690 | 3,098 | 3,314 | 3,446 | 3,656 | 3,884 | 4,088 | 4,298 | 4,508 | 4,724 | 5,714 | 6,434 |
| XXXX-XX-CW | Privacy Panel Contrasting Welt COM: 1 yd. COL: n/a | 188 | 256 | 292 | 314 | 349 | 387 | 421 | 456 | 491 | 527 | | |

OPTIONS - PUBLIC AND SEMI-PRIVATE MODELS

| | | |
|-----------|--|-------|
| -TAR03-L | Laminate Rotating Tablet, Right (as seated) | \$629 |
| -TAL03-L | Laminate Rotating Tablet, Left (as seated) | \$629 |
| -TAR03-SF | Solid Surface Rotating Tablet, Right (as seated) | \$692 |
| -TAL03-SF | Solid Surface Rotating Tablet, Left (as seated) | \$692 |
| -MB01 | Moisture Barrier (seat only) | \$68 |

OPTIONS - PRIVATE MODELS



| | | |
|--------|-------------------------------|-------|
| -CHR02 | Cup Holder, Right (as seated) | \$205 |
| -CHL02 | Cup Holder, Left (as seated) | \$205 |
| -MB01 | Moisture Barrier (seat only) | \$68 |

All shipments for this series will be blanket-wrapped as standard. For customers located in Territory 1 who require cartoning, a 5% upcharge will be added to each product. Please contact client services for additional information.

VISOR LOUNGE | Designed by 5d Studio

ORDERING REQUIREMENTS:

- Model number
- Base finish
- Upholstery selection
- Options, as applicable

| MODEL | PRODUCT SPECIFICATIONS | FABRIC GRADES | | | | | | | | | | LEATHER | |
|---|---|---------------|-------|-------|-------|-------|-------|----------|-------|-------|-------|---------|-------|
| | | COM | A | 1 | 2 | 3 | 4 | COL 5 | 6 | 7 | 8 | L1 | L2 |
| 7701  | Public Lounge, Sled Base 27.5" W x 28.5" D x 31.5" H Seat: 27.5" W x 19" D Seat Ht: 17.5" COM: 2 yds. COL: 40 sq. ft. 30 lbs. | 1,435 | 1,571 | 1,643 | 1,687 | 1,757 | 1,833 | 1,901 | 1,971 | 2,041 | 2,113 | 2,443 | 2,683 |
| 7701-SP  | Semi-Private Lounge, Sled Base 29.5" W x 30" D x 47.5" H Seat: 27.5" W x 19" D Seat Ht: 17.5" COM: 4.5 yds. COL: 90 sq. ft. 53 lbs. | 2,302 | 2,608 | 2,770 | 2,869 | 3,027 | 3,198 | 3,351 | 3,508 | 3,666 | 3,828 | 4,570 | 5,110 |
| 7701-PR  | Private Lounge, Sled Base 31.5" W x 30" D x 47.5" H Seat: 27.5" W x 19" D Seat Ht: 17.5" COM: 6 yds. COL: 120 sq. ft. 58 lbs. | 2,366 | 2,774 | 2,990 | 3,122 | 3,332 | 3,560 | 3,764 | 3,974 | 4,184 | 4,400 | 5,390 | 6,110 |
| XXXX-XX-CW | Privacy Panel Contrasting Welt COM: 1 yd. COL: n/a | 188 | 256 | 292 | 314 | 349 | 387 | 421 | 456 | 491 | 527 | | |

OPTIONS - PUBLIC AND SEMI-PRIVATE MODELS

| | | |
|-----------|--|-------|
| -PFM02 | Premium Metal Base Finish | \$101 |
| -NS04 | Non-Skid Glides | \$26 |
| -MB01 | Moisture Barrier (seat only) | \$68 |
| -TAR03-L | Laminate Rotating Tablet, Right (as seated) | \$629 |
| -TAL03-L | Laminate Rotating Tablet, Left (as seated) | \$629 |
| -TAR03-SF | Solid Surface Rotating Tablet, Right (as seated) | \$692 |
| -TAL03-SF | Solid Surface Rotating Tablet, Left (as seated) | \$692 |

OPTIONS - PRIVATE MODELS



| | | |
|--------|-------------------------------|-------|
| -PFM02 | Premium Metal Base Finish | \$101 |
| -CHR02 | Cup Holder, Right (as seated) | \$205 |
| -CHL02 | Cup Holder, Left (as seated) | \$205 |
| -NS04 | Non-Skid Glides | \$26 |
| -MB01 | Moisture Barrier (seat only) | \$68 |

All shipments for this series will be blanket-wrapped as standard. For customers located in Territory 1 who require cartoning, a 5% upcharge will be added to each product. Please contact client services for additional information.

VISOR LOUNGE | Designed by 5d Studio

ORDERING REQUIREMENTS:

- Model number
- Base finish
- Upholstery selection
- Options, as applicable

| MODEL | PRODUCT SPECIFICATIONS | FABRIC GRADES | | | | | | | | | | LEATHER | |
|---|---|---------------|-------|-------|-------|-------|-------|----------|-------|-------|-------|---------|-------|
| | | COM | A | 1 | 2 | 3 | 4 | COL 5 | 6 | 7 | 8 | L1 | L2 |
| 7702  | Public Love Seat 45" W x 28.5" D x 31.5" H Seat: 45" W x 19" D Seat Ht: 17.5" COM: 2.75 yds. COL: 55 sq. ft. 44 lbs. | 2,068 | 2,255 | 2,354 | 2,415 | 2,511 | 2,616 | 2,709 | 2,805 | 2,902 | 3,001 | 3,454 | 3,784 |
| 7702-SP  | Semi-Private Love Seat 47" W x 30" D x 47.5" H Seat: 45" W x 19" D Seat Ht: 17.5" COM: 5.75 yds. COL: 115 sq. ft. 68 lbs. | 3,098 | 3,489 | 3,696 | 3,823 | 4,024 | 4,243 | 4,438 | 4,639 | 4,841 | 5,048 | 5,996 | 6,686 |
| 7702-PR  | Private Love Seat 49" W x 30" D x 47.5" H Seat: 45" W x 19" D Seat Ht: 17.5" COM: 6.5 yds. COL: 130 sq. ft. 80 lbs. | 3,162 | 3,604 | 3,838 | 3,981 | 4,209 | 4,456 | 4,677 | 4,904 | 5,132 | 5,366 | 6,438 | 7,218 |
| XXXX-XX-CW | Privacy Panel Contrasting Welt COM: 1 yd. COL: n/a | 257 | 325 | 361 | 383 | 418 | 456 | 490 | 525 | 560 | 596 | | |

OPTIONS - PUBLIC AND SEMI-PRIVATE MODELS

| | | |
|-----------|--|-------|
| -PFM02 | Premium Metal Base Finish | \$101 |
| -NS04 | Non-Skid Glides | \$26 |
| -MB02 | Moisture Barrier (seat only) | \$89 |
| -TAR03-L | Laminate Rotating Tablet, Right (as seated) | \$629 |
| -TAL03-L | Laminate Rotating Tablet, Left (as seated) | \$629 |
| -TAR03-SF | Solid Surface Rotating Tablet, Right (as seated) | \$692 |
| -TAL03-SF | Solid Surface Rotating Tablet, Left (as seated) | \$692 |

OPTIONS - PRIVATE MODELS

| | | |
|--------|-------------------------------|-------|
| -PFM02 | Premium Metal Base Finish | \$101 |
| -CHR02 | Cup Holder, Right (as seated) | \$205 |
| -CHL02 | Cup Holder, Left (as seated) | \$205 |
| -NS04 | Non-Skid Glides | \$26 |
| -MB02 | Moisture Barrier (seat only) | \$89 |

VISOR LOUNGE | Designed by 5d Studio

UPHOLSTERY COMBINATIONS:

- For upholstery combinations, refer to the pricing below.
- When combining two COM/COV/COL fabrics, or fabrics with the same grade, add \$120 List per unit.
- When combining three or more COM/COV/COL fabrics, or fabrics with the same grade, add \$150 List per unit.
- When combining different grades of fabric, price will be based on the highest grade specified.
- Two-tone upholstery examples and yardage requirements for the most common combinations are listed below. Additional combinations available; please contact client services for yardage requirements and pricing.
- Note: Yardage amounts are based on fabric which is plain (i.e. non-directional) and a full 54" wide.
- Appropriate upholstery code must be included.



Code VS1
Model COM Requirement
 7725 Seat = 1 yd.
 Back = 1.5 yds.



Code VS2
Model COM Requirement
 7725-SP Seat & Back = 2.5 yds.
 Privacy Panel = 2.5 yds.

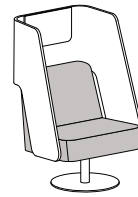

Code VS3
Model COM Requirement
 7725-PR Seat & Back = 2.5 yds.
 Privacy Panel = 4 yds.

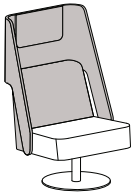

Code VS4
Model COM Requirement
 7725-SP Seat = 1 yd.
 Privacy Panel & Back = 4 yds.

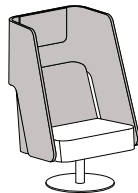

Code VS5
Model COM Requirement
 7725-PR Seat = 1 yd.
 Privacy Panel & Back = 5.5 yds.

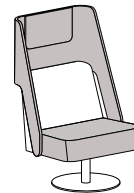

Code VS6
Model COM Requirement
 7725-SP Seat & Privacy Panel = 3.5 yds.
 Back = 1.5 yds.

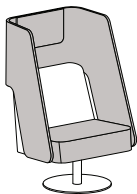

Code VS7
Model COM Requirement
 7725-PR Seat & Privacy Panel = 5 yds.
 Back = 1.5 yds.



Code VS8
Model COM Requirement
 7701 Seat = 1 yds.
 7701-M Back = 1.5 yds.

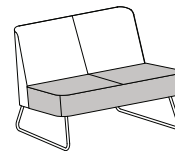

Code VS9
Model COM Requirement
 7702 Seat = 1.5 yds.
 7702-M Back = 1.5 yds.

VISOR LOUNGE | Designed by 5d Studio

UPHOLSTERY COMBINATIONS:

- For upholstery combinations, refer to the pricing below.
- When combining two COM/COV/COL fabrics, or fabrics with the same grade, add \$120 List per unit.
- When combining three or more COM/COV/COL fabrics, or fabrics with the same grade, add \$150 List per unit.
- When combining different grades of fabric, price will be based on the highest grade specified.
- Two-tone upholstery examples and yardage requirements for the most common combinations are listed below. Additional combinations available; please contact client services for yardage requirements and pricing.
- Note: Yardage amounts are based on fabric which is plain (i.e. non-directional) and a full 54" wide.
- Appropriate upholstery code must be included.

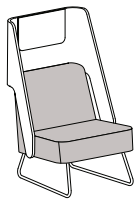

Code VS10
Model COM Requirement
 7701-SP Seat & Back = 2.5 yds.
 Privacy Panel = 2.5 yds.

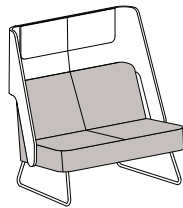

Code VS11
Model COM Requirement
 7702-SP Seat & Back = 3 yds.
 Privacy Panel = 3 yds.

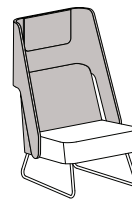

Code VS12
Model COM Requirement
 7701-SP Seat = 1 yd.
 Privacy Panel & Back = 4 yds.

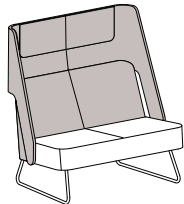

Code VS13
Model COM Requirement
 7702-SP Seat = 1.5 yds.
 Privacy Panel & Back = 5 yds.

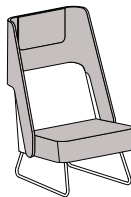

Code VS14
Model COM Requirement
 7701-SP Seat & Privacy Panel = 3.5 yds.
 Back = 1.5 yds.

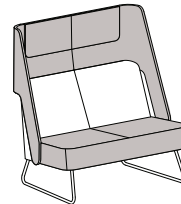

Code VS15
Model COM Requirement
 7702-SP Seat & Privacy Panel = 4.5 yds.
 Back = 1.5 yds.

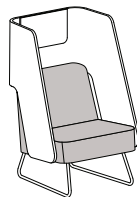

Code VS16
Model COM Requirement
 7701-PR Seat & Back = 2.5 yds.
 Privacy Panel = 4 yds.

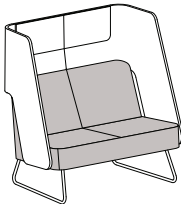

Code VS17
Model COM Requirement
 7702-PR Seat & Back = 3 yds.
 Privacy Panel = 4 yds.

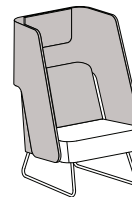

Code VS18
Model COM Requirement
 7701-PR Seat = 1 yd.
 Privacy Panel & Back = 5.5 yds.

VISOR LOUNGE | Designed by 5d Studio

UPHOLSTERY COMBINATIONS:

- For upholstery combinations, refer to the pricing below.
- When combining two COM/COV/COL fabrics, or fabrics with the same grade, add \$120 List per unit.
- When combining three or more COM/COV/COL fabrics, or fabrics with the same grade, add \$150 List per unit.
- When combining different grades of fabric, price will be based on the highest grade specified.
- Two-tone upholstery examples and yardage requirements for the most common combinations are listed below. Additional combinations available; please contact client services for yardage requirements and pricing.
- Note: Yardage amounts are based on fabric which is plain (i.e. non-directional) and a full 54" wide.
- Appropriate upholstery code must be included.

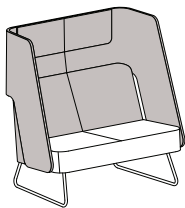

Code VS19
Model 7702-PR
COM Requirement
Seat = 1.5 yds.
Privacy Panel & Back = 5.5 yds.

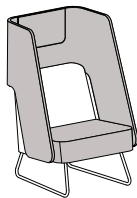

Code VS20
Model 7701-PR
COM Requirement
Seat & Privacy Panel = 5 yds.
Back = 1.5 yds.

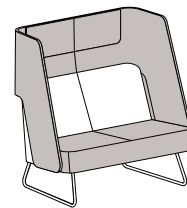

Code VS21
Model 7702-PR
COM Requirement
Seat & Privacy Panel = 5.5 yds.
Back = 1.5 yds.

All shipments for this series will be blanket-wrapped as standard. For customers located in Territory 1 who require cartoning, a 5% upcharge will be added to each product. Please contact client services for additional information.

WAKE STOOLS | Designed by Chris Panichella



SPECIFICATIONS:

- Two seated heights: 25" and 30".
- Fully upholstered and sculpted plywood seat models available.
- Three wood species available: Beech, White Oak and Walnut.
- Available in all standard wood finishes.
- Premium wood finish upcharge applies to the following wood finishes. Refer to option section for pricing.
 - Super Matte Sable Beech
 - Alabaster Oak
 - Super Matte Sable Oak
- 1/2" diameter steel rod frame.
- Frame available in standard and premium finishes. Please refer to listing below.
- All models stack up to 5 high.
- 350 lb. weight capacity.
- Optional clear glides for hard surface flooring.
- All dimensions are nominal.
- Refer to terms and conditions for general information regarding fabrics, finishes, warranty, freight, complete condition of sales and more.

STANDARD METAL FRAME FINISH COLORS:

- 0405 Charcoal Grey
- 0535 Metallic Silver
- 0199 Chrome
- 0630 Satin Black

PREMIUM METAL FRAME FINISH COLORS:



- 0605 Matte Black
- 0705 Matte Cotton
- 0788 Glossy Cotton
- 0805 Oasis
- 0905 Mint
- 1005 Mercury
- 1105 Canary
- 1205 Stone
- 1305 Sage
- 1405 Ice Blue
- 1505 Clay

All shipments for this series will be blanket-wrapped as standard. For customers located in Territory 1 who require cartoning, a 5% upcharge will be added to each product. Please contact client services for additional information.

WAKE STOOLS | Designed by Chris Panichella

ORDERING REQUIREMENTS:

- Model number
- Wood finish
- Frame finish
- Options, as applicable

| MODEL | PRODUCT SPECIFICATIONS | LIST |
|--|---|------|
| 1110-25  | 25" Height Stool, Wood Seat 21.25" W x 20" D x 25.5" H Seat: 16.75" W x 16.25" Seat Ht: 25" 18 lbs. | 847 |
| 1110-30  |  30" Height Stool, Wood Seat 21.25" W x 20" D x 31.25" H Seat: 16.75" W x 16.25" D Seat Ht: 30" 20 lbs. | 854 |

OPTIONS

| | | |
|--------|----------------------------|-------|
| -PFM02 | Premium Metal Frame Finish | \$101 |
| -PFW02 | Premium Wood Finish | \$23 |
| -CG02 | Clear Glides (Set of 4) | \$12 |

 = Available on quick-ship program (0535 Metallic Silver and 0199 Chrome frame with standard wood finishes only).

All shipments for this series will be blanket-wrapped as standard. For customers located in Territory 1 who require cartoning, a 5% upcharge will be added to each product. Please contact client services for additional information.

WAKE STOOLS | Designed by Chris Panichella

ORDERING REQUIREMENTS:

- Model number
- Wood finish
- Frame finish
- Upholstery selection
- Options, as applicable

| MODEL | PRODUCT SPECIFICATIONS | FABRIC GRADES | | | | | | | | | | LEATHER | |
|---------|---|---------------|-------|-------|-------|-------|-------|----------|-------|-------|-------|---------|-------|
| | | COM | A | 1 | 2 | 3 | 4 | COL 5 | 6 | 7 | 8 | L1 | L2 |
| 1120-25 | 25" Counter-Height Stool, Wood Seat with Upholstered Cushion 21.25" W x 20" D x 25.5" H Seat: 16.75" W x 16.25" D Seat Ht: 25" COM: .75 yd. COL: 15 sq. ft. 19 lbs. | 951 | 1,002 | 1,029 | 1,046 | 1,072 | 1,101 | 1,126 | 1,152 | 1,179 | 1,206 | 1,329 | 1,419 |
| 1120-30 |  30" Bar-Height Stool, Wood Seat with Upholstered Cushion 21.25" W x 20" D x 31.25" H Seat: 16.75" W x 16.25" D Seat Ht: 30.5" COM: .75 yd. COL: 15 sq. ft. 21 lbs. | 956 | 1,007 | 1,034 | 1,051 | 1,077 | 1,106 | 1,131 | 1,157 | 1,184 | 1,211 | 1,334 | 1,424 |

OPTIONS

- PFM02 Premium Metal Frame Finish \$101
- PFW02 Premium Wood Finish \$23
- CG02 Clear Glides (Set of 4) \$12



 = Available on quick-ship program (0535 Metallic Silver and 0199 Chrome frame with standard wood finishes only).

All shipments for this series will be blanket-wrapped as standard. For customers located in Territory 1 who require cartoning, a 5% upcharge will be added to each product. Please contact client services for additional information.

WAKE STOOLS | Designed by Chris Panichella

ORDERING REQUIREMENTS:

- Model number
- Frame finish
- Upholstery selection
- Options, as applicable

| MODEL | PRODUCT SPECIFICATIONS | FABRIC GRADES | | | | | | | | | | LEATHER | |
|---|--|---------------|-----|-------|-------|-------|-------|----------|-------|-------|-------|---------|-------|
| | | COM | A | 1 | 2 | 3 | 4 | COL 5 | 6 | 7 | 8 | L1 | L2 |
| 1130-25  | 25" Counter-Height Stool, Fully Upholstered Seat 21.25" W x 20" D x 25.5" H Seat: 16.75" W x 16.25" D Seat Ht: 25" COM: .75 yd. COL: 15 sq. ft. 19 lbs. | 915 | 966 | 993 | 1,010 | 1,036 | 1,065 | 1,090 | 1,116 | 1,143 | 1,170 | 1,293 | 1,383 |
| 1130-30  |  30" Bar-Height Stool, Fully Upholstered Seat 21.25" W x 20" D x 31.25" H Seat: 16.75" W x 16.25" D Seat Ht: 30.5" COM: .75 yd. COL: 15 sq. ft. 21 lbs. | 922 | 973 | 1,000 | 1,017 | 1,043 | 1,072 | 1,097 | 1,123 | 1,150 | 1,177 | 1,300 | 1,390 |

OPTIONS

- PFM02 Premium Metal Frame Finish \$101
- CG02 Clear Glides (Set of 4) \$12

 = Available on quick-ship program (0535 Metallic Silver and 0199 Chrome frame finishes only).